

Colour	Transparent	Material	PVC
Conduits Ø (mm)	40	Electrocod	210

### DIMENSIONAL

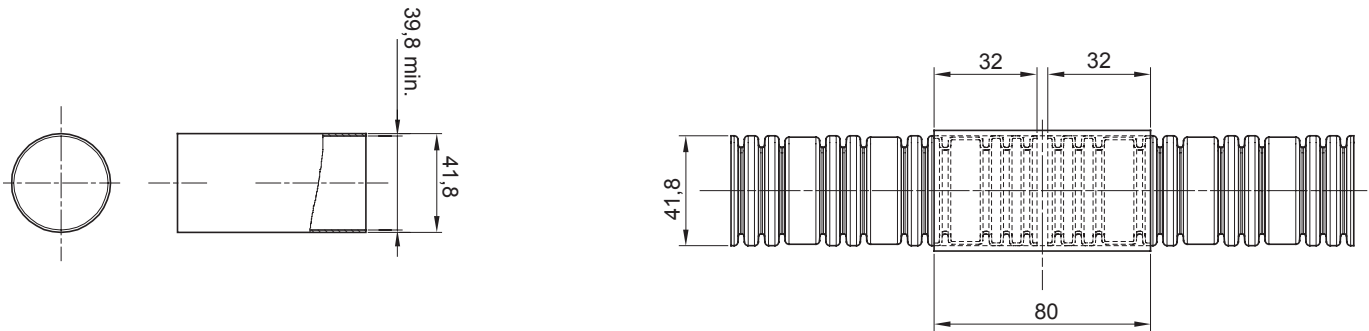

### STANDARDS/APPROVALS

