

# **Agilent 34450A** **5½ Digit Multimeter**

## **User's Guide**



**Agilent Technologies**

## Notices

© Agilent Technologies, Inc. 2012–2013

No part of this manual may be reproduced in any form or by any means (including electronic storage and retrieval or translation into a foreign language) without prior agreement and written consent from Agilent Technologies, Inc. as governed by United States and international copyright laws.

### Manual Part Number

34450-90000

### Edition

Third Edition, July 21, 2013

Agilent Technologies, Inc.  
5301 Stevens Creek Blvd.  
Santa Clara, CA 95051 USA

Microsoft® is a U.S. registered trademark of Microsoft Corporation.

### Software Revision

This guide is valid for A.01.xx revisions of the Agilent 34450A 5½ Digit Multimeter software, where xx refers to minor revisions of the software that do not affect the technical accuracy of this guide.

## Warranty

**The material contained in this document is provided “as is,” and is subject to being changed, without notice, in future editions. Further, to the maximum extent permitted by applicable law, Agilent disclaims all warranties, either express or implied, with regard to this manual and any information contained herein, including but not limited to the implied warranties of merchantability and fitness for a particular purpose. Agilent shall not be liable for errors or for incidental or consequential damages in connection with the furnishing, use, or performance of this document or of any information contained herein. Should Agilent and the user have a separate written agreement with warranty terms covering the material in this document that conflict with these terms, the warranty terms in the separate agreement shall control.**

## Technology Licenses

The hardware and/or software described in this document are furnished under a license and may be used or copied only in accordance with the terms of such license.

## Restricted Rights Legend

U.S. Government Restricted Rights. Software and technical data rights granted to the federal government include only those rights customarily provided to end user customers. Agilent provides this customary commercial license in Software and technical data pursuant to FAR 12.211 (Technical Data) and 12.212 (Computer Software) and, for the Department of Defense, DFARS 252.227-7015 (Technical Data - Commercial Items) and DFARS 227.7202-3 (Rights in Commercial Computer Software or Computer Software Documentation).

## Safety Notices

### CAUTION

A **CAUTION** notice denotes a hazard. It calls attention to an operating procedure, practice, or the like that, if not correctly performed or adhered to, could result in damage to the product or loss of important data. Do not proceed beyond a **CAUTION** notice until the indicated conditions are fully understood and met.

---





### WARNING

A **WARNING** notice denotes a hazard. It calls attention to an operating procedure, practice, or the like that, if not correctly performed or adhered to, could result in personal injury or death. Do not proceed beyond a **WARNING** notice until the indicated conditions are fully understood and met.





---

## Safety Symbols

The following symbols on the instrument and in the documentation indicate precautions that must be taken to maintain safe operation of the instrument.

	Earth (ground) terminal
	Caution, risk of electric shock
	Frame or chassis terminal
	Caution, risk of danger (refer to this manual for specific Warning or Caution information)
<b>CAT II 300 V</b>	IEC Measurement Category II. Inputs may be connected to mains (up to 300 VAC) under Category II overvoltage conditions.

## Regulatory Markings

	<p>The CE mark is a registered trademark of the European Community. This CE mark shows that the product complies with all the relevant European Legal Directives.</p>		<p>The C-tick mark is a registered trademark of the Spectrum Management Agency of Australia. This signifies compliance with the Australia EMC Framework regulations under the terms of the Radio Communication Act of 1992.</p>
<p><b>ICES/NMB-001</b></p>	<p>ICES/NMB-001 indicates that this ISM device complies with the Canadian ICES-001. Cet appareil ISM est conforme a la norme NMB-001 du Canada.</p>		<p>This instrument complies with the WEEE Directive (2002/96/EC) marking requirement. This affixed product label indicates that you must not discard this electrical/electronic product in domestic household waste.</p>
	<p>The CSA mark is a registered trademark of the Canadian Standards Association.</p>		<p>This symbol indicates the time period during which no hazardous or toxic substance elements are expected to leak or deteriorate during normal use. Forty years is the expected useful life of the product.</p>

## General Safety Information

The following general safety precautions must be observed during all phases of operation, service, and repair of this instrument. Failure to comply with these precautions or with specific warnings elsewhere in this manual violates safety standards of design, manufacture, and intended use of the instrument. Agilent Technologies assumes no liability for the customer's failure to comply with these requirements.

### WARNING

- **Do not defeat the power cord safety ground feature. Plug in to a grounded (earthed) outlet.**
- **Do not use the instrument in any manner that is not specified by the manufacturer.**
- **To avoid electric shock or injury, do not operate the multimeter without panels or case in place.**
- **Do not substitute parts or modify the instrument to avoid the danger of introducing additional hazards. Return the instrument to Agilent Technologies Sales and Service Office for service and repair to ensure the safety features are maintained.**
- **Main Power and Test Input Disconnect: Unplug the instrument from the wall outlet, remove the power cord, and remove all probes from all terminals before servicing. Only qualified, service-trained personnel should remove the cover from the instrument.**
- **Line and Current Protection Fuses: For continued protection against fire, replace the line fuse and the current-protection fuse only with fuses of the specified type and rating.**
- **IEC Measurement Category II. The HI and LO input terminals may be connected to mains in IEC Category II installations for line voltages up to 300 VAC. To avoid the danger of electric shock, do not connect the inputs to mains for line voltages above 300 VAC. See "IEC Measurement Category II Overvoltage Protection" on the following page for further information.**
- **Protection limits: To avoid instrument damage and the risk of electric shock, do not exceed any of the Protection Limits defined in the following section.**
- **If the Test Lead Set is used in a manner not specified by Agilent Technologies, the protection provided by the Test Lead Set may be impaired. Also, do not use a damaged or worn Test Lead Set. Instrument damage or personal injury may result.**

## Protection Limits

The Agilent 34450A 5½ Digital Multimeter provides protection circuitry to prevent damage to the instrument and to protect against the danger of electric shock, provided that the Protection Limits are not exceeded. To ensure safe operation of the instrument, do not exceed the Protection Limits shown on the front panel, as defined below:

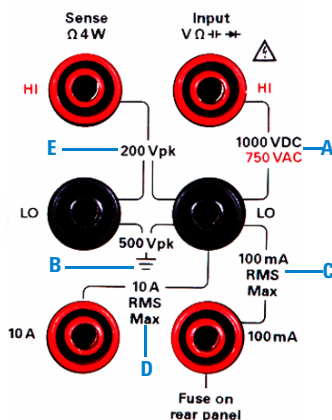

**Note:** The front-panel terminals and current protection fuse are shown above.

## Input Terminal Protection Limits

Protection Limits are defined for the input terminals:

**Main Input (HI and LO) Terminals.** The HI and LO input terminals are used for voltage, resistance, capacitance, and diode test measurements. Two Protection Limits are defined for these terminals:

**HI to LO Protection Limit.** The Protection Limit from HI to LO ("A" in the figure above) is 1000 VDC or 750 VAC, which is also the maximum voltage measurement. This limit can also be expressed as 1000 Vpk maximum.

**LO to Ground Protection Limit.** The LO input terminal can safely "float" a maximum of 500 Vpk relative to ground. This is Protection Limit "B" in the figure.

Although not shown on the figure, the Protection Limit for the HI terminal is a maximum of 1000 Vpk relative to the ground. Therefore, the sum of the "float" voltage and the measured voltage must not exceed 1000 Vpk

**Current Input Terminal.** The current input ("I") terminal has a Protection Limit of 100 mA (rms) maximum current flowing from the LO input terminal. This is Protection Limit "C" in the figure. Note that the current input terminal will be at approximately the same voltage as the LO terminal.

**Note:** The current-protection circuitry includes a fuse on the back panel. To maintain protection, replace this fuse only with a fuse of the specified type and rating.

**10 A Current Input Terminal.** The 10 A current input terminal has a Protection Limit of 10 A (rms) maximum current flowing from the LO input terminal. This is Protection Limit "D" in the figure. Note that the current input terminal will be at approximately the same voltage as the LO terminal.

**Note:** The current-protection circuitry includes an internal fuse. To maintain protection, service-trained personnel should replace this fuse only with a fuse of the specified type and rating.

## Sense Terminal Protection Limits

The HI and LO sense terminals are used only for four-wire resistance measurements (" $\Omega$  4W"). The Protection Limit is 200 Vpk for all of the terminal pairings ("E" in the figure):

LO sense to LO input.  
HI sense to LO input.  
HI sense to LO sense.

**Note:** The 200 Vpk limit on the sense terminals is the Protection Limit. Operational voltages in resistance measurements are much lower - less than 5 V in normal operation.

## IEC Measurement Category II Overvoltage Protection

To protect against the danger of electric shock, the Agilent 34450A 5½ Digital Multimeter provides overvoltage protection for line-voltage mains connections meeting *both* of the following conditions:

The HI and LO input terminals are connected to the mains under Measurement Category II conditions, defined below, *and*

The mains are limited to a maximum line voltage of 300 VAC.

IEC Measurement Category II includes electrical devices connected to mains at an outlet on a branch circuit. Such devices include most small appliances, test equipment, and other devices that plug into a branch outlet or socket. The 34450A may be used to make measurements with the HI and LO inputs connected to mains in such devices, or to the branch outlet itself (up to 300 VAC). However, the 34450A may not be used with its HI and LO inputs connected to mains in permanently installed electrical devices such as the main circuit-breaker panel, sub-panel disconnect boxes, or permanently wired motors. Such devices and circuits are subject to overvoltages that may exceed the protection limits of the 34450A.

**Note:** Voltages above 300 VAC may be measured only in circuits that are isolated from mains. However, transient overvoltages are also present on circuits that are isolated from mains. The 34450A is designed to safely withstand occasional transient overvoltages up to 2500 Vpk. Do not use this multimeter to measure circuits where transient overvoltages could exceed this level.

## Environmental Conditions

This instrument is designed for indoor use and in an area with low condensation. The table below shows the general environmental requirements for the instrument.

Environmental Condition	Requirement
Operating temperature	Full accuracy at 0 °C to 55 °C
Operating humidity	Full accuracy up to 80% RH at 30 °C (non-condensing)
Storage temperature	–40 °C to 70 °C
Altitude	Operating up to 3,000 meters
Pollution degree	Pollution Degree 2

### NOTE

The Agilent 34450A 5½ Digit Multimeter complies with the following EMC and safety requirements:

- IEC 61010-1:2001 / EN 61010-1:2001 (2nd Edition)
- IEC 61326-2-1:2005 / EN61326-2-1:2006
- CISPR 11:2003 / EN 55011:2007 Group 1 Class A
- Canada: ICES/NMB-001:Issue 4, June 2006
- Australia/New Zealand: AS/NZS CISPR 11:2004

### CAUTION

Degradation of some product specifications can occur in the presence of ambient electromagnetic (EM) fields and noise that are coupled to the power line or I/O cables of the instrument. The instrument will self-recover and operate to all specifications when the source of ambient EM field and noise are removed or when the instrument is protected from the ambient EM field or when the instrument cabling is shielded from the ambient EM noise.

## **Waste Electrical and Electronic Equipment (WEEE) Directive 2002/96/EC**

This instrument complies with the WEEE Directive (2002/96/EC) marking requirement. This affixed product label indicates that you must not discard this electrical/electronic product in domestic household waste.

### **Product Category:**

With reference to the equipment types in the WEEE directive Annex 1, this instrument is classified as a “Monitoring and Control Instrument” product.

The affixed product label is shown as below:



### **Do not dispose in domestic household waste**

To return this unwanted instrument, contact your nearest Agilent office, or visit [www.agilent.com/environment/product](http://www.agilent.com/environment/product) for more information.

## Additional Notices

The Agilent 34450A is provided with an Agilent 34138A Test Lead Set, described below.

### Test Lead Ratings

Test Leads - 1000 V, 15 A

Fine Tip Probe Attachments - 300 V, 3 A

Mini Grabber Attachment - 300 V, 3 A

SMT Grabber Attachments - 300 V, 3 A

### Operation

The Fine Tip, Mini Grabber, and SMT Grabber attachments plug onto the probe end of the Test Leads.

### Maintenance

If any portion of the Test Lead Set is worn or damaged, do not use. Replace with a new Agilent 34138A Test Lead Set.

## **WARNING**

**If the Test Lead Set is used in a manner not specified by Agilent Technologies, the protection provided by the Test Lead Set may be impaired. Also, do not use a damaged or worn Test Lead Set. Instrument damage or personal injury may result.**

---

## Declaration of Conformity (DoC)

The Declaration of Conformity (DoC) for this instrument is available on the Web site. You can search the DoC by its product model or description.

<http://regulations.corporate.agilent.com/DoC/search.htm>

### NOTE

If you are unable to search for the respective DoC, please contact your local Agilent representative.

---

## In This Guide...

This guide contains information to install the Agilent 34450A 5½ Digit Multimeter.

### **1 Getting Started Tutorial**

This chapter provides a quick tutorial showing you how to get started and use the front panel in order to make measurements.

### **2 Functions and Features**

This chapter contains information on the functions and features of the multimeter and how to use the front panel to operate these settings.

### **3 Measurement Tutorial**

The Agilent 34450A multimeter is capable of making very accurate measurements. In order to achieve the greatest degree of accuracy, you must take the necessary steps to eliminate potential measurement errors. This chapter describes the common errors found in measurements and gives suggestions on what you can do to avoid these errors.

### **4 Specifications**

This chapter describes the Agilent 34450A 5½ Digit Multimeter's specifications and operating specifications

**THIS PAGE HAS BEEN INTENTIONALLY LEFT BLANK.**

# Contents

**Figures** XVII

**Tables** XIX

<b>1</b>	<b>Getting Started Tutorial</b>	<b>1</b>
	The Front Panel at a Glance	2
	The display at a glance	3
	Single display screen	3
	Dual display screen	3
	The Keypad at a Glance	6
	Feature Upgrades	9
	The Rear Panel at a Glance	10
	Making Measurements	11
	Using the keys	11
	Digit masking	12
	Selecting current input terminals and measurement range	13
	Measuring AC (RMS) or DC voltage	13
	Measuring resistance	15
	Measuring AC (RMS) or DC current up to 100 mA	16
	Measuring AC (RMS) or DC current up to 10 A	17
	Measuring frequency for voltage	18
	Measuring frequency for current	19
	Testing continuity	20
	Checking diodes	21
	Measuring temperature	22
	Measuring capacitance	23

Selecting a Range	24
Remote Operation	25
USB interface	25
Serial interface	26
GPIB IEEE-488 (Optional)	27
Code compatibility mode	28
SCPI commands	28
<b>2 Functions and Features</b>	<b>31</b>
Math Operations	32
Null measurement	33
Hold measurement	35
Limit measurement	36
Accessing math menu	37
Editing single statistics	38
Editing all statistics	39
Editing dB measurement	40
Editing dBm measurement	41
Math annunciators	42
Editing math functions reference values	42
Editing values	43
The Dual Display	44
Using the dual display	45
Using the Utility Menu	47
RS232 utility sub-menu	51
GPIB Utility Sub-Menu	53
Reading error messages	54
The beeper	55
Storing and Recalling Instrument States	56
Reset/Power-On State	58
Triggering the Multimeter	60

Data Logging	65
Viewing the log info	69
Viewing the log list	70
Viewing the log histogram	71
Viewing the log statistics	72
Fluke 45/Fluke 8808A Code Compatibility Mode	73
Enabling the code compatibility function	73
Notes for Fluke 45/Fluke 8808A code compatibility mode	74
<b>3 Measurement Tutorial</b>	<b>75</b>
DC Measurement Considerations	76
Noise Rejection	77
Measurement Speed Consideration	80
Dual Measurement Considerations	81
DC voltage dynamic range in dual measurement	81
Voltage and current in dual measurement	82
Resistance Measurement Considerations	84
True RMS AC Measurements	87
Other Primary Measurement Functions	91
Frequency measurement errors	91
DC current measurements	92
Capacitance measurements	93
Temperature measurements	95
Other Sources of Measurement Error	96
<b>4 Specifications</b>	<b>99</b>
Test Considerations	100
DC Specifications	101
AC Specifications	103

## Contents

Temperature and Capacitance Specifications	105
Operating Specifications	106
Supplemental measurement specifications	108
General Characteristics	112
To calculate total measurement error	114
Accuracy specifications	115
Configuring for highest accuracy measurements	116

## Figures

Figure 1-1	34450A front panel	2
Figure 1-2	Typical single display screen	3
Figure 1-3	Typical dual display screen	3
Figure 1-4	34450A Keypad	6
Figure 1-5	Rear panel at a glance	10
Figure 1-6	ACV rms and DCV terminal connection and display	14
Figure 1-7	2-wire W terminal connection and display	15
Figure 1-8	4-wire W terminal connection and display	15
Figure 1-9	ACI rms or DCI (mA) terminal connection and display	16
Figure 1-10	ACI rms or DCI (A) terminal connection and display	17
Figure 1-11	Frequency terminal connection and display	18
Figure 1-12	Frequency terminal connection and display for ACI (mA)	19
Figure 1-13	Frequency terminal connection and display for ACI (A)	19
Figure 1-14	Continuity test terminal connection and display	20
Figure 1-15	Forward-biased diode terminal connection and display	21
Figure 1-16	Reverse-biased diode terminal connection and display	21
Figure 1-17	Temperature terminal connection and display	22
Figure 1-18	Capacitance terminal connection and display	23
Figure 1-19	Serial interface connector diagram	27
Figure 2-1	Accessing the null measurement	34
Figure 2-2	Accessing hold measurement	35
Figure 2-3	First page of the Utility menu	47
Figure 2-4	Second page of the Utility menu	47

## Figures

Figure 2-5 Trigger in connector	62
Figure 2-6 Trigger out connector	63
Figure 3-1 Common Mode Rejection (CMR)	77
Figure 3-2 Noise caused by ground loops	79
Figure 3-3 ADC Dynamic Range	82
Figure 3-4 Example of measuring voltage and current in dual measurement	83
Figure 3-5 Wiring resistance and current shunt resistance	92
Figure 3-6 Applying current to the capacitor	93

## Tables

Table 1-1	Display annunciators	4
Table 1-2	Keypad functions	6
Table 1-3	License details	9
Table 2-1	Math operations	32
Table 2-2	Math value annunciators	42
Table 2-3	Measurements available in dual display mode	44
Table 2-4	Measurement operation frequencies for DCV-ACI	45
Table 2-5	Utility menu available settings	48
Table 2-6	RS232 utility sub-menu	52
Table 2-7	Reset/Power-on state	58
Table 2-8	Data log menu options	67
Table 3-1	Common thermoelectric voltages for connections between dissimilar metals	76
Table 3-2	Examples of measurement ranges	84
Table 3-3	Typical errors for various pulse waveforms as a function of input pulse frequency	89
Table 4-1	DC accuracy $\pm$ (% of reading + % of range)	101
Table 4-2	AC accuracy $\pm$ (% of reading + % of range)	103
Table 4-3	Frequency accuracy $\pm$ (% of reading + count)	104
Table 4-4	Frequency resolution	104
Table 4-5	Temperature and capacitance accuracy $\pm$ (% of reading + % of range)	105
Table 4-6	Operating specifications on single display (approximate)	106
Table 4-7	Supplemental measurement specifications	108
Table 4-8	General characteristics	112

**THIS PAGE HAS BEEN INTENTIONALLY LEFT BLANK.**



# 1 Getting Started Tutorial

The Front Panel at a Glance	2
The Keypad at a Glance	6
The Rear Panel at a Glance	10
Feature Upgrades	9
Making Measurements	11
Selecting a Range	24
Remote Operation	25

This chapter provides a tutorial on how to get started using the Agilent 34450A 5½ Digit Multimeter and using the front panel in order to make measurements.



## The Front Panel at a Glance

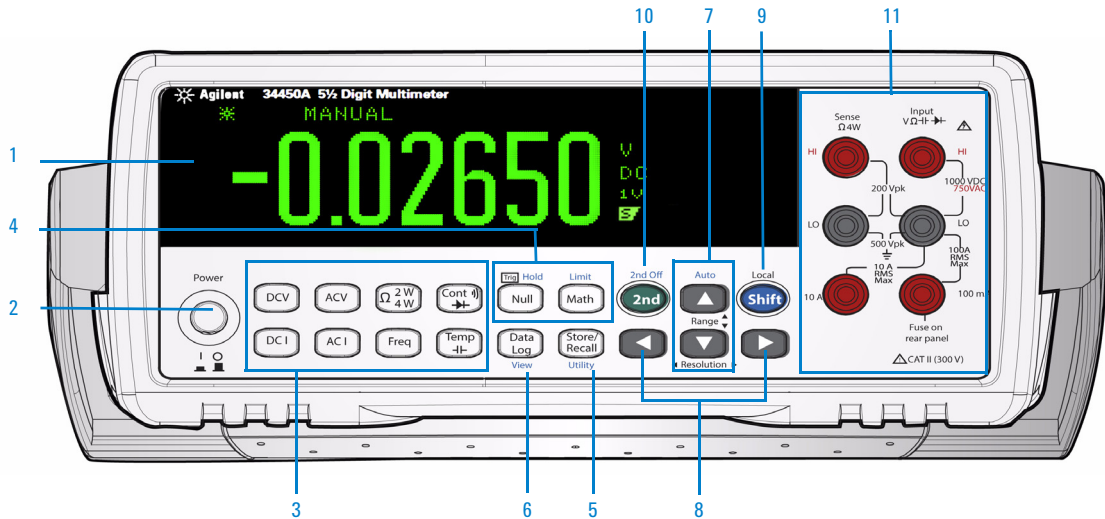

**Figure 1-1** 34450A front panel

- |  |  |
|--|--|
| <ul style="list-style-type: none"> <li><b>1</b> Display</li> <li><b>2</b> Power ON/OFF Switch</li> <li><b>3</b> Measurement functions</li> <li><b>4</b> Math Operations</li> <li><b>5</b> State Store/Recall, Utility Menu</li> <li><b>6</b> Data Log, View</li> </ul> | <ul style="list-style-type: none"> <li><b>7</b> Auto range and Manual range</li> <li><b>8</b> Resolution, Measurement Speed</li> <li><b>9</b> SHIFT (selects blue shifted keys) and Local Key</li> <li><b>10</b> Secondary Display Key</li> <li><b>11</b> Input Terminals</li> </ul> |
|--|--|

## The display at a glance

### Single display screen



Figure 1-2 Typical single display screen





















### Dual display screen







Figure 1-3 Typical dual display screen

The system annunciators are described in [Table 1-1](#).  
(See [Table 2-2](#) on page 42 for Math Annunciators).

**Table 1-1** Display annunciators

System Annunciator	Description
	Sample annunciator - indicates readings being taken
	The keypad has been locked. Press the  +  keys simultaneously for more than 3 seconds to unlock
	Fixed range is selected for primary function
	Auto-ranging is selected for primary function
	Data logging is in progress
	High input impedance is configured for DCV function
	2-wire resistance function is enabled
	4-wire resistance function is enabled
	Diode test function is enabled
	Capacitance function is enabled
	Continuity test function is enabled
	Error in queue
	Fast speed is selected
	Medium speed is selected
	Slow speed is selected
	Remote interface operation
	Code compatibility mode
	2nd key has been pressed
	Triggering has been enabled and the meter is in the “waiting-for-trigger” state

**Table 1-1** Display annunciators (continued)

System Annunciator	Description
	Shift key has been pressed
	Fixed range is selected for secondary function
	Auto-ranging is selected for secondary function
	Direct current
	Alternating current

## The Keypad at a Glance

The operation for each key is shown in [Table 1-2](#) below. Pressing a measurement function key changes the current key operation, brings up the relevant symbol on the display (see “[The display at a glance](#)” on page 3), and emits a beep.

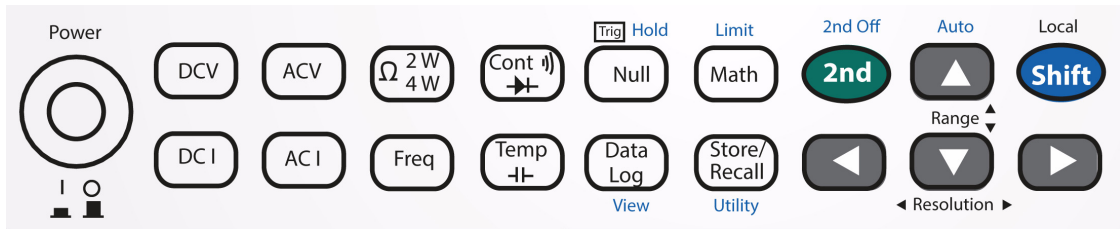

Figure 1-4 34450A Keypad

Table 1-2 Keypad functions





























Key	Description
<b>System-related operation</b>	
	Press to turn ON or turn OFF the 34450A multimeter
	Press to enable access to a button’s alternate function
	Press to enable the secondary display
	Press to disable secondary display
	<ul style="list-style-type: none"> <li>Press to adjust the measurement speed and resolution</li> <li>Press to navigate menus</li> </ul>

Table 1-2 Keypad functions (continued)

Key	Description
 	<ul style="list-style-type: none"> <li>• Press to adjust range</li> <li>• Press to adjust values</li> </ul>
 > 	Press to access utility menu. See <a href="#">“Using the Utility Menu”</a> on page 47
 + 	Press simultaneous for 3 seconds to lock and unlock the keypad
<b>Measurement functions</b>	
	Press to select DC voltage measurement
	Press to select AC voltage measurement
	Press to select DC current measurement
	Press to select AC current measurement
	Press to select between 2-wire or 4-wire resistance measurement
	Press to select frequency measurement
	Press to select between continuity or diode measurement
	Press to select between temperature or capacitance measurement

## 1 Getting Started Tutorial

**Table 1-2** Keypad functions (continued)

Key	Description
<b>Measurement - related functions</b>	
	Press to enable null function. See <a href="#">“Null measurement”</a> on page 33
	Press to access math functions menu. See <a href="#">“Math Operations”</a> on page 32
	Press to access data logging menu. See <a href="#">“Data Logging”</a> on page 65
	Press to access store/recall menu. See <a href="#">“Storing and Recalling Instrument States”</a> on page 56
 > 	Press to enable trigger/hold. See <a href="#">“Hold measurement”</a> on page 35
 > 	Press to access limit function. See <a href="#">“Limit measurement”</a> on page 36
 > 	Press to access data log view menu. See <a href="#">“”</a> on page 68

## Feature Upgrades

There are two licenses, listed in [Table 1-3](#), which are available for purchase:

**Table 1-3** License details

	<b>Default Factory Settings</b>	<b>With Purchase of License</b>	<b>Part Number</b>
Data Logging Memory	5,000 readings	50,000 readings (Option 3445MEMU)	34450A-801
GPIB Remote Operation	Disabled	Enabled (Option 3445GPBU)	34450A-800

For the license upgrade procedure, refer to the instructions in the license redemption e-mail.

## The Rear Panel at a Glance

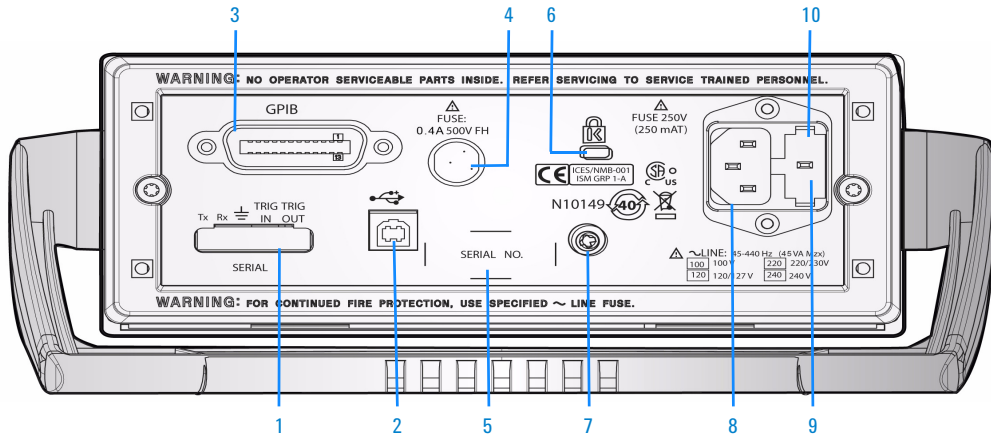

**Figure 1-5** Rear panel at a glance

- 1 Serial Interface Connector
- 2 USB Interface Connector
- 3 GPIB with Option 3445GPBU installed
- 4 Current Fuse
- 5 Model and Serial Number Label
- 6 Kensington Lock
- 7 Chassis Ground Lug
- 8 AC Power Connector
- 9 AC Line Fuse
- 10 AC Line Voltage Selector

## Making Measurements

The following pages show how to make measurement connections and how to select measurement functions from the front panel for each of the measurement functions.

For remote operation, refer to the MEASure Subsystem in the *Agilent 34450A Online Programmer's Reference* Helpfile.

### Using the keys

The meter functions and operations can be selected by pressing the buttons located on the front panel; see “[The Keypad at a Glance](#)” on page 6. There are different ways in which the buttons are used to select the functions and operations. The ways to use the buttons are shown below:

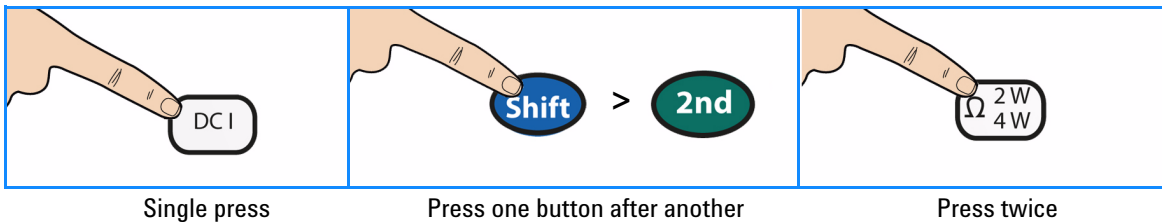

## Digit masking

The navigation keypad provides a shortcut to mask (change the number of digits displayed) the reading on the main display, easing readability. Masking digits only affects what is displayed. It does not affect measurement speed or accuracy. It applies to all functions except continuity, diode test, temperature, and capacitance measurement. To enable masking, follow the instructions below:

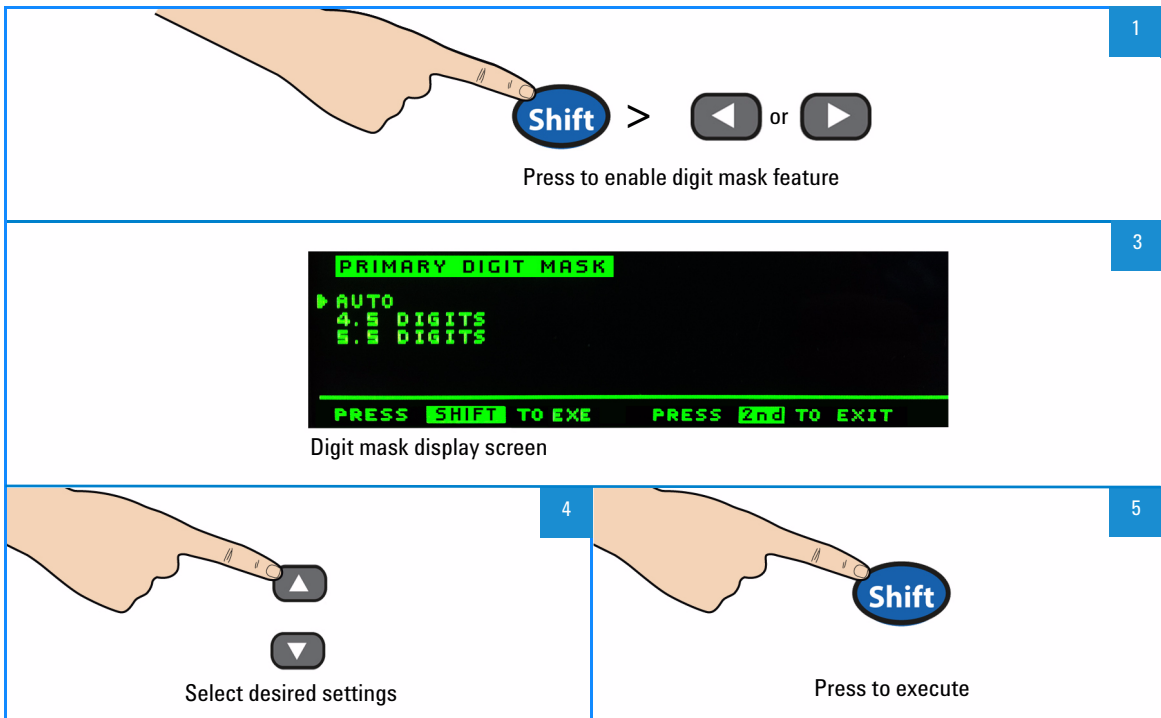

## Selecting current input terminals and measurement range

If AC or DC current is being measured in auto-ranging mode, with a signal input at 100 mA, the meter will select the range 100  $\mu$ A to 100 mA automatically.

If a signal input is applied to the 10 A input terminal, the meter will select the 1 A to 10 A range automatically.

## Measuring AC (RMS) or DC voltage

### AC Voltage:

- **Measurement Range:** 100.000 mV, 1.00000 V, 10.0000 V, 100.000 V, 750.00 V
- **Speed:** Slow-2 Hz, Medium-20 Hz, Fast-200 Hz
- **Default Setting:** Autoranging, Slow measurement speed
- **Measurement Method:** AC coupled true RMS - measures the AC component with up to 400 VDC bias on any range
- **Crest Factor:** Maximum 3:1 at full scale
- **Input Impedance:** 1 M $\Omega$   $\pm$  2% in parallel with <100 pF on all ranges
- **Input Protection:** 750 V rms on all ranges (HI terminal)

### DC Voltage:

- **Measurement Range:** 100.000 mV, 1.00000 V, 10.0000 V, 100.000 V, 1000.00 V
- **Speed:** Slow, Medium, Fast
- **Default Setting:** Autoranging, Slow measurement speed
- **Measurement Method:** Sigma Delta A-to-D converter
- **Input Impedance:** >10 G $\Omega$  selected range (0.1 V and 1 V only) or ~10 M $\Omega$  all ranges (typical)
- **Input Protection:** 1000 V on all ranges (HI terminal)

## 1 Getting Started Tutorial

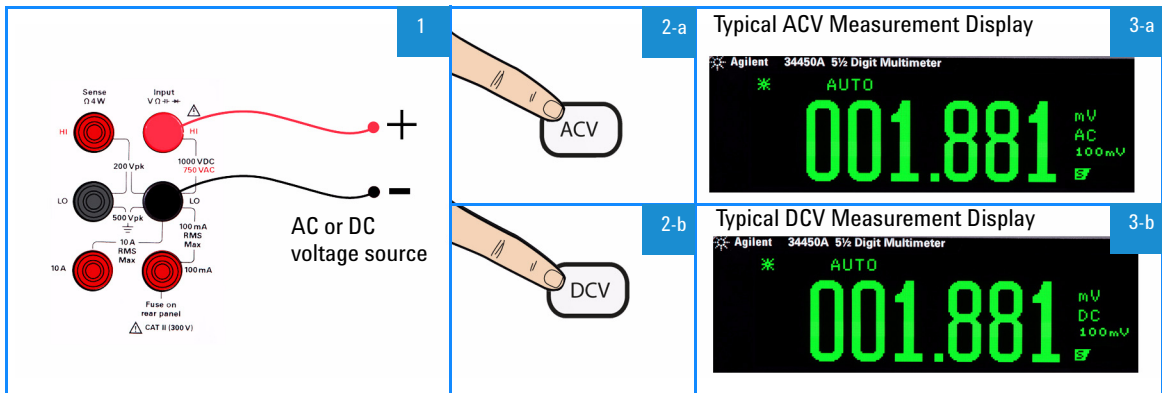

Figure 1-6 ACV rms and DCV terminal connection and display

### WARNING

Do not apply any voltage to the instrument inputs until all terminals are properly connected. Plugging or unplugging the test lead while high voltage is applied can cause instrument damage, and may increase the risk of electric shock.

## Measuring resistance

- **Measurement Range:** 100.000  $\Omega$ , 1.00000 k $\Omega$ , 10.0000 k $\Omega$ , 100.000 k $\Omega$ , 1.00000 M $\Omega$ , 10.0000 M $\Omega$ , 100.000 M $\Omega$ .
- **Speed:** Slow, Medium, Fast
- **Default Setting:** Autoranging, Slow measurement speed
- **Measurement Method:** 2-wire ohms or 4-wire ohms
- **Input protection:** 1000 V on all ranges (HI terminal)

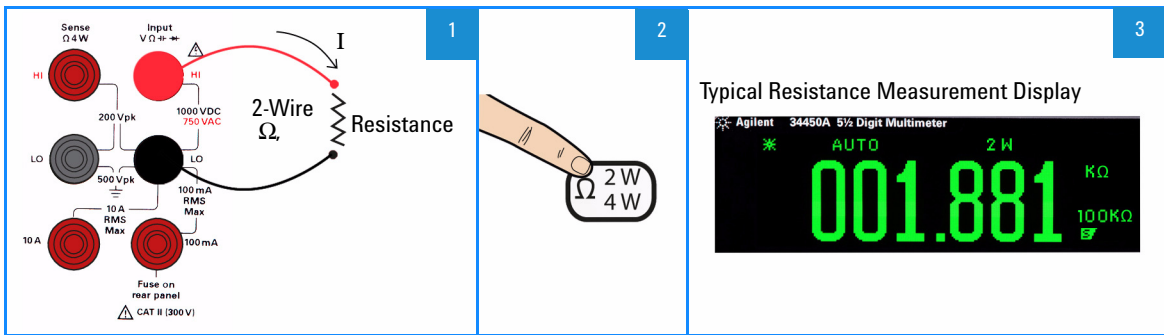

Figure 1-7 2-wire  $\Omega$  terminal connection and display

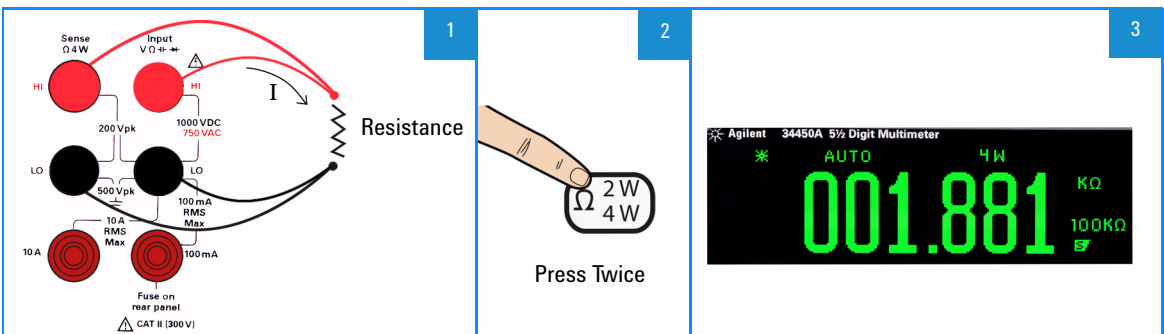

Figure 1-8 4-wire  $\Omega$  terminal connection and display

## Measuring AC (RMS) or DC current up to 100 mA

- **Measurement Range (AC):** 10.0000 mA, 100.000 mA
- **Measurement Range (DC):** 100.000  $\mu$ A, 1.00000 mA, 10.0000 mA, 100.000 mA
- **Speed (AC):** Slow-2 Hz, Medium-20 Hz, Fast-200 Hz
- **Speed (DC):** Slow, Medium, Fast
- **Default Setting:** Autoranging, Slow measurement speed
- **Shunt Resistance:** 1  $\Omega$  for 10 mA and 100 mA, and 90  $\Omega$  for 100  $\mu$ A to 1 mA ranges
- **Input Protection:** Rear Panel 0.4 A, 500 V FH fuse for the I terminal

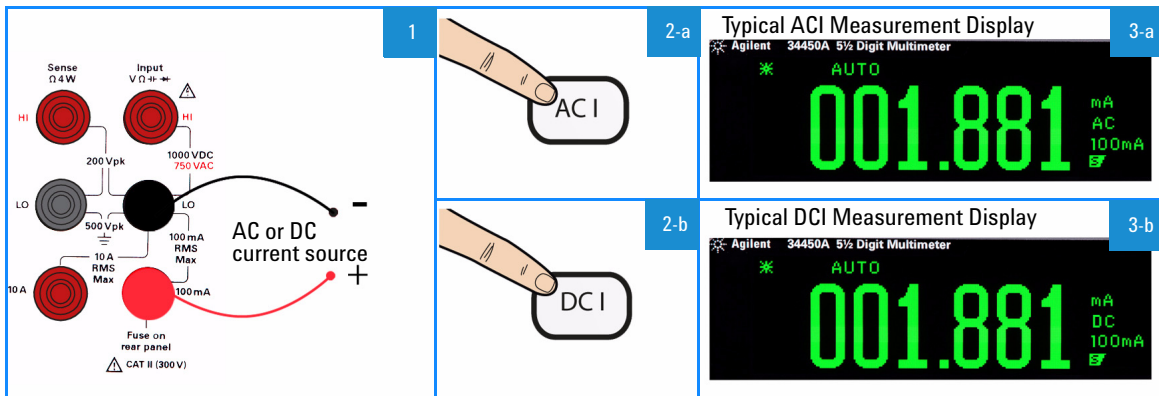

Figure 1-9 ACI rms or DCI (mA) terminal connection and display

## Measuring AC (RMS) or DC current up to 10 A

- **Measurement Range (AC):** 1.00000 A, 10.0000 A
- **Measurement Range (DC):** 1.00000 A, 10.0000 A
- **Speed (AC):** Slow-2 Hz, Medium-20 Hz, Fast-200 Hz
- **Speed (DC):** Slow, Medium, Fast
- **Default Setting:** Autoranging, Slow measurement speed
- **Shunt Resistance:** 0.01  $\Omega$  for 1 A and 10 A range
- **Input Protection:** Internal 11 A, 1000 V fuse for the 10 A terminal

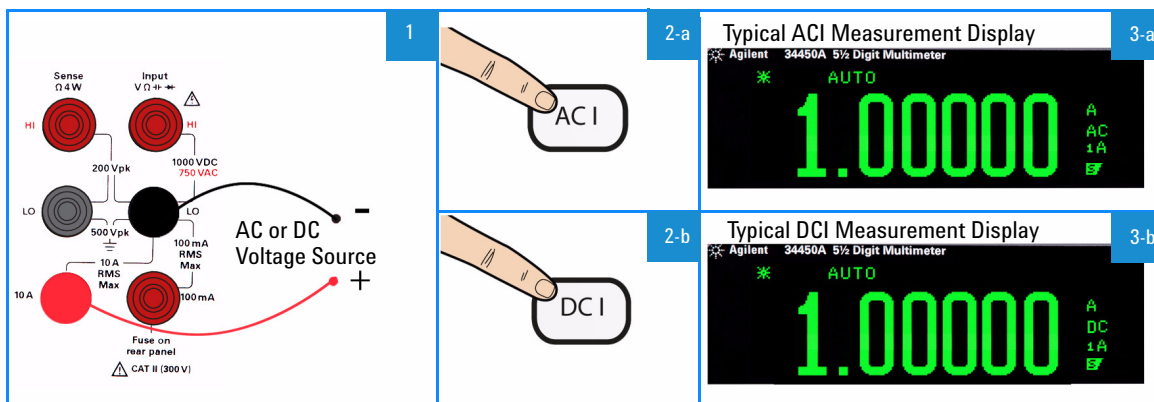

Figure 1-10 ACI rms or DCI (A) terminal connection and display

## Measuring frequency for voltage

- **Measurement Range:** 100.000 mV, 1.00000 V, 10.0000 V, 100.000 V, 750.00 V. Range is based on the voltage level of the signal, not frequency.
- **Speed:** Slow, Medium
- **Measurement Method:** Reciprocal counting technique
- **Signal level:** 10% of range to full scale input on all ranges except where noted. 100 mV range specifications are for full scale or greater inputs. For inputs from 10 mV to 100 mV, multiply the total % of reading error by 10.
- **Gate Time:** 1 second (slow mode) or 0.1 second (medium mode)
- **Input Protection:** 750 V rms on all ranges (HI terminal)

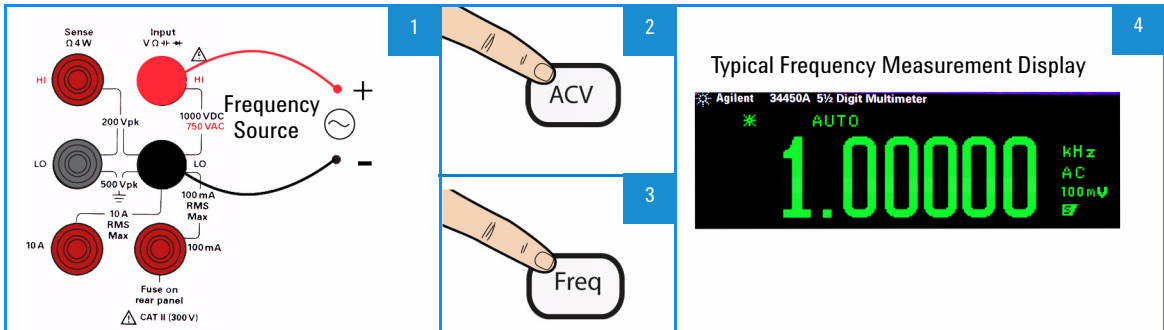

Figure 1-11 Frequency terminal connection and display

## Measuring frequency for current

- **Measurement Range:** 10.0000 mA, 100.000 mA, 1.00000 A, 10.0000 A. Range is based on the current level of the signal, not frequency.
- **Speed:** Slow, Medium
- **Measurement Method:** Reciprocal counting technique
- **Signal level:** 10% of range to full scale input on all ranges except where noted. 10 mA range specifications are for full scale or greater inputs. For inputs from 1 mA to 10 mA, multiply the total % of reading error by 10.
- **Gate Time:** 1 second (slow mode) or 0.1 second (medium mode)
- **Input Protection:** 750 V rms on all ranges (HI terminal)

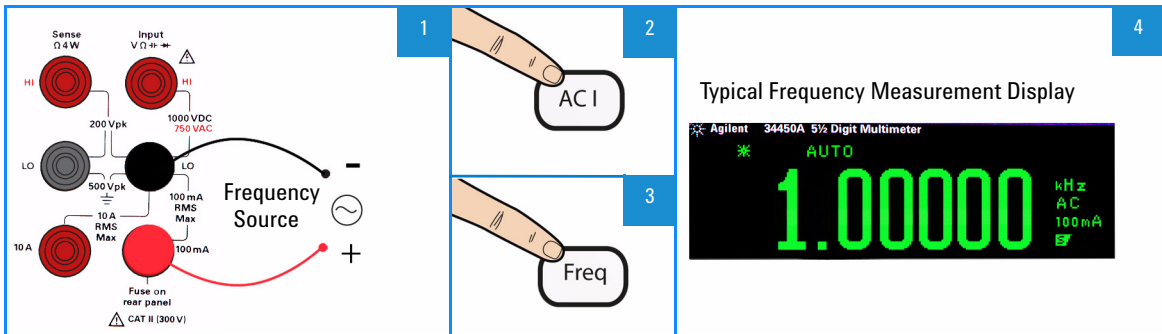

Figure 1-12 Frequency terminal connection and display for ACI (mA)

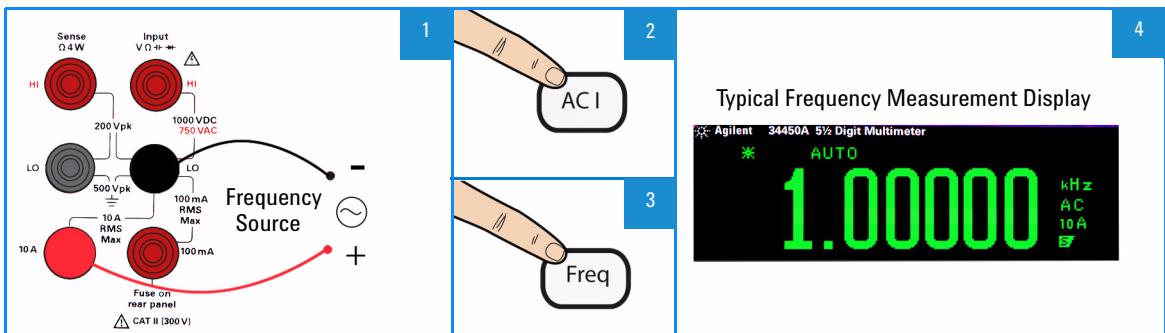

Figure 1-13 Frequency terminal connection and display for ACI (A)

## Testing continuity

- **Measurement Method:** 0.5 mA  $\pm$  0.2% constant current source
- **Response Time:** 165 samples/second with audible tone
- **Continuity Threshold:** 10  $\Omega$  fixed
- **Input Protection:** 1000 V (HI terminal)

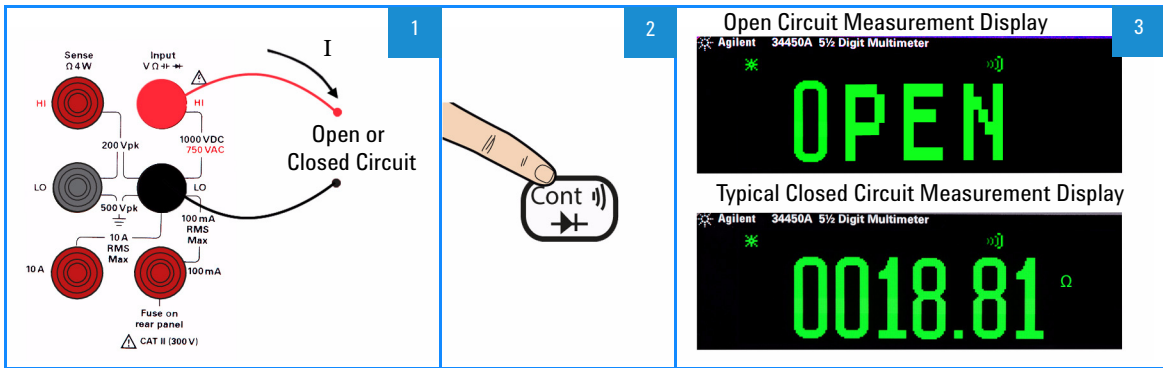

Figure 1-14 Continuity test terminal connection and display

## Checking diodes

- **Measurement Method:** Uses  $0.5\text{ mA} \pm 0.2\%$  constant current source
- **Response Time:** 190 samples/ second with audible tone
- **Input Protection:** 1000 V (HI terminal)

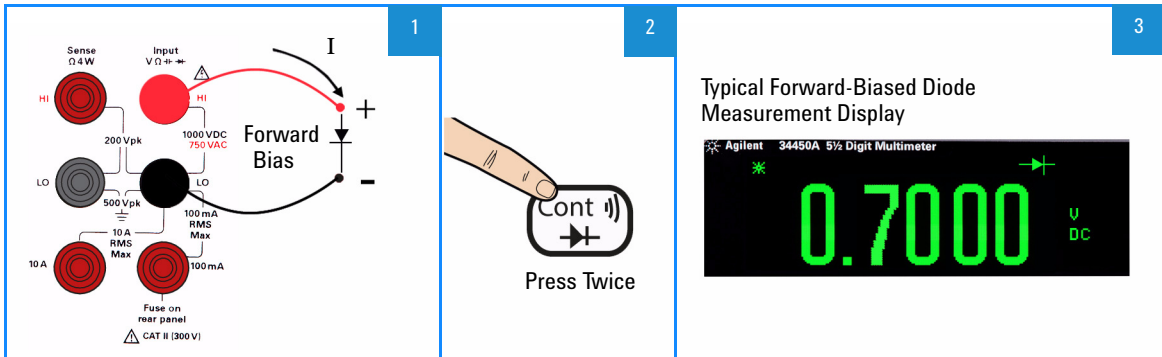

Figure 1-15 Forward-biased diode terminal connection and display

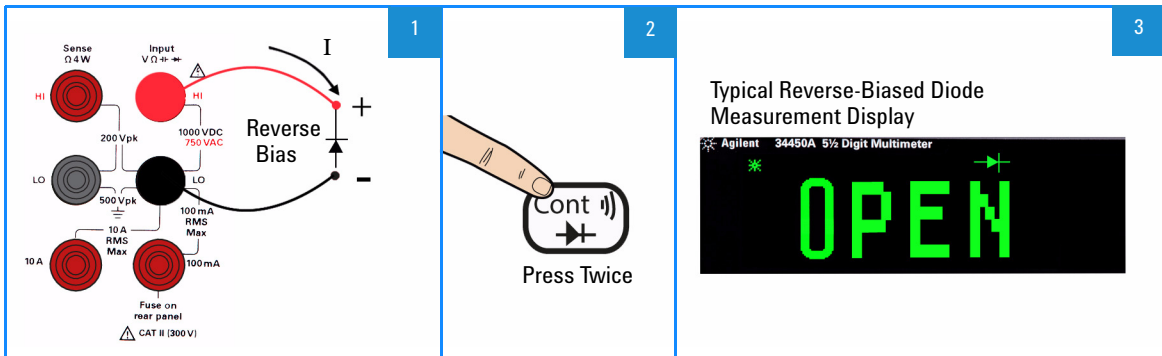

Figure 1-16 Reverse-biased diode terminal connection and display

## Measuring temperature

- **Measurement Range:**  $-80.0\text{ }^{\circ}\text{C}$  to  $150.0\text{ }^{\circ}\text{C}$ ,  $-110.0\text{ }^{\circ}\text{F}$  to  $300.0\text{ }^{\circ}\text{F}$
- **Measurement Method:** 2-wire Ohms measurement of  $5\text{ k}\Omega$  thermistor sensor (E2308A) with computed conversion
- **Input Protection:** 1000 V (HI terminal)
- **Optional Accessory:** E2308A Thermistor temperature probe

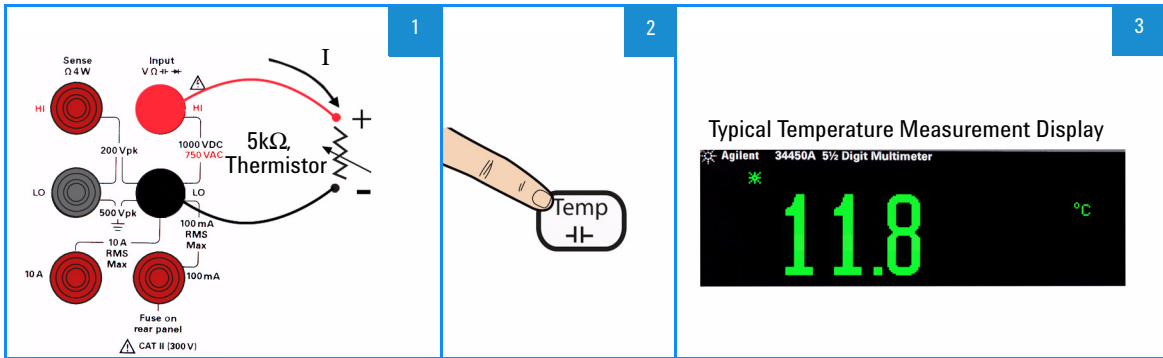

Figure 1-17 Temperature terminal connection and display

## Measuring capacitance

- **Measurement Range:** 1.000 nF, 10.00 nF, 100.0 nF, 1.000  $\mu$ F, 10.00  $\mu$ F, 100.0  $\mu$ F, 1.000 mF, 10.00 mF
- **Default Setting:** Autoranging
- **Measurement Method:** Computed from constant current source charge time.  
Typical 0.12 V to 1.0 V AC signal level
- **Input Protection:** 1000 V (HI terminal)

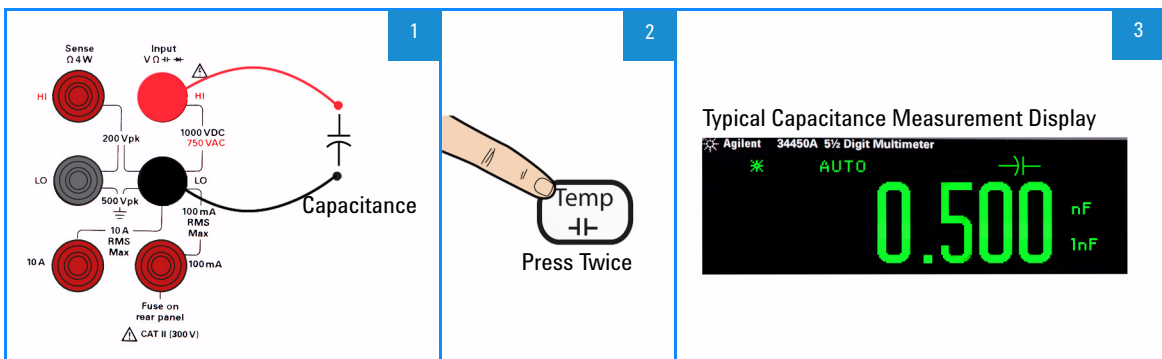











Figure 1-18 Capacitance terminal connection and display

## Selecting a Range

You can let the multimeter automatically select the range using autoranging, or you can select a fixed range using manual ranging. Autoranging is convenient because the multimeter automatically selects the appropriate range for sensing and displaying each measurement. However, manual ranging results in better performance, since the multimeter does not have to determine which range to use for each measurement.

 <p>Autoranging enabled</p>	<p>1  2</p> <p></p> <p>Press to disable autoranging</p>
 <p>Manual ranging enabled</p>	<p>3  4</p> <p></p> <p>Selects an upper range</p> <p>Selects a lower range</p>
 <p>Manual ranging enabled</p>	<p>5  &gt;  6</p> <p>Press to enable autoranging and disable manual ranging</p>

# Remote Operation

## USB interface

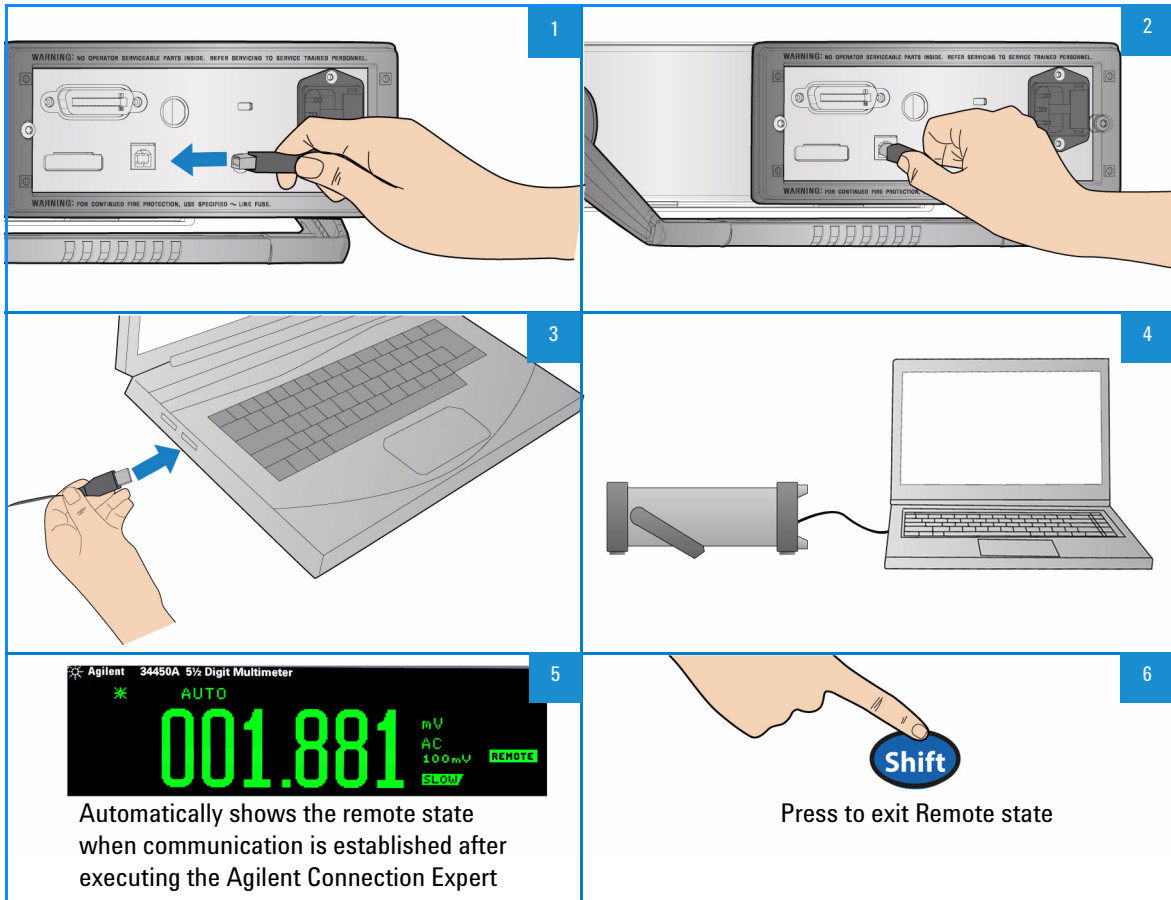

### NOTE

To easily configure and verify an interface connection between the 34450A and your PC, use the Automation-Ready CD, which is shipped with your 34450A. This CD includes the *Agilent IO Libraries Suite* and the *Agilent Connection Expert* application. For more information about Agilent's I/O connectivity software, visit [www.agilent.com/find/iolib](http://www.agilent.com/find/iolib).

---

## Serial interface

### NOTE

To use this serial interface, it is recommended to use the optional Serial-to-RS232 adapter (34450A-700)

---

The 5-pin male connector on the meter's rear panel is a serial port or terminal to form a minimal 3-wire RS-232 connection (TX, RX, GND).

In order to operate the multimeter via a host computer or terminal, the parameters of the serial interface within the multimeter has to match the parameters with the serial interface provided by the host or terminal.

The default settings of the meter are 9600 baud rate, non-parity, 8 data bits, and 1 stop bit (9600, n, 8, 1).

The connecting diagram and setup procedure are shown in “Serial interface connector diagram” and “RS232 utility sub-menu” on page 52 below.

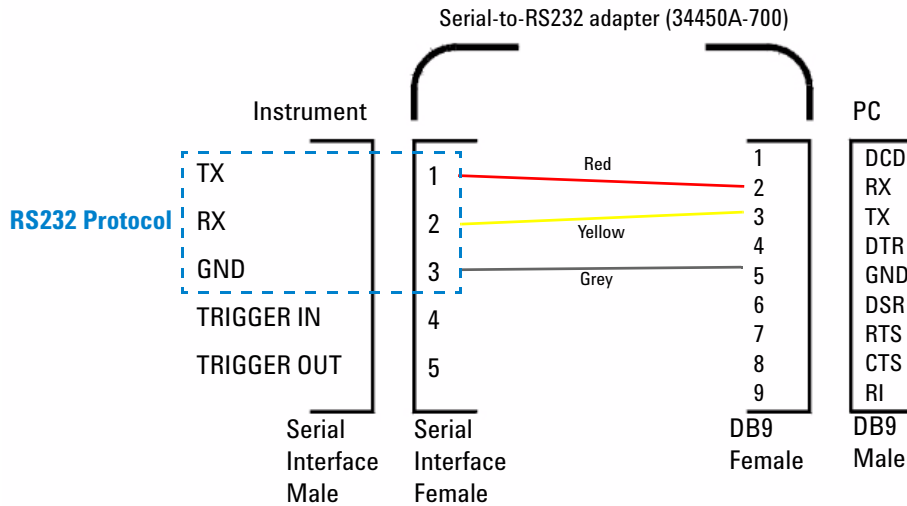

**Figure 1-19** Serial interface connector diagram

## GPIB IEEE-488 (Optional)

The GPIB interface is a bus structure that links the multimeter to a host computer or other GPIB controlled instruments to form an automated measuring system.

It can be used to connect up to 15 devices on one continuous bus, star, or linear bus network.

In order to operate the meter via a host computer or terminal, the parameters in the GPIB interface within the meter has to match the parameters in the GPIB interface provided by the host or terminal.

The default factory settings are address 22.

## Code compatibility mode

The 34450A includes a code compatibility mode. This mode saves time and effort by eliminating the need to re-write programs using the 34450A SCPI command.

## SCPI commands

The Agilent 34450A complies with the syntax rules and conventions of SCPI (*Standard Commands for Programmable Instruments*).

### NOTE

For a *complete* discussion of the 34450A SCPI syntax, refer to the *Agilent 34450A Programmer's Reference Helpfile*. This is provided in the *34450A Product Reference CD-ROM*

---

### SCPI Language Version

You can determine the multimeter's SCPI language version by sending the `SYSTem:VERSion?` command from the remote interface.

- You can query the SCPI version from the remote interface only.
- The SCPI version is returned in the form “YYYY.V”, where “YYYY” represents the year of the version, and “V” represents a version number for that year (for example, 1994.0).

## **1 Getting Started Tutorial**



## 2 Functions and Features

Math Operations	32
The Dual Display	44
Using the Utility Menu	47
Storing and Recalling Instrument States	56
Reset/Power-On State	58
Triggering the Multimeter	60
Data Logging	65

This chapter contains information on the functions and features of the Agilent 34450A 5½ Digit Multimeter and how to use the front panel to operate these settings.



# Math Operations

Table 2-1 below describes the math operations that can be used with each measurement function.

**Table 2-1** Math operations

Math Function	Measurement Function									
	DCV	ACV	DCI	ACI	$\Omega$	FREQ	DIODE	CONT	TEMP	CAP
Null	✓	✓	✓	✓	✓	✓	-	-	✓	✓
Limit	✓	✓	✓	✓	✓	✓	-	-	✓	✓
Hold	✓	✓	✓	✓	✓	✓	-	-	✓	✓
dB	✓	✓	-	-	-	-	-	-	-	-
dBm	✓	✓	-	-	-	-	-	-	-	-
Stats	✓	✓	✓	✓	✓	✓	-	-	✓	✓

- Only one math operation can be turned-on at a time.
- Math operation does not support external triggering.
- Hold operation does not support fast mode.
- In the dual display mode, selecting the math operation will apply to the primary measurement function and turn off the secondary function.
- Range and resolution changing is allowed for all math operations.
- The reference/offset/limit values used for the Null, Limit, dB, and dBm math functions are editable.
- For remote operation, refer to the CALCulate Subsystem in the *Agilent 34450A Programmer's Reference* Helpfile.

## Null measurement

When making null measurements, also called relative measurement, each reading is the difference between a stored null value and the input signal.

For example, this feature can be used to make more accurate resistance measurements by nulling the test lead resistance.

Before performing null measurement, eliminate offset errors associated with test lead resistance by following the steps below:

<div data-bbox="184 741 668 916" data-label="Image"> </div>	<div data-bbox="706 685 721 711" data-label="Text"> <p>1</p> </div> <div data-bbox="743 685 1113 986" data-label="Image"> </div> <div data-bbox="1220 685 1235 711" data-label="Text"> <p>2</p> </div>
<div data-bbox="152 991 414 1145" data-label="Image"> </div> <div data-bbox="172 1159 531 1189" data-label="Text"> <p>Press to enable null measurement</p> </div>	<div data-bbox="521 998 535 1024" data-label="Text"> <p>3</p> </div> <div data-bbox="601 1008 1175 1168" data-label="Image"> </div> <div data-bbox="1220 998 1235 1024" data-label="Text"> <p>4</p> </div>
<div data-bbox="152 1234 478 1477" data-label="Image"> </div>	<div data-bbox="521 1241 535 1267" data-label="Text"> <p>5</p> </div> <div data-bbox="601 1251 1175 1411" data-label="Image"> </div> <div data-bbox="1220 1241 1235 1267" data-label="Text"> <p>6</p> </div>

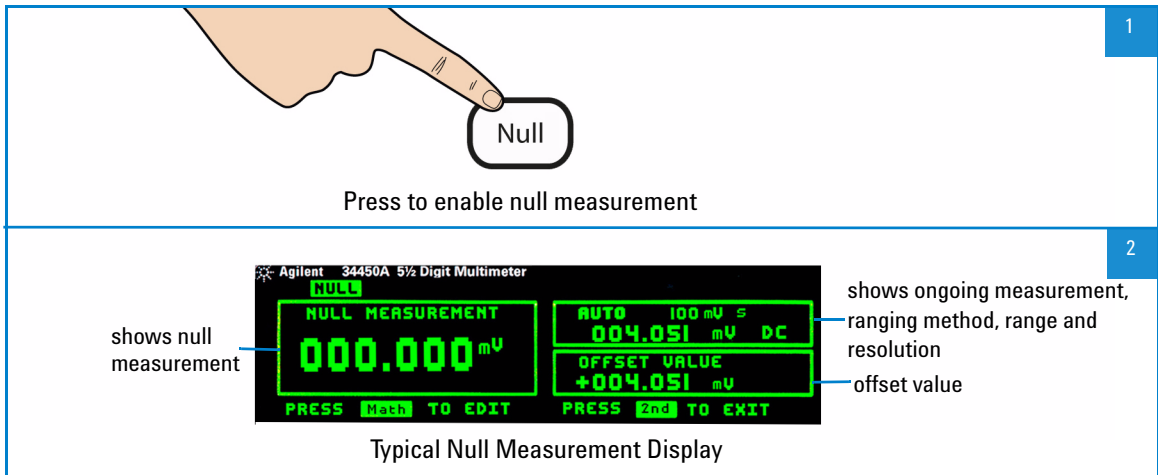

**Figure 2-1** Accessing the null measurement

After you enable the null operation, the multimeter stores the next reading into the offset register and immediately displays the null measurement:

$$\text{Null measurement display} = \text{Reading} - \text{Offset}$$

You can view and edit the offset value in the secondary display as described in [“Editing math functions reference values”](#) on page 42.

## Hold measurement

The hold feature allows you to capture and hold a stable reading on the front panel display.

When a stable reading is detected, the multimeter emits a beep (if the buzzer is enabled in the utility menu) and holds the reading on the primary display.

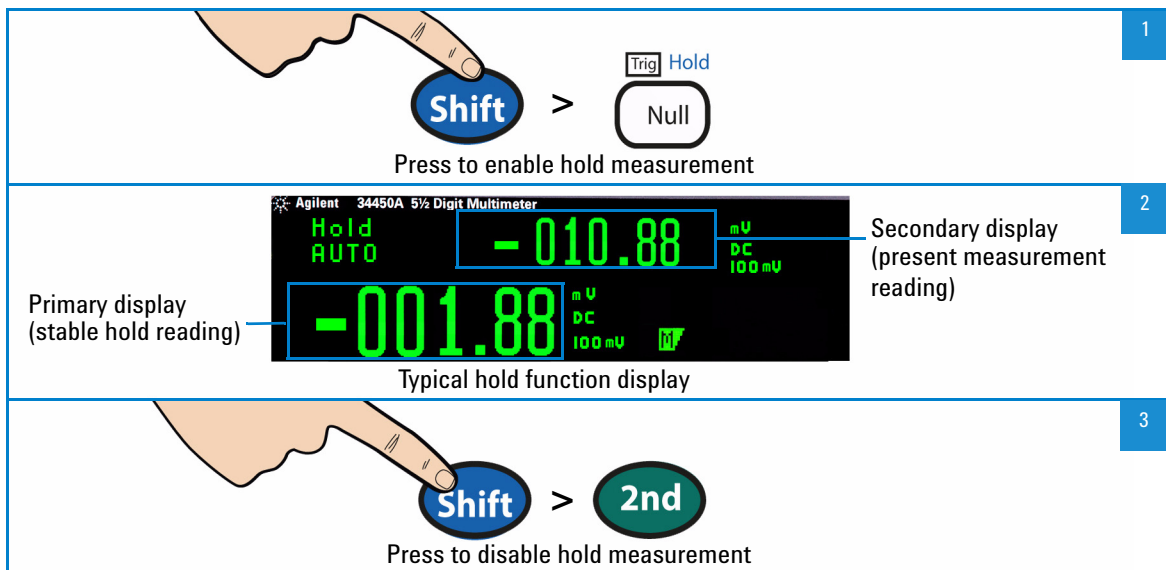

**Figure 2-2** Accessing hold measurement

When enabled, the hold operation turns on the hold annunciator and begins evaluating readings using the rules described below:

**Primary Display = Reading<sub>N</sub> IF Max() – Min() ≤ 0.1% × Reading<sub>N</sub>**











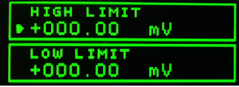

The decision to update a new reading value in the primary display is based upon the box-car moving statistics of the present reading and the three previous readings :

**Max (Reading<sub>N</sub> Reading<sub>N-1</sub> Reading<sub>N-2</sub> Reading<sub>N-3</sub>)**

**Min (Reading<sub>N</sub> Reading<sub>N-1</sub> Reading<sub>N-2</sub> Reading<sub>N-3</sub>)**

## Limit measurement

The limit operation allows you to perform pass/fail testing against specified upper and lower limits.

 <p>Shift &gt; Limit Math</p>	<p>1</p> <p>Press to enable limit measurements</p>
<p>The upper limit must always be greater than the lower limit. Otherwise, "INVALID LIMIT" will be shown.</p>	 <p>2</p> <p>Shows present measurement</p> <p>Limit state</p> <p>Typical limit function display</p>
 <p>3</p> <p>Limit Math</p> <p>Press to edit</p>	<p>4</p>   <p>Choose the limit mode that you want to change</p>
 <p>5</p> <p>Limit Math</p> <p>Press to edit</p>	<p>6-a</p>   <p>Increase/decrease the respective digit</p> <p>6-b</p>   <p>Select the editable digit to the left or right</p>
 <p>7</p> <p>Limit Math</p> <p>Press to save</p>	<p>8</p>  <p>Press to exit the limit operation or edit mode</p>

## Accessing math menu

The math operation can be enabled using the following steps:

1

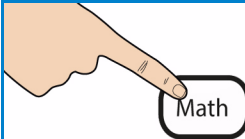

Press to display math menu

2



Math menu display

## Editing single statistics

The single statistics can be edited using the following steps:

1
2



Select STATS (SINGLE) option

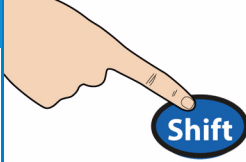

Press to start

---

3



Present measurement

Typical statistics (single) display for Max reading

Statistical values

---

4
5
6

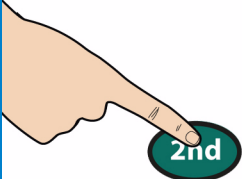

Press to edit



Press to toggle the Max/Min/Avg/N values



- Max Maximum reading
- Min Minimum reading
- Avg Average of all readings
- N Number of readings taken

---

7



Press to exit

**Note:** Each time a new min or max value is stored, the multimeter will beep once (if the buzzer is turned on in the utility menu) and the Min or Max annunciator is briefly turned on for 1 second beside the secondary display.

## Editing all statistics

The all statistics in the math operation can be edited using the following steps:

Agilent 34450A 5½ Digit Multimeter  
**MATH**  
 STATS (SINGLE)  
 ▶ **STATS (ALL)**  
 dB  
 dB<sub>m</sub>  
 -----  
 PRESS **Shift** TO START PRESS **2nd** TO EXIT

Select STATS (ALL)

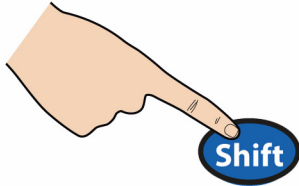

**Shift**

Press to start

---

STATS N= 34  
 -----  
 AUTO 100mV S      MAX  
 004.037 mV DC      004.058 mV  
 -----  
 AVG                      MIN  
 004.032 mV          004.011 mV  
 -----  
 PRESS **2nd** TO EXIT

Number of readings taken

Present measurement

Average reading

Maximum reading

Minimum reading

3

---

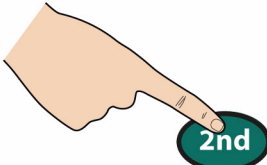

**2nd**

Press to exit

4

**Note:** Each time a new min or max value is stored, the multimeter will beep once (if the buzzer is turned on in the utility menu) and the New annunciator is briefly turned on for 1 second in the respective Min or Max box

34450A User's Guide

39

## Editing dB measurement

When enabled, the dB operation computes the dBm value for the next reading, stores the dBm result into the dB Ref register, and immediately produces the following calculation. The first displayed reading is always precisely 000.00 dB.

$$dB = 10 \times \text{Log}_{10} [(Reading^2/R_{REF})/0.001 W] - dB \text{ Ref}$$



Select dB option

1

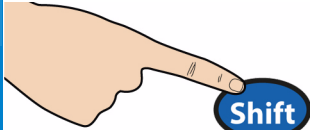

2

Press to edit

---

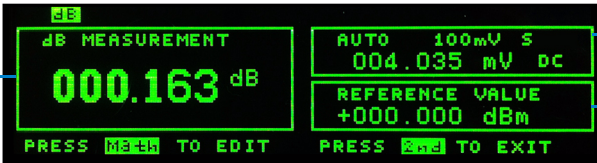

dB measurement

3

Ongoing measurement

Reference value  
0dB to ±120.000 dBm  
Default : R<sub>REF</sub> is 0 dBm

---

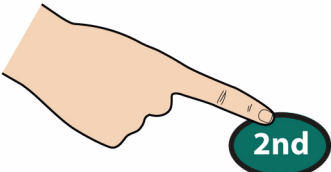

4

Press to exit

You can view and edit the dB reference value as described in “Editing math functions reference values” on page 42.

## Editing dBm measurement

The logarithmic dBm (decibels relative to one milliwatt) scale is often used in RF signal measurements. The multimeter's dBm operation takes a measurement and calculates the power delivered to a reference resistance (typically 50, 75, or 600 Ω). The formula used for conversion from the voltage reading is:

$$dBm = 10 \times \text{Log}_{10} [(\text{Reading}^2 / R_{REF}) / 0.001 \Omega ]$$

You can choose from several reference resistance values:

$R_{REF} = 2 \Omega, 4 \Omega, 8 \Omega, 16 \Omega, 50 \Omega, 75 \Omega, 93 \Omega, 110 \Omega, 124 \Omega, 125 \Omega, 135 \Omega, 150 \Omega, 250 \Omega, 300 \Omega, 500 \Omega, 600 \Omega, 800 \Omega, 900 \Omega, 1000 \Omega, 1200 \Omega, \text{ or } 8000 \Omega$

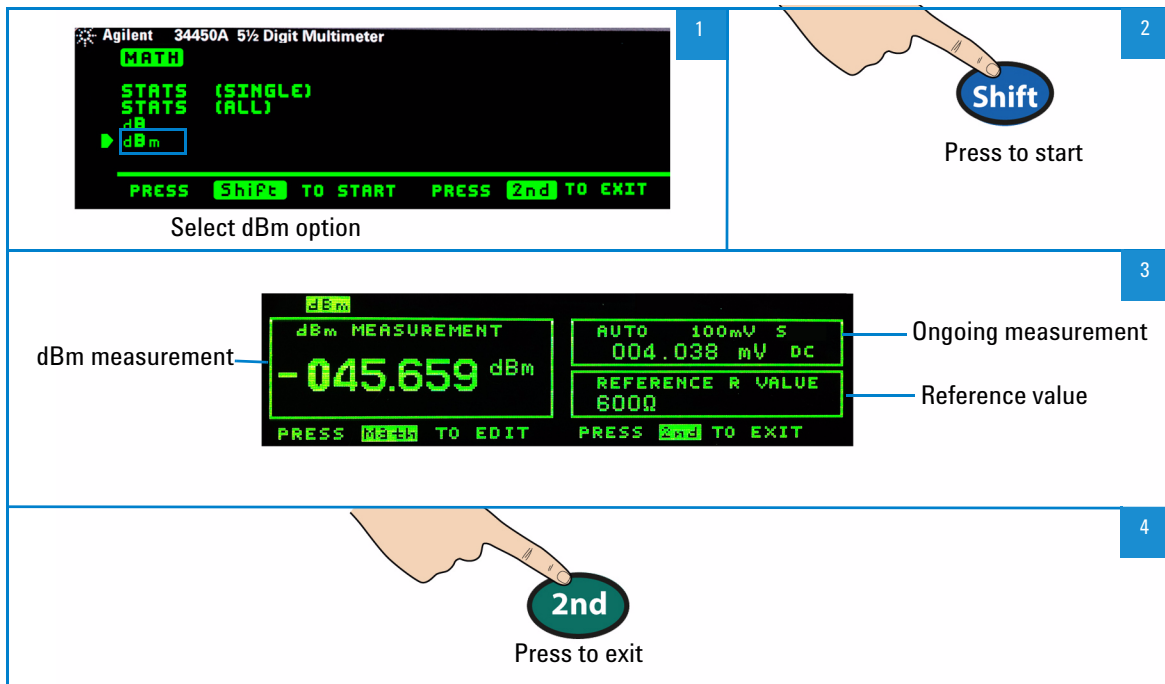

You can view and select the reference value as described in “Editing math functions reference values” on page 42.

## Math annunciators

Table 2-2 below shows the possible math annunciators which can appear on the display and the editable values.

**Table 2-2** Math value annunciators

Math Operation	When Viewing/Editing	Editable	Math Annunciator
Null	Offset	✓	Offset Value
dBm	R <sub>REF</sub>	✓	Reference R Value
dB	dB Ref	✓	Reference Value
Statistics	Maximum	-	Max
	Minimum	-	Min
	Average	-	Avg
	Reading Count	-	N
Limit	HI Limit	✓	High Limit
	LO Limit	✓	Low Limit

## Editing math functions reference values



The reference values used for the Null, Limit, dB, or dBm math functions, can be edited when you enable the stated function (refer to Table 2-2 on page 42 for a list).

For remote operation, refer to the CALCulate Subsystem in the *Agilent 34450A Programmer's Reference Helpfile*.

## Editing values

For math functions with editable values, the label “**PRESS MATH TO EDIT**” will be shown at the bottom left of the display.

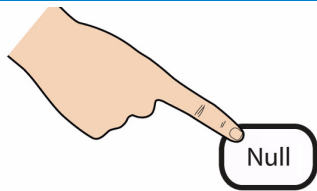
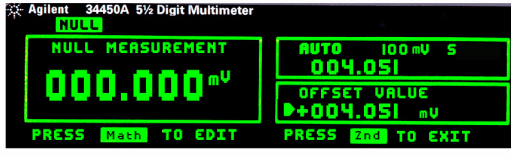
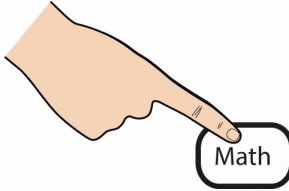
To edit math values, follow the steps below:

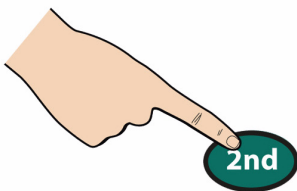
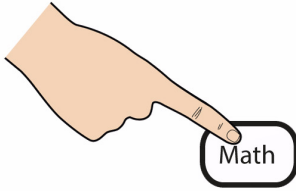
<p>1</p>  <p>Press to display null menu</p>	<p>2</p> 
<p>3</p>  <p>Press to edit</p>	<p>4-a</p>  <p>Press for digit selection</p> <p>4-b</p>  <p>Press to change the value of selected digit</p>
<p>5-a</p>  <p>Press to exit without save</p>	<p>5-b</p>  <p>Press to save the reference value</p>

## The Dual Display

Most measurement functions have predefined range or measurement capabilities that can be displayed in the dual measurement mode. All math operations have predefined operations that are displayed on the dual display.

[Table 2-3](#) below shows the measurement functions which are available in dual display mode.

**Table 2-3** Measurements available in dual display mode<sup>[1][2][3][4][5]</sup>

Primary Display	Secondary Display				
	DCV	ACV	DCI	ACI	Frequency
DCV	-	✓	✓	✓	-
ACV	✓	-	✓	✓	✓
DCI	✓	✓	-	-	-
ACI	✓	✓	-	-	✓
FREQUENCY	-	✓	-	✓	-

[1] All specifications are ensured only under a single display.

[2] For ACI-ACV dual measurement, the ACV input signal is limited to 500,000 V×Hz.

[3] For DCI-ACV dual measurement, the ACV input signal is limited to 6,000,000 V×Hz.

[4] For DCV-ACV dual measurement, the DCV input signal is limited to 500 V when ACV input signal is in 100 mV range. The ACV input signal must be greater than 50 mV.

[5] For ACI-DCV dual measurement operation frequencies, refer to [Table 2-4](#) on page 45

**Table 2-4** Measurement operation frequencies for DCV-ACI









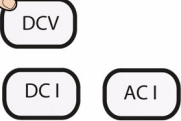

DCV-ACI	Measurement Operation Frequency
Slow/Medium	>500 Hz (600 Hz) / n x 50 Hz (60 Hz) for <500 Hz
Fast	>10 kHz / n x 1 kHz for <10 kHz

For more information, please refer to [Chapter 3](#), “Measurement Speed Consideration”.

## Using the dual display

To enable the dual display, follow the following steps:

## 2 Functions and Features

 <p>Typical single display screen</p>	 <p>Press to enable secondary display</p>
 <p>Select desired secondary measurement</p>	 <p>Typical dual display screen</p>
 <p>Press to control the secondary measurement</p>	 <p>Screen shows that secondary measurement is being controlled</p>
 <p>Select desired function for the secondary display</p>	<p>7-a</p>
 <p>Select desired range</p>	<p>7-b</p>
 <p>Select desired speed</p>	<p>7-c</p>
<p>8</p>  <p>Press to turn off secondary display</p> <p><b>Note:</b> For available measurements in the dual display mode, refer to table <a href="#">Table 2-3</a></p>	

For remote operation, refer to the DISPLAY:WINDOW2 commands in the *Agilent 34450A Programmer's Reference Helpfile*.

## Using the Utility Menu

The Utility menu allows you to customize a number of non-volatile instrument configurations. It also displays any SCPI error messages and the latest firmware revision codes.

The descriptions of the items in the Utility menu and their options are shown in [Table 2-5](#) on page 48

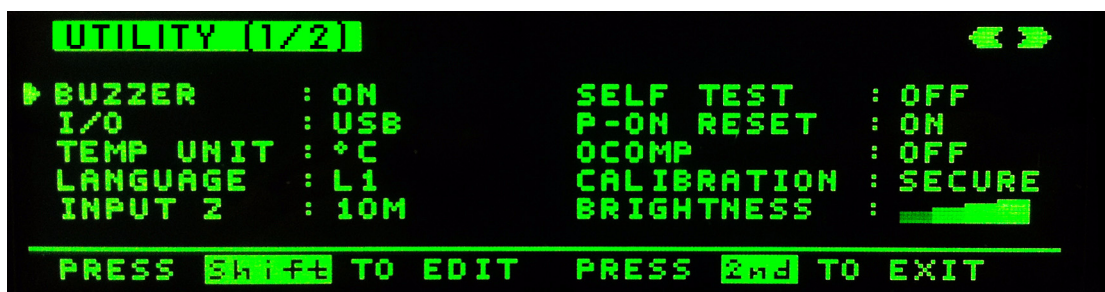

Figure 2-3 First page of the Utility menu





Figure 2-4 Second page of the Utility menu

## 2 Functions and Features

**Table 2-5** Utility menu available settings



Feature	Default	Available Settings	Description	Remote Command
BUZZER	ON	ON or OFF	Enables or disables Diode, Stats, Limit, and Hold beep operations. Turning off the buzzer does not disable the front panel keys beep operation and Continuity beep operation. Refer to <a href="#">“The beeper”</a> on page 55 for more info.	SYSTem: BEEPer: STATE
I/O	USB	USB, GPIB, or RS232	<ul style="list-style-type: none"> <li>Disables or enables the GPIB, USB, or RS232 remote interface</li> <li>If GPIB is selected, refer to <a href="#">“GPIB Utility Sub-Menu”</a> on page 53</li> <li>If RS232 is selected, refer to <a href="#">“RS232 utility sub-menu”</a> on page 51</li> <li>When all I/O are disabled, DISABLE is shown on the setting.</li> </ul>	SYSTem: COMMunicate: ENABle <mode>, <interface>
TEMP UNIT	°C	°C or °F	Selects the unit for temperature measurements	UNIT: TEMPerature <units>
LANGUAGE	L1	L1 or L2	L1 represents Agilent Mode L2 represents Fluke 45/8808A Mode. Refer to <a href="#">“Enabling the code compatibility function”</a> on page 73 for more info.	SYSTem: LANGUage
INPUT Z	10M	10M or HIGH Z	Sets the input impedance for DCV measurements (HIGH Z is selectable for 100 mV and 1 V ranges only)	[SENSe:] VOLTage[:DC ]: IMPedance: AUTO <mode>
SELF TEST	OFF	ON or OFF	ON enables an immediate self-test of the multimeter. Returns to normal operation after completing the self-test.	*TST?
P-ON RESET	ON	ON or OFF	Disables or enables the automatic recall of the powered down state when power is turned on	MEMory: STATE: RECall : AUTO
OCOMP	OFF	ON or OFF	Enables or disables the offset compensation for resistance measurement	[SENSe:] RESistance: OCOMpe nsated <mode>

**Table 2-5** Utility menu available settings (continued)

CALIBRATION	SECURE	SECURE or UNSEC	To secure or unsecure the calibration adjustments to the instrument. Selecting it will open the [Calibration Sub-Menu]	CALibration:SECure: STATE <mode>, <code>
Feature	Default	Available Settings	Description	Remote Command
BRIGHTNESS			Allows you to toggle the brightness on the multimeter's display	-
SCPI ERR	NONE	NONE or (Error Message)	Available Settings; NONE or (Number of errors) Description; If there are errors, selecting it will open the [SCPI Error Sub-Menu]	SYSTEM:ERROR?
FW VER	-	XX.XX - XX.XX	Displays the multimeter's firmware revision. The first 4 digits are the IO firmware revision, while the last 4 digits are the measurement firmware revision.	-



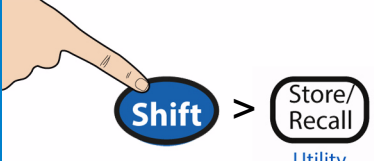

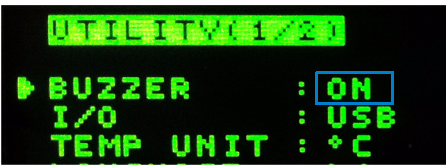
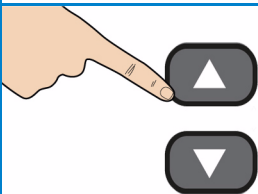
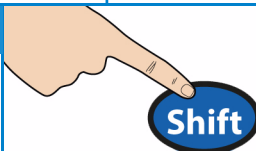
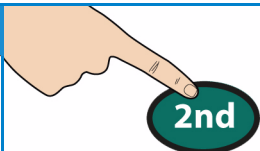

## 2 Functions and Features

Below are the steps you should follow if you want to edit any of the values on the utility menu:

<p>1</p>  <p>Press to display the utility menu</p>	<p>2</p>  <p>Page one of utility menu</p>	
<p>3</p>  <p>Press to edit</p>	<p>4</p>  <p>This option will flash, enabling you to edit</p>	
<p>5</p>  <p>Select the desired value</p>	<p>6</p>  <p>Press to save</p>	<p>7</p>  <p>Press to exit</p>

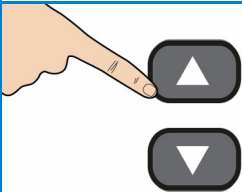
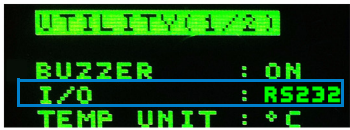
## RS232 utility sub-menu

To enable the RS232 option, follow the steps below. For a list of RS232 settings, see [Table 2-6](#) on page 52.

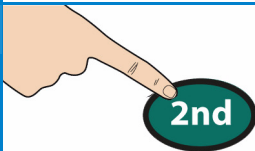
 <p>Select I/O option</p>	<p>1</p>  <p>2</p> <p>Press to edit</p>
 <p>Press to select RS232 option</p>	<p>3</p>  <p>4</p>  <p>5</p> <p>Press to edit RS232 option</p>
 <p>Typical RS232 sub menu display</p>	<p>6</p>  <p>7</p>  <p>8</p> <p>Press to edit/save</p> <p>Press to return to utility menu</p>

**Table 2-6** RS232 utility sub-menu

<b>Option</b>	<b>Default Setting</b>	<b>Available Settings</b>	<b>Description</b>
BAUD RATE	9600	300, 600, 1200, 2400, 4800, 9600, 19200, 38400, 57600	Baud rate for remote communication with a PC (remote control)
PARITY	NONE	NONE, ODD, EVEN	Parity bit for remote communication with a PC
DATA BIT	8	7, 8	Data bit length
STOP BIT	1	1, 2	Stop bit length
State	Disable	Disable, Enable	Enable or disable RS232

## GPIB Utility Sub-Menu

To activate GPIB, first, turn on the GPIB option. The following pop-up message will appear if the GPIB license key is not activated :



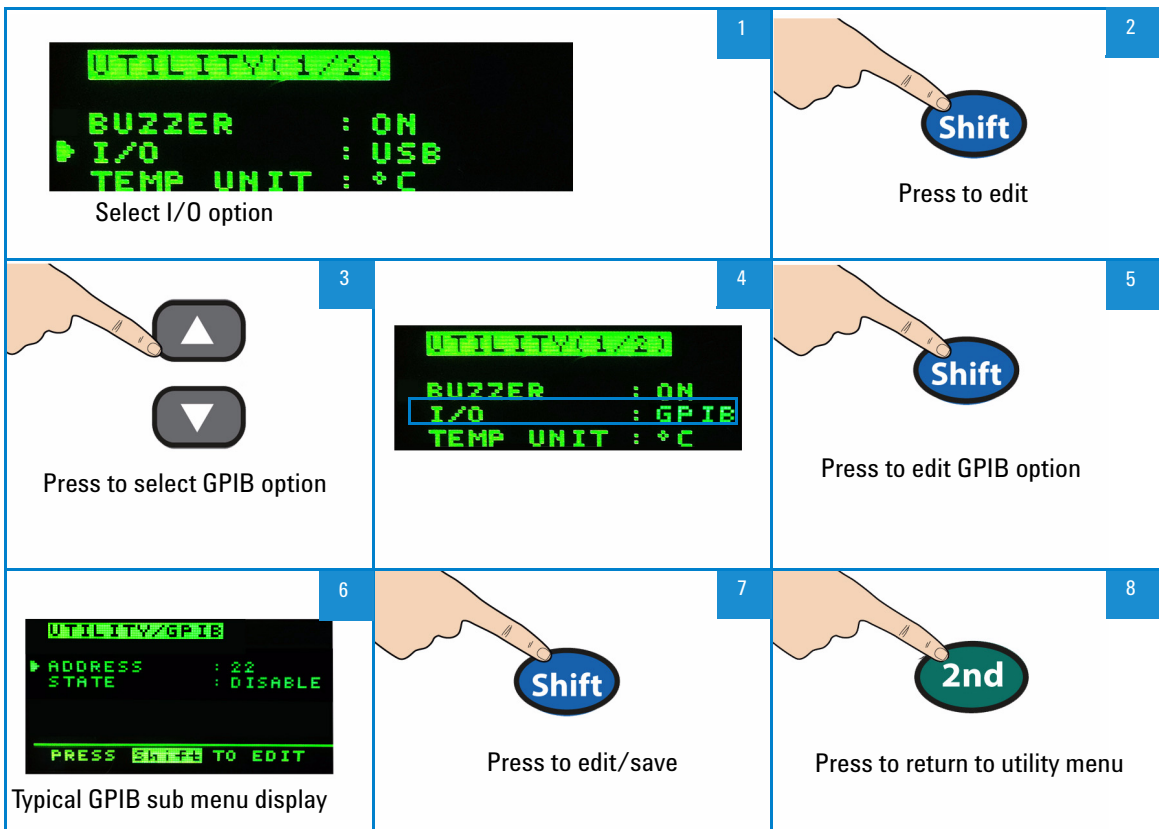

“GPIB is not enabled, to enable, please visit [www.agilent.com/find/34450A](http://www.agilent.com/find/34450A)”

If GPIB connectivity is selected, a sub-menu will appear to allow you configure the address (from 0 to 30) for remote communication to a PC.

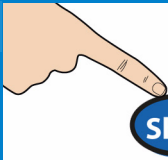

## Reading error messages

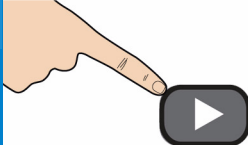
To read error messages from the front panel, perform the following procedures. For remote operation, refer to the `SYSTEM:ERROR?` command in the *Agilent 34450A Programmer's Reference Helpfile*.

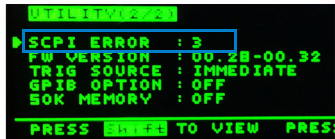
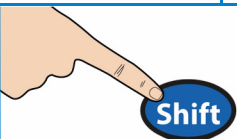
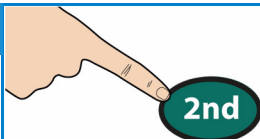
 <p>Typical display with error message</p>	<p>1</p>  <p>2</p>  <p>Press to display the utility menu</p>
	<p>3</p>  <p>4</p>  <p>Press to navigate to the second page of utility menu</p>
	<p>5</p>  <p>6</p>  <p>7</p> <p>Press to view error</p> <p>Press to exit</p>

## The beeper

Normally, the multimeter beeps whenever certain conditions are met (for example, the multimeter beeps when a stable reading is captured in reading hold mode).

The beeper is factory set to **ON**, but may be disabled or enabled manually.

- Turning **OFF** the beeper does **NOT** disable the front panel keys beep tones.
- A beep tone is always emitted (even with the beep state turned **OFF**) in the following cases:
  - A continuity measurement is less than or equal to the continuity threshold.
  - A `SYSTEM:BEEPer` command is sent.
  - An error is generated.
- In addition to the beep operations just described, when the beeper is **ON**, a single beep occurs for the following cases (turning the beeper **OFF** disables the beep for the following cases):
  - When a new **MIN** or **MAX** value is stored
  - When a new stable reading is updated on display for Math Hold operation
  - When a measurement exceeds the HI or LO Limit value
  - When a forward-biased diode is measured in the Diode function

## Storing and Recalling Instrument States

The present multimeter state, including all settings for measurement configuration, math operation, and system operations, can be saved in one of the six non-volatile memory locations and later recalled. Location LAST retains the multimeter configuration at power down. Locations LAST and 1-5 are available for storing the configurations.

To recall instrument states, perform the following steps:

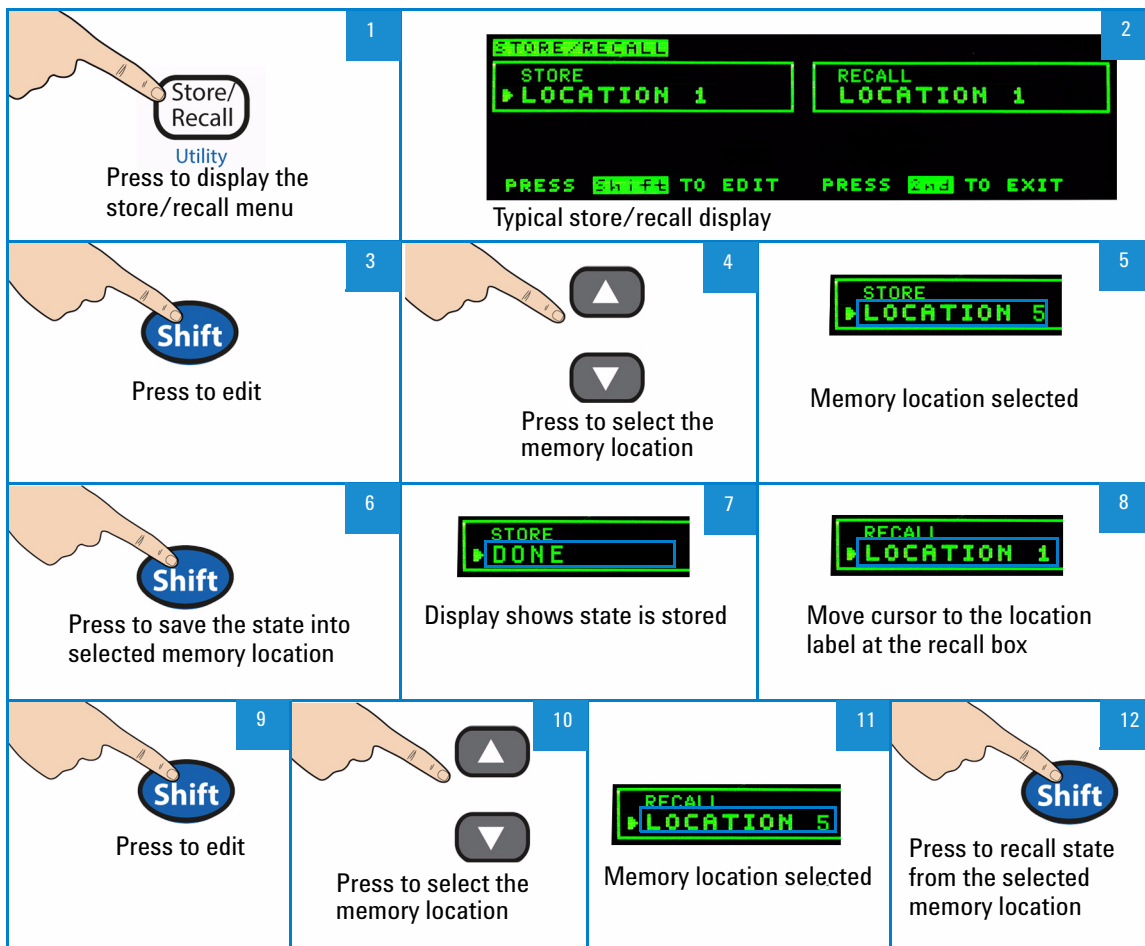

For remote operation, refer to the MEMORY Subsystem, the \*SAV, and \*RCL commands in the *Agilent 34450A Programmer's Reference Helpfile*.

## Reset/Power-On State

The table below summarizes the 34450A settings as received from the factory, following power cycling, and following the \*RST command received over the USB remote interface. Non-volatile, user customizable behavioral differences are shown in **BOLD**.

**Table 2-7** Reset/Power-on state

Parameter	Factory Setting	Power-On / Reset State
<b>Measurement Configuration</b>		
Function	DCV	DCV
Range	AUTO	AUTO
Resolution	5½ digits	5½ digits
Temperature Units	°C	<b>User setting</b>
<b>Math Operations</b>		
Math State, Function	Off, Null	Off, Null
Math Registers	Cleared	Cleared
dBm Reference Resistance	600 Ω	<b>User setting</b>
<b>Trigger Operation</b>		
Trigger Source <sup>[1]</sup>	Auto Trigger (Local Mode) IMMediate (Remote Mode)	Auto Trigger (Local Mode) IMMediate (Remote Mode)
<b>System-Related Operation</b>		
Power-Down Recall	Disabled	<b>User Setting</b>
Stored States	0-5 cleared	No Change
Beeper	On	<b>User Setting</b>
Display	On	On
Remote/ Local State	Local	Local
Keyboard <sup>[1]</sup>	Unlocked, Local key enabled	Unlocked, Local key enabled

**Table 2-7** Reset/Power-on state (continued)

Parameter	Factory Setting	Power-On / Reset State
Reading Output Buffer <sup>[1]</sup>	Cleared	Cleared
Error Queue <sup>[1]</sup>	Cleared	Cleared if power cycle
Power-on Status Clear <sup>[1]</sup>	Enabled	User Setting
Status Registers, Masks & Transition Filters <sup>[1]</sup>	Cleared	<b>Cleared if power-on status clear enabled</b> ; no change otherwise
Serial Number	Unique value per-instrument	No Change
<b>Calibration</b>		
Calibration state	Secured	User Setting
Calibration value	0	No Change
Calibration String	Cleared	No Change

[1] State managed by IO processor firmware

## Triggering the Multimeter

At power-on, the default trigger source is auto-triggering. Auto-triggering takes continuous readings at the fastest rate possible for the selected measurement configuration. To make a trigger measurement, follow the steps below:

- 1 Configure the multimeter for the measurement by selecting the function, range, resolution, and so on.
- 2 Specify the multimeter's trigger source. Choices are as below:
  - Software (bus) trigger from the remote interface.
  - An immediate internal trigger (default trigger source).
  - An external trigger from an external trigger pulse.
- 3 Ensure that the multimeter is ready to accept a trigger from the specified source (called the *wait-for-trigger* state).

### Immediate Triggering

*The immediate triggering mode is available from the remote interface only.*

In the *immediate* trigger mode, the trigger signal is always present. When you place the multimeter in the wait-for-trigger state, the trigger is issued immediately. This is the default trigger source for remote interface operation.

- **Remote Interface Operation:** The following command selects the immediate trigger source:

```
TRIGger:SOURce IMMEDIATE
```

The `CONFigure` and `MEASure?` commands automatically set the trigger source to `IMMEDIATE`.

Refer to the *Agilent 34450A Programmer's Reference Helpfile* for complete description and syntax for these commands.

## Software (Bus) Triggering

*The bus trigger mode is available from the remote interface only.*

The bus trigger mode is initiated by sending a bus trigger command, after selecting BUS as the trigger source.

- The TRIGger:SOURce BUS command selects the bus trigger source.
- The MEASure? command overwrites the BUS trigger and triggers the DMM and returns a measurement.
- The READ? command does not overwrite the BUS trigger, and if selected, generates an error. It will only trigger the instrument and return a measurement when the IMMEDIATE trigger is selected.
- The INITiate command only initiates the measurement and needs a trigger (BUS or EXTERNAL or IMMEDIATE) to make the actual measurement.

Refer to the *Agilent 34450A Programmer's Reference Helpfile* for the complete description and syntax for these commands.

### External Trigger

External triggering takes one reading (or the specified number of readings in data logger) each time the multimeter receives a pulse on the rear-panel external trigger connector. The multimeter uses the rising edge (POS) of the external trigger signal to trigger a reading. Diagram below shows the external trigger connector:

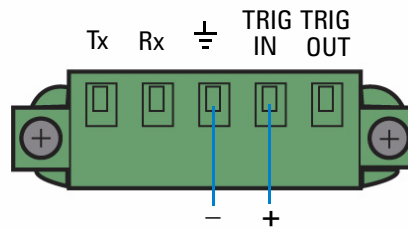

**Figure 2-5** Trigger in connector

The trigger annunciator turns on when the multimeter is waiting for an external trigger.

The rear panel trigger out connector provides a pulse after the completion of each measurement. Trigger out and external trigger implement a standard hardware handshake sequence between measurement and switching devices.

### Trigger Out

The Trigger out signal cannot be configured and is implemented in four ways:

In local mode, a trigger out signal is sent whenever a measurement is updated on the front panel.

In remote mode, a trigger out signal is sent whenever a measurement is taken by the user through using command.

In data log/external trigger mode, a trigger out signal is sent whenever a measurement is log/triggered and updated on the front panel.

In code compatibility mode, a trigger out signal is sent whenever a measurement is updated on the front panel or a measurement is taken by the user using command. The diagram below shows the trigger out connector:

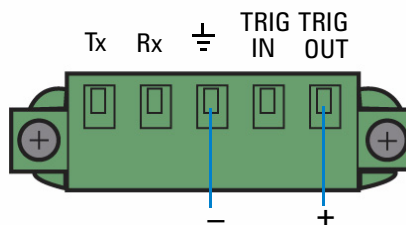

**Figure 2-6** Trigger out connector

### Manual Trigger

Manual triggering takes one reading (or the specified number of readings in data logger) each time the multimeter receives a pulse on the front-panel trigger button. The diagram below shows the manual trigger operation:

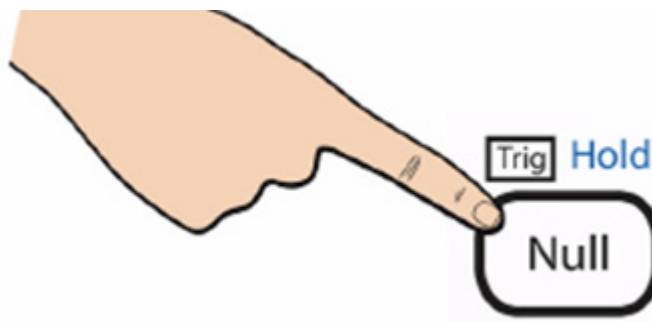

The trigger annunciator turns on when the multimeter is waiting for a manual trigger. The rear panel trigger out connector provides a pulse after the completion of each

## 2 Functions and Features

measurement. Trigger out and manual trigger implement a standard hardware handshake sequence between measurement and switching devices.

## Data Logging

The data logger feature provides a front-panel interface that allows you to set up data logging into the instrument's non-volatile memory with programming, and without a connection to a computer.







Once you have finished collecting data, you can view it from the front panel, or you can also connect your computer and import the data using the `DATA:DATA? NVMEM` command.

The instrument is connected through the enable log configuration and will begin to log measurement data once an external pulse is received through the terminal or the trigger button is pressed. Once data logging is enabled, all IO connectivity will be disabled. The IO connectivity will be restored when the data logging has been completed or aborted.

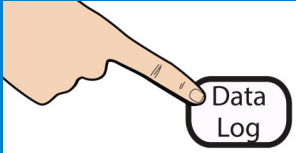
The 34450A has memory for up to 50,000 readings which is the maximum limit for the data logger feature.

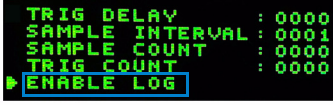
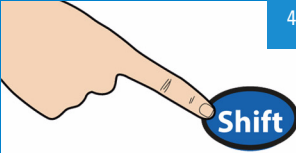
## 2 Functions and Features

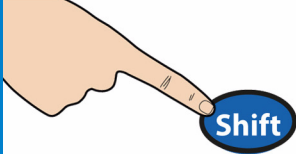
Below are the steps to enable data logging:

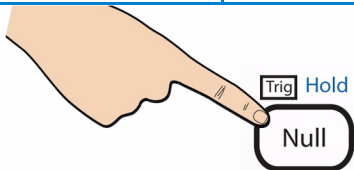
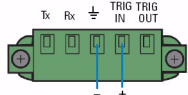





<p>1</p>  <p>Press to enable data log menu</p>	<p>2</p>  <p>Typical data log menu display</p>	
<p>3</p>  <p>Move cursor to enable logging</p>	<p>4</p>  <p>Press to execute</p>	<p>5</p>  <p><b>Note:</b> Enabling new log data will automatically delete previous log</p>
<p>6</p>  <p>Press to proceed</p>	<p>7</p>  <p>Typical data log menu screen</p>	
<p>8</p>  <p>Press the trigger button (manual triggering) or wait for an external pulse (external triggering) to begin data logging</p> <p>OR</p> 		

**Table 2-8** Data log menu options

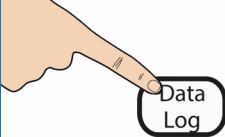
Option	Available settings	Description
TRIGGER DELAY	0 to 3600 seconds	Delay time between a trigger is initiated and first reading is taken by the data log function. The smallest delay time resolution is 100 $\mu$ s.
SAMPLE INTERVAL	1 to 3600 seconds	Delay time between subsequent readings. The smallest resolution is 100 $\mu$ s. The minimum interval is configuration dependent and may be lower than 1 s.
SAMPLE COUNT	1 to 5000 (single display measurement) 1 to 2500 (dual display measurement)	Total readings that need to be logged. It can be configured from 1 to 5000 readings for single display measurement (upgrade to 50,000 with option 3445MEMU) and 2500 readings for dual display measurement (upgrade to 25,000 with option 3445MEMU).
TRIGGER COUNT	1 to 5000 (single display measurement) 1 to 2500 (dual display measurement)	Total triggers that will be received. It can be configured from 1 to 5000 triggers for single display measurement (upgrade to 50,000 with option 3445MEMU) and 2500 triggers for dual display measurement (upgrade to 25,000 with option 3445MEMU).
ENABLE LOG	-	To start the log function. During logging, all keys are locked. To stop the log function, press any key except TRIG key follow by SHIFT key.



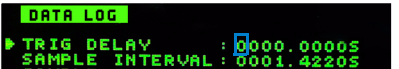
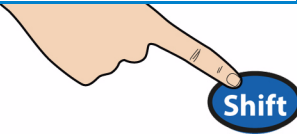
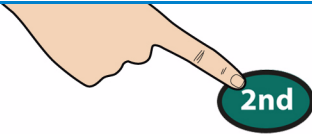

## 2 Functions and Features

To edit the trigger delay, sample interval, sample count, and trigger count in the data log menu, follow the steps below:

<p>1</p>  <p>Press to enable data log menu</p>	<p>2</p>  <pre>DATA LOG ▶ TRIG DELAY      : 0000.0000S SAMPLE INTERVAL  : 0001.4220S SAMPLE COUNT     : 00001 TRIG COUNT       : 00001 ENABLE LOG PRESS [Shift] TO EDIT PRESS [Esc] TO EXIT</pre> <p>Typical data log menu display</p>
<p>3</p>  <p>Press to edit</p>	<p>4-a</p>  <p>Press for digit selection</p>  <pre>DATA LOG ▶ TRIG DELAY      : 0000.0000S SAMPLE INTERVAL  : 0001.4220S</pre>
<p>4-b</p>  <p>Press to change the value of selected digit</p>  <pre>DATA LOG ▶ TRIG DELAY      : 0000.0000S SAMPLE INTERVAL  : 0001.4220S</pre>	
<p>5</p>  <p>Press to save</p>	<p>6</p>  <p>Press to exit</p>

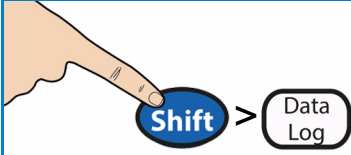

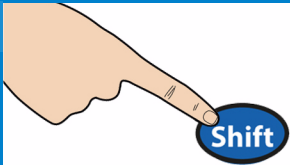
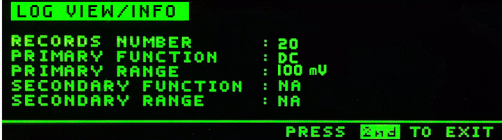









## Viewing the log info

Log info page shows the record number of the log data, function, and range for the primary and secondary measurement when data is logged. If no data is available for that log, NA is displayed.

<p>1</p>  <p>Press to display data log menu</p>	<p>2</p>  <p>Typical log view menu display</p>
<p>3</p> 	<p>4</p>  <p>Press to select log info</p>
<p>5-a</p>  <p>Typical log info display when only primary measurement is performed</p>	<p>6</p> 
<p>5-b</p>  <p>Typical log info display when both primary and secondary measurements are performed</p>	<p>Press to exit</p>





## Viewing the log list

To view the log list, follow the steps below:

<p>1</p>  <p>Shift &gt; Data Log</p> <p>Press to display data log menu</p>	<p>2</p>  <p>Typical log view menu display</p>
<p>3</p>  <p>Move cursor to log list menu</p>	<p>4</p>  <p>Shift</p> <p>5</p>  <p>Typical log list first page display when only the primary measurement is performed during data log</p>
<p>6</p>  <p>Press to switch pages</p>	<p>7</p>  <p>Typical log list first page display when both primary and secondary measurements are performed during data log</p> <p>8</p>  <p>Shift</p> <p>Press to find specific log data</p>
<p>9</p>  <p>Finding specific log data page display</p>	<p>10-a</p>  <p>FIND NO : 00000</p> <p>Press for digit selection</p> <p>10-b</p>  <p>FIND NO : 00000</p> <p>Press to change the value of selected digit</p>
<p>11</p>  <p>Shift</p> <p>Press to find</p>	<p>12</p>  <p>2nd</p> <p>Press to exit</p>

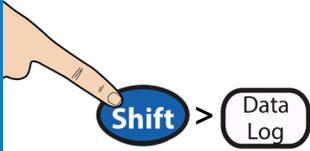

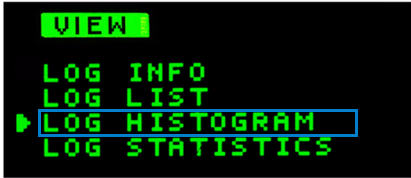
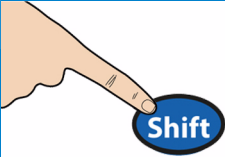
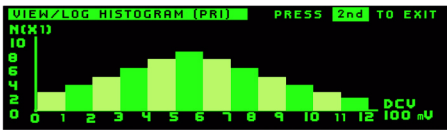
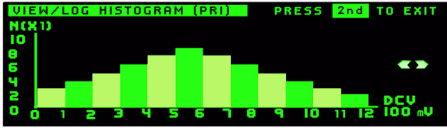
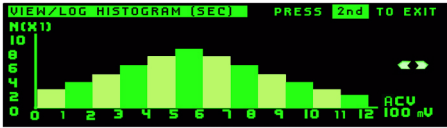
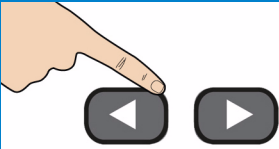



## Viewing the log histogram

To view the log histogram, follow the steps below:

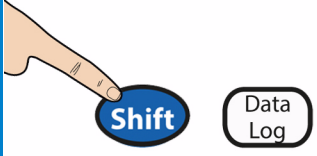
<p>1</p>  <p>Press to display data log menu</p>	<p>2</p>  <p>Typical log view menu display</p>
<p>3</p>  <p>Move cursor to the histogram menu</p>	<p>4</p>  <p>Press to select</p>
<p>5</p>  <p>Typical histogram display without secondary measurement function</p>  <p>Typical histogram display for primary measurement with secondary measurement active</p>  <p>Typical histogram display for secondary measurement with secondary measurement active</p>	<p>6</p>  <p>Press to switch between primary or secondary data</p> <p>7</p>  <p>Press to exit</p>

## Viewing the log statistics





To view the log statistics, follow the steps below:

<p>1</p>  <p>Press to display data log menu</p>	<p>2</p>  <p>Typical log view menu display</p>
<p>3</p>  <p>Move cursor to the log statistics menu</p>	<p>4</p>  <p>Press to select</p>
<p>5</p>  <p>Typical log statistics display</p>	<p>6</p>  <p>Press to exit</p>

# Fluke 45/Fluke 8808A Code Compatibility Mode

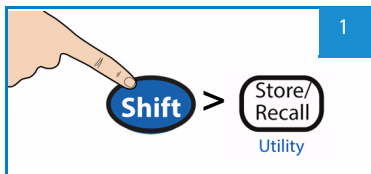
The code compatibility mode enables the user to enter remote commands easily when migrating from one instrument to the next.

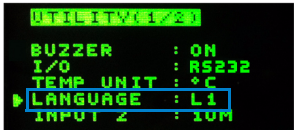
## Enabling the code compatibility function

<p>1</p>  <p>Press to display utility menu</p>	<p>2</p>  <p>Typical log utility menu display</p>
 <p>Move cursor to LANGUAGE and change to L2</p>	<p>3</p> <p><b>Note:</b> RS232 or GPIB connectivity must be enabled in order for the code compatibility mode to work. Once the code compatibility mode is on, the USB connectivity will be disabled.</p>
<p>4</p>  <p>Press to save</p>	<p>5</p>  <p>Typical code compatibility mode screen display</p>

## Notes for Fluke 45/Fluke 8808A code compatibility mode

- When the code compatibility function is enabled, the front panel will be in a locked state except the utility menu.
- Reset is performed on the multimeter whenever the code compatibility function is turned on or turned off.
- Rate is global for every function when the code compatibility mode is enabled.
- The temperature or capacitance measurement function will be disabled when the multimeter is in code compatibility mode.
- The multimeter automatically enters code compatibility mode when switched on if the code compatibility function was previously enabled before being turned off.
- In code compatibility mode, whenever a primary measurement function is changed, the secondary display function is turned off.



### 3 Measurement Tutorial

DC Measurement Considerations	76
Noise Rejection	77
Measurement Speed Consideration	80
Dual Measurement Considerations	81
Resistance Measurement Considerations	84
True RMS AC Measurements	87
Other Primary Measurement Functions	91
Other Sources of Measurement Error	96

The Agilent 34450A multimeter is capable of making very accurate measurements. In order to achieve the greatest degree of accuracy, you must take the necessary steps to eliminate potential measurement errors. This chapter describes the common errors found in measurements and gives suggestions on what you can do to avoid these errors.



## DC Measurement Considerations

### Thermal EMF Errors

Thermoelectric voltages are the most common source of error in low-level DC voltage measurements. Thermoelectric voltages are generated when you make circuit connections using dissimilar metals at different temperatures. Each metal-to-metal junction forms a thermocouple, which generates a voltage proportional to the junction temperature. You should take the necessary precautions to minimize thermocouple voltages and temperature variations in low-level voltage measurements. The best connections are formed using copper-to-copper crimped connections, as the multimeter's input terminals are a copper alloy. The table below shows common thermoelectric voltages for connections between dissimilar metals.

**Table 3-1** Common thermoelectric voltages for connections between dissimilar metals

Copper -to-	Approx. mV / °C
Cadmium-Tin Solder	0.2
Copper	<0.3
Gold	0.5
Silver	0.5
Brass	3
Beryllium Copper	5
Aluminum	5
Tin-Lead Solder	5
Kovar or Alloy 42	40
Silicon	500
Copper-Oxide	1000

# Noise Rejection

## Rejecting Power-Line Noise Voltages

A desirable characteristic of integrating analog-to-digital (A/D) converters is their ability to reject power-line related noise present with DC input signals. This is called normal mode noise rejection, or NMR. The multimeter achieves NMR by measuring the average DC input by “integrating” it over a fixed period.

## Common Mode Rejection (CMR)

Ideally, a multimeter is completely isolated from earth-referenced circuits. However, there is finite resistance between the multimeter’s input LO terminal and earth ground, as shown below. This can cause errors when measuring low voltages which are floating relative to earth ground.

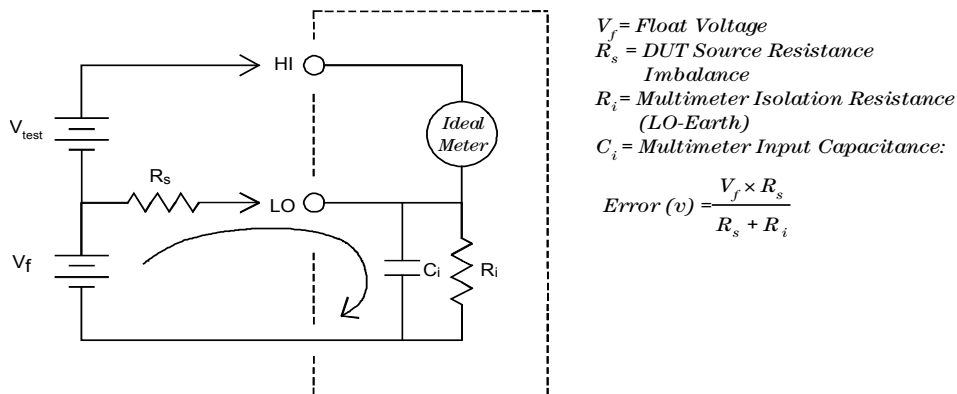

**Figure 3-1** Common Mode Rejection (CMR)

### **Noise Caused by Magnetic Loops**

If you are making measurements near magnetic fields, take caution to avoid inducing voltages in the measurement connections. You should be especially careful when working near conductors carrying large currents. Use twisted-pair connections to the multimeter to reduce the noise pickup loop area, or dress the test leads as close together as possible. Loose or vibrating test leads will also induce error voltages. Tie down test leads securely when operating near magnetic fields. Whenever possible, utilize magnetic shielding materials or increase the distance from magnetic sources.

### **Noise Caused by Ground Loops**

When measuring voltages in circuits where the multimeter and the device-under-test are both referenced to a common earth ground, a ground loop is formed. As shown in [Figure 3-2](#) on page 79, any voltage difference between the two ground reference points ( $V_{\text{ground}}$ ) causes a current to flow through the measurement leads. This causes noise and offset voltage (usually power-line related), which are added to the measured voltage.

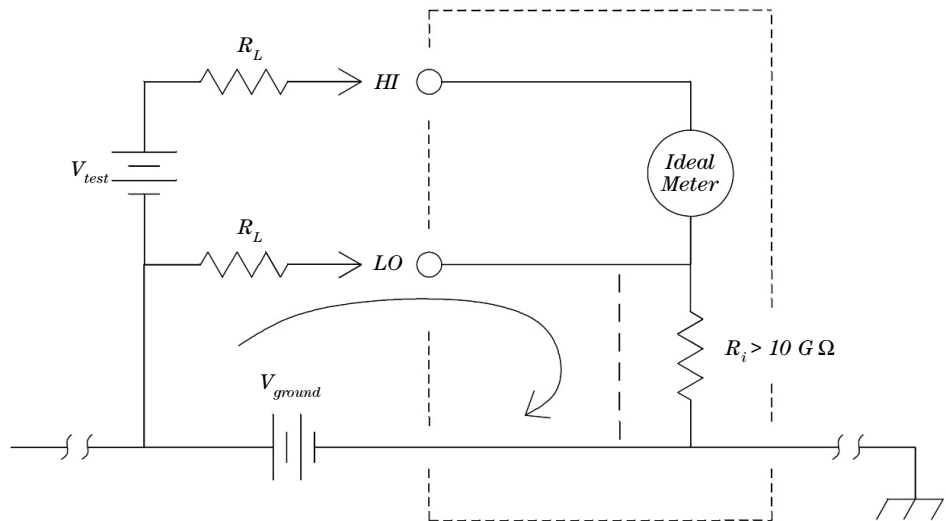

$R_L$  = Lead Resistance  
 $R_i$  = Multimeter Isolation Resistance  
 $V_{ground}$  = Voltage Drop on Ground Bus

**Figure 3-2** Noise caused by ground loops

The best way to eliminate ground loops is to isolate the multimeter from earth by *not* grounding the input terminals. If the multimeter must be earth-referenced, connect it and the device-under-test to the same common ground point. Also connect the multimeter and the device-under-test to the same electrical outlet whenever possible.

## Measurement Speed Consideration

There are two methods of integrating the sampled data taken in the measurement, slow/medium (NPLC) and fast (Aperture).

When you set the resolution to slow or medium, you can not only achieve improved accuracy associated with time averaging, but also achieve the rejection of the power-line interference (normal mode rejection, or NMR).

Aperture is the period, measured in seconds, during which the multimeter's analog-to-digital (A/D) converter samples the input signal for a measurement. A longer aperture yields better resolution; a shorter aperture provides faster measurements. The fast mode set a specific 1 ms measurement period, not based on power line frequency. No normal mode rejection is provided in aperture mode.

## Dual Measurement Considerations

The dual measurements mode allows users to make two measurements in one display. During dual measurement mode, the display will show two separate measurements and there is a switching delay between both measurements.

The table below shows some of the applications that can be measured using dual measurement mode:

Dual Functions Combinations	Application
DCV & ACV	Measure AC signal with DC offset from an amplifier output. Measure AC ripple noise and DC output voltage from a power supply
DCV & DCI	Measure DC voltage and DC current on a electronic circuit
DCV & ACI	Inverter application
ACV & DCI	Inverter application
ACV & ACI	Measure primary & secondary signal of a transformer circuit
ACV / ACI & Freq	Measure frequency of the line voltage

### DC voltage dynamic range in dual measurement

When measuring DC and AC in dual measurement mode, make sure the DC + AC components do not exceed the multimeter ADC dynamic range. The 34450A has a dynamic range of  $\pm 1.2$  V or 120% of full scale for each DCV ranges.

For example, the DC offset of the signal as shown in [Figure 3-3](#) causes the input to exceed the upper limit ADC dynamic range. This may cause errors in DC component measurement.

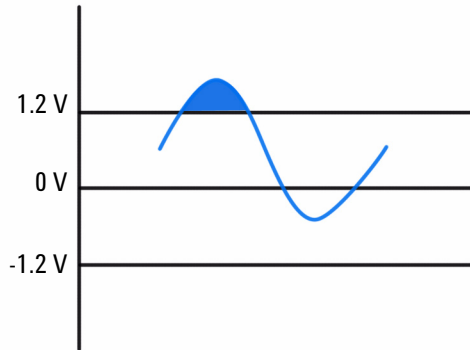

**Figure 3-3** ADC Dynamic Range

Consider an AC component of 1 Vrms signal with a DC offset of 100 mV. When measuring at DCV 1 V range,  $V_{peak}$  of the signal is 1.514 V which exceeds the ADC dynamic range of 1.2 V, causing an error in DC measurement.

Select a higher range DCV 10 V range for better accuracy.

The same error of measurement applies to DCV and ACI dual mode caused by the multimeter's series burden voltage.

## Voltage and current in dual measurement

When measuring DC voltage and DC current in dual measurement mode, take into account the resistance of the test lead and internal measuring circuitry. The 34450A shares the same common ground both in DC voltage and DC current measurement. When a current flow through the LO terminal, a voltage drop will occur in the circuit and will affect the accuracy of the voltage reading.

Considering the internal resistance and external lead resistance total is 0.0125 ohm. If applying a 1 A DC current, an error of  $(0.0125 \text{ ohm} \times 1 \text{ A})$  0.0125 V or 12.5 mV will occur. This error will be relative by range with the ADC dynamic range of 1.2 V.

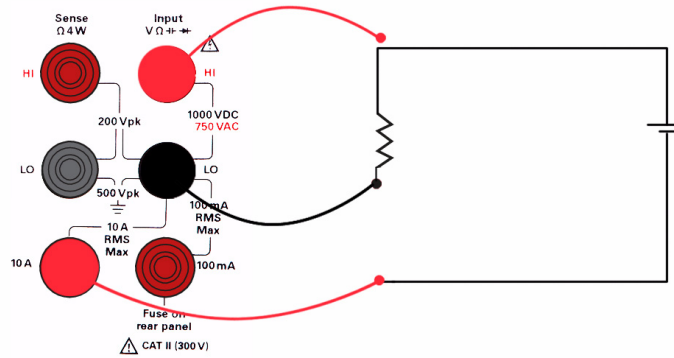

**Figure 3-4** Example of measuring voltage and current in dual measurement

The error in measurement will be significant when applying a higher current.

## Resistance Measurement Considerations

When measuring resistance, the test current flows from the input HI terminal through the resistor being measured. The voltage drop across the resistor being measured is sensed internal to the multimeter. Therefore, test lead resistance is also measured.

*The errors mentioned earlier in this chapter for DC voltage measurements also apply to resistance measurements. Additional error sources unique to resistance measurements are discussed here.*

### Removing Test Lead Resistance Errors

To eliminate offset errors associated with test lead resistance, refer to “[Null measurement](#)” on page 33

### Minimizing Power Dissipation Effects

When measuring resistors designed for temperature measurements (or other resistive devices with large temperature coefficients), be aware that the multimeter will dissipate some power in the device-under-test (DUT).

If power dissipation is a problem, you should select the multimeter’s next higher measurement range to reduce the errors to acceptable levels. The following table shows several examples.

**Table 3-2** Examples of measurement ranges

Range	Test Current	DUT Power at Full Scale
100 $\Omega$	1 mA	100 $\mu$ W
1 k $\Omega$	0.5 mA	250 $\mu$ W
10 k $\Omega$	100 $\mu$ A	100 $\mu$ W
100 k $\Omega$	10 $\mu$ A	10 $\mu$ W
1 M $\Omega$	1 $\mu$ A	1 $\mu$ W

**Table 3-2** Examples of measurement ranges (continued)

Range	Test Current	DUT Power at Full Scale
10 M $\Omega$	100 nA	100 nW
100 M $\Omega$	100 nA / 10 M $\Omega$	1 $\mu$ W

### Errors in High Resistance Measurements

When you are measuring large resistances, significant errors can occur due to resistance insulation and surface cleanliness. You should take the necessary precautions to maintain a “clean” high-resistance system. Test leads and fixtures are susceptible to leakage due to moisture absorption in insulating materials and “dirty” surface films. Nylon and PVC are relatively poor insulators ( $10^9 \Omega$ ) when compared to PTFE insulators ( $10^{13} \Omega$ ).

Leakage from nylon or PVC insulators can easily contribute a 0.1% error when measuring a 1 M $\Omega$  resistance in humid conditions.

### Offset Compensation

A resistance measurement involves measuring a voltage (E) induced across the resistance by a known current source.

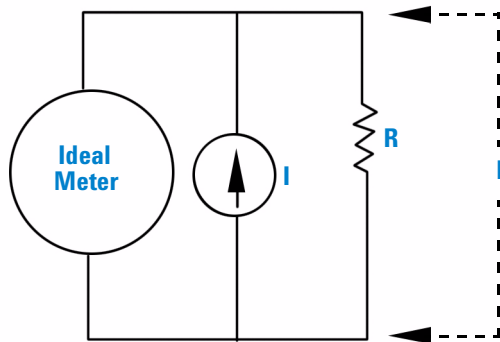

Thermal EMF caused by dissimilar metals can create a parasitic voltage in the measurement circuit (VEMF). The thermal EMF can be caused by the input lead connections or internally in resistor R. In general, this voltage will not change with the current applied to the resistor.

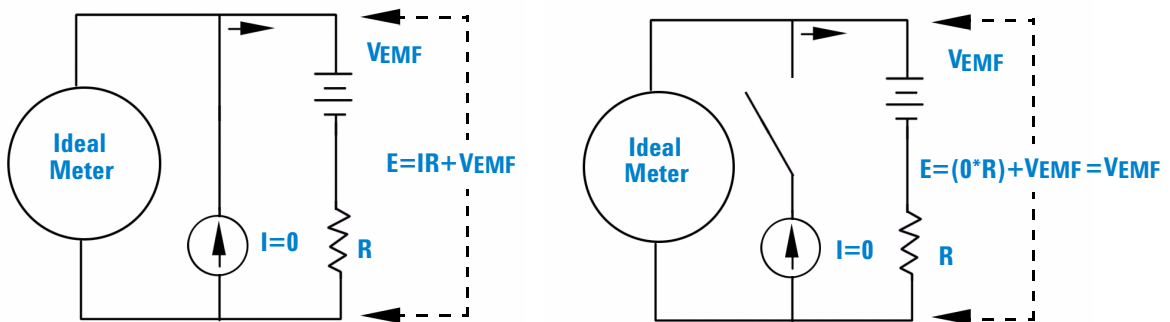

The voltage measured, and so the resistance calculated, is in error by VEMF. Using offset compensation can reduce the errors caused by VEMF. To make an offset compensated measurement, the meter makes two voltage measurements, one with the current source on and one with the current source off, and subtracts the two measurements. The actual voltage drop across the resistor, and the calculated resistance are obtained by:

$$\text{First Reading} - \text{Second Reading} = (I \cdot R + VEMF) - VEMF = I \cdot R$$

Offset compensation can be used in 2-Wire or 4-Wire ohms measurements (only available on 100 Ω, 1 kΩ and 10 kΩ).

## True RMS AC Measurements

True RMS responding multimeters, like the 34450A, measure the “heating” potential of an applied voltage. Power dissipated in a resistor is proportional to the square root of an applied voltage, independent of the waveshape of the signal. This multimeter accurately measures true RMS voltage or current, as long as the wave shape contains negligible energy above the instrument’s effective bandwidth.

Note that the 34450A uses the same techniques to measure true RMS voltage and true RMS current.

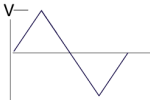
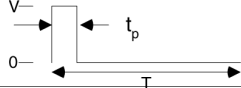
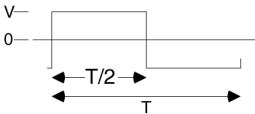
Waveform Shape	Crest Factor	AC RMS	AC + DC RMS
	$\sqrt{2}$	$\frac{V}{\sqrt{2}}$	$\frac{V}{\sqrt{2}}$
	$\sqrt{3}$	$\frac{V}{\sqrt{3}}$	$\frac{V}{\sqrt{3}}$
	$\sqrt{\frac{T}{t_p}}$	$\frac{V}{CF} \times \sqrt{1 - \frac{1}{CF^2}}$	$\frac{V}{CF}$
	1	V	V

The multimeter’s AC voltage and AC current functions measure the *AC-coupled* true RMS value. In this Agilent instrument, the “heating value” of *only the AC components* of the input waveform are measured (DC is rejected). As seen in the figure above; for sinewaves, triangle waves, and square waves, the *AC-coupled* and *AC+DC* values are equal since these waveforms do not contain a DC offset. However, for non-symmetrical waveforms, such as pulse trains, there

is a DC voltage content, which is rejected by Agilent's AC-coupled true rms measurements. This can provide a significant benefit.

An AC-coupled true rms measurement is desirable when you are measuring small AC signals in the presence of large DC offsets. For example, this situation is common when measuring AC ripple present on DC power supplies. There are situations, however, where you might want to know the AC+DC true RMS value. You can determine this value by combining results from DC and AC measurements, as shown below:

$$ac + dc = \sqrt{ac^2 + dc^2}$$

For the best AC noise rejection, you should perform the DC measurement at s-mode.

### True RMS Accuracy and High-Frequency Signal Content

A common misconception is that “since an AC multimeter is true RMS, its sine wave accuracy specifications apply to all waveforms.” Actually, the shape of the input signal can dramatically affect measurement accuracy, for any multimeter, especially when that input signal contains high-frequency components which exceed the instrument's bandwidth. Error in RMS measurements arise when there is significant input signal energy at frequencies above the multimeter's bandwidth.

### Estimating High-Frequency (Out-of-Band) Error

A common way to describe signal waveshapes is to refer to their “Crest Factor”. Crest factor is the ratio of the peak value to RMS value of a waveform. For a pulse train, for example, the crest factor is approximately equal to the square root of the inverse of the duty cycle.

$$CF = \frac{1}{\sqrt{d}} = \frac{1}{\sqrt{\frac{t_p}{T}}} = \frac{1}{\sqrt{prf \times t_p}}$$

Notice that crest factor is a composite parameter, dependent upon the pulse-width and repetition frequency; crest factor alone is not enough to characterize the frequency content of a signal.

Traditionally, digital multimeters include a crest factor derating table that applies at all frequencies. The measurement algorithm used in the 34450A multimeter is not inherently sensitive to crest factor, so no such derating is necessary. With this multimeter, as discussed in the previous section, the focal issue is high-frequency signal content which exceeds the multimeter's bandwidth.

For periodic signals, the combination of crest factor and repetition rate can suggest the amount of high-frequency content and associated measurement error. The first zero crossing of a simple pulse occurs at

$$f_1 = \frac{1}{t_p}$$

This gives an immediate impression of the high-frequency content by identifying where this crossing occurs as a function of crest factor:  $f_1 = CF^2 \cdot prf$

Table 3-3 below shows the typical errors for various pulse waveforms as a function of input pulse frequency:

**Table 3-3** Typical errors for various pulse waveforms as a function of input pulse frequency

prf	Typical error for square wave, triangular wave, and pulse trains of CF=3, 5, or 10				
	Square wave	Triangle wave	CF=3	CF=5	CF=10
200	-0.02%	0.00%	-0.04%	-0.09%	-0.34%
1000	-0.07%	0.00%	-0.18%	-0.44%	-1.71%
2000	-0.14%	0.00%	-0.34%	-0.88%	-3.52%
5000	-0.34%	0.00%	-0.84%	-2.29%	-8.34%
10000	-0.68%	0.00%	-1.75%	-4.94%	-26.00%
20000	-1.28%	0.00%	-3.07%	-8.20%	-45.70%

**Table 3-3** Typical errors for various pulse waveforms as a function of input pulse frequency (continued)

prf	Typical error for square wave, triangular wave, and pulse trains of CF=3, 5, or 10				
	Square wave	Triangle wave	CF=3	CF=5	CF=10
50000	-3.41%	-0.04%	-6.75%	-32.0%	-65.30%
100000	-5.10%	-0.12%	-21.8%	-50.6%	-75.40%

The table above gives an additional error for each waveform, to be added to the value from the accuracy table provided in [Chapter 4](#), “Specifications”.

**Example:** A pulse train with level  $1 V_{\text{RMS}}$ , is measured on the 1 V range. It has pulse heights of 3 V (that is, a Crest Factor of 3) and duration 111  $\mu\text{s}$ . The prf can be calculated to be 1000 Hz, as follows:

$$prf = \frac{1}{CF^2 \times t_p}$$

Thus, from the table above, this AC waveform can be measured with 0.18 percent additional error.

### AC Filter

The multimeter’s AC voltage and AC current functions implement three low-frequency comb filters. These filters allow you to trade-off minimum measured frequency for faster reading speed. The “SLOW” mode filter notch at 2 Hz and useful for frequencies above 20 Hz. The “MEDIUM” filter notch at 20 Hz and useful for frequencies above 200 Hz. The “FAST” filter notch at 200 Hz and useful for frequencies above 1 kHz.

## Other Primary Measurement Functions

### Frequency measurement errors

The multimeter uses a reciprocal counting technique to measure frequency. This method generates constant measurement resolution for any input frequency. All frequency counters are susceptible to errors when measuring low-voltage, low-frequency signals. The effects of both internal noise and external noise pickup are critical when measuring “slow” signals. The error is inversely proportional to frequency. Measurement errors also occur if you attempt to measure the frequency of an input following a DC offset voltage change. You must allow the multimeter’s input to fully settle before making frequency measurements.

## DC current measurements

When you connect the multimeter in series with a test circuit to measure current, a measurement error is introduced. The error is caused by the multimeter's series burden voltage. A voltage is developed across the wiring resistance and current shunt resistance of the multimeter, as shown below.

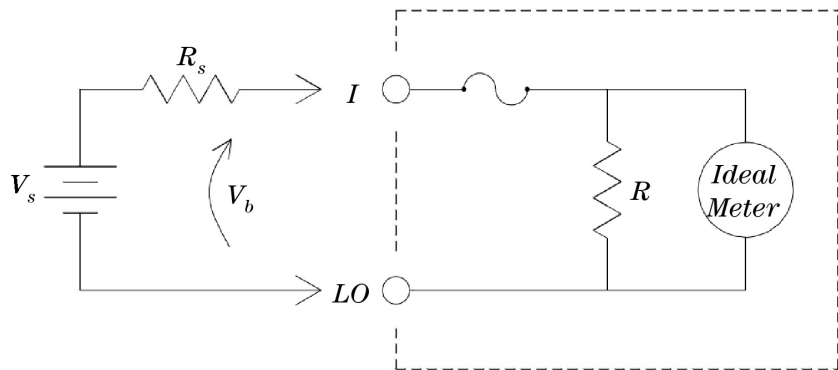

$V_s$  = Source Voltage  
 $R_s$  = DUT Source Resistance  
 $V_b$  = Multimeter Burden Voltage  
 $R$  = Multimeter Current Shunt

$$\text{Error (\%)} = \frac{-100\% \times V_b}{V_s}$$

**Figure 3-5** Wiring resistance and current shunt resistance

If you apply more than 5 A during current measurement, self-heating occurs in the multimeter's 10 A shunt resistor and internal signal-conditioning component. Do allow few minutes stabling time for better accuracy for current measurement. After applying more than 5 A current measurement, do allow a few minutes for heat dissipation to ensure better accuracy for other measurement.

## Capacitance measurements

The multimeter implements capacitance measurements by applying a known current to the capacitor as shown below:

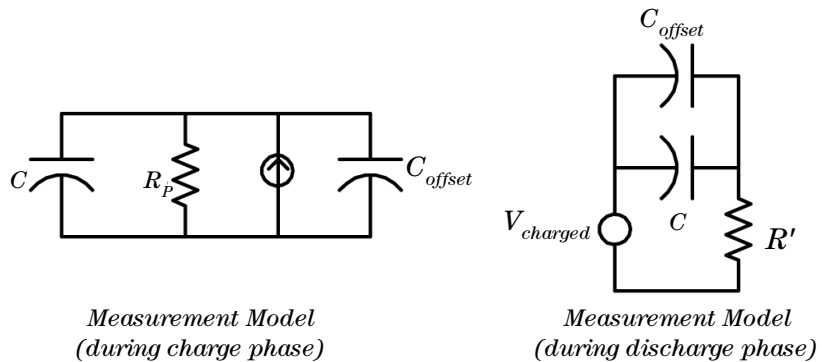

**Figure 3-6** Applying current to the capacitor

Capacitance is calculated by measuring the change in voltage ( $\Delta V$ ) that occurs over a “short aperture” time, ( $\Delta t$ ). The measurement cycle consists of two parts: a charge phase and a discharge phase.

The change in voltage ( $DV$ ) and “short aperture” time ( $Dt$ ), vary by range, in order to minimize noise and increase reading accuracy. The following table lists the current source and reading rate at full scale during the measurement.

Range	Current Source	Reading Rate at Full Scale
1 nF	100 nA	1.0/second
10 nF	100 nA	0.5/second
100 nF	1 $\mu$ A	1.5/second
1 $\mu$ F	1 $\mu$ A	0.25/second
10 $\mu$ F	10 $\mu$ A	0.25/second
100 $\mu$ F	100 $\mu$ A	0.25/second

Range	Current Source	Reading Rate at Full Scale
1 mF	500 $\mu$ A	0.25/second
10 mF	1 mA	0.15/second

The values of capacitance and loss resistance measured with the multimeter may differ from the values measured using an LCR meter. This is to be expected, since this is essentially a DC measurement method, while LCR measurement uses applied frequencies anywhere from 100 Hz to 100 kHz. In most cases, neither method measures the capacitor at its exact frequency of application.

For the best accuracy, take a zero null measurement with open probes, to null out the test lead capacitance, before connecting the probes across the capacitor to be measured.

## Temperature measurements

The multimeter measures temperature by measuring the temperature sensitive resistance of 5 k $\Omega$  thermistors.

Thermistors consist of semiconductor materials and provide roughly 10 times the sensitivity of an RTD. Because they are semiconductors, their temperature range is more limited, commonly to  $-80\text{ }^{\circ}\text{C}$  to  $150\text{ }^{\circ}\text{C}$ . Thermistors have highly non-linear, temperature-resistance relationships; therefore their conversion algorithms are more complex. Agilent multimeters use the standard Hart-Steinhart Approximation to provide accurate conversions.

## Other Sources of Measurement Error

### Loading Errors (AC volts)

In the AC voltage function, the input of the multimeter appears as a 1 MΩ resistance in parallel with 100 pF of capacitance. The cabling that you use to connect signals to the multimeter also adds capacitance and loading.

For low frequencies, the loading error is:

$$Error (\%) = \frac{-100 \times R_s}{R_s + 1 M\Omega}$$

At high frequencies, the additional loading error is:

$$Error (\%) = 100 \times \left[ \frac{1}{\sqrt{1 + (2 \pi \times F \times R_s \times C_{in})^2}} - 1 \right]$$

$R_s$  = Source Resistance

$F$  = Input Frequency

$C_{in}$  = Input Capacitance (100 pF) Plus Cable Capacitance

### Measurements Below Full Scale

You can make the most accurate AC measurements when the multimeter is at or near the full scale of the selected range. Autoranging occurs at 10% (down-range) and 120% (up-range) of full scale. This enables you to measure some inputs at full scale on one range and 10% of full scale on the next higher range. In general, the accuracy is better on the lower range; for the highest accuracy, select the lowest manual range possible for the measurement.

### High-Voltage Self-Heating Errors

If you apply more than 300 V<sub>rms</sub>, self-heating occurs in the multimeter's internal signal-conditioning components. These errors are included in the multimeter's specifications.

Temperature changes inside the multimeter due to self-heating may cause additional error on other AC voltage ranges.

### **AC Current Measurement Errors (Burden Voltage)**

Burden voltage errors, which apply to DC current, also apply to AC current measurements. However, the burden voltage for AC current is larger due to the multimeter's series inductance and your measurement connections. The burden voltage increases as the input frequency increases. Some circuits may oscillate when performing current measurements due to the multimeter's series inductance and your measurement connections.

### **Low-Level Measurement Errors**

When measuring AC voltages less than 100 mV, be aware that these measurements are especially susceptible to errors introduced by extraneous noise sources. An exposed test lead acts as an antenna and a properly functioning multimeter will measure the signals received. The entire measurement path, including the power line, acts as a loop antenna. Circulating currents in the loop create error voltages across any impedances in series with the multimeter's input. For this reason, you should apply low-level AC voltages to the multimeter through shielded cables. You should connect the shield to the input LO terminal.

Make sure the multimeter and the AC source are connected to the same electrical outlet whenever possible. You should also minimize the area of any ground loops that cannot be avoided. A high-impedance source is more susceptible to noise pickup than a low-impedance source. You can reduce the high-frequency impedance of a source by placing a capacitor in parallel with the multimeter's input terminals. You may have to experiment to determine the correct capacitor value for your application.

Most extraneous noise is not correlated with the input signal. You can determine the error as shown below.

$$\text{Voltage Measured} = \sqrt{V_{in}^2 + \text{Noise}^2}$$

Correlated noise, while rare, is especially detrimental. Correlated noise always adds directly to the input signal. Measuring a low-level signal with the same frequency as the local power line is a common situation that is prone to this error.

#### **Pulse Measurement Error**

You can use the DC measurement function to measure a pulse signal and obtain its relevant average measurement quickly. The formula of the equivalent DC average of a pulse signal is provided below.

$$\frac{1}{T} \int_T f(x) dx$$

where  $f(x)$  is the function representing the signal waveform over a period of  $T$ .

Errors may occur when the pulse signal is measured at low voltage range due to saturation of the multimeter's analog-to-digital (ADC) rail voltage.



## 4 Specifications

Test Considerations	100
DC Specifications	101
AC Specifications	103
Temperature and Capacitance Specifications	105
Operating Specifications	106
General Characteristics	112

This chapter describes the multimeter's specifications and operating specifications



## Test Considerations

These specifications apply when using the 34450A in an environment that is *free* of electromagnetic interference and electrostatic charge.

When using the multimeter in an environment where electromagnetic interference or significant electrostatic charge *is* present, measurement accuracy may be reduced.

Particularly note:

- The voltage measurement probes are not shielded and can act as antennas, causing electromagnetic interference to be added to the signal being measured.
- Electrostatic discharges of 4000 V or greater may cause the multimeter to temporarily stop responding, resulting in a lost or erroneous reading.

### NOTE

Specifications are subject to change without notice. For the latest specifications, go to the product page at [www.agilent.com/find/34450A](http://www.agilent.com/find/34450A)

---

## DC Specifications

Specifications are for 90 minutes warm-up time, slow mode, and operating temperature within 18 °C – 28 °C

**Table 4-1** DC accuracy ± (% of reading + % of range)

Function	Range <sup>[1]</sup>	Test Current or Burden Voltage	Input Impedance	1 Year 23 °C ± 5 °C	Temperature Coefficient 0 °C – 18 °C 28 °C – 55 °C
DC Voltage	100.000 mV	-	10 MΩ or > 10 GΩ	0.018 + 0.008	0.0020 + 0.0008
	1.00000 V	-	10 MΩ or > 10 GΩ	0.015 + 0.005	0.0015 + 0.0008
	10.0000 V	-	10 MΩ	0.015 + 0.005	0.0020 + 0.0008
	100.000 V	-	10 MΩ	0.015 + 0.005	0.0020 + 0.0008
	1000.00 V	-	10 MΩ	0.015 + 0.005	0.0020 + 0.0008
Resistance (2-wire) <sup>[2]</sup>	100.000 Ω	1 mA	-	0.050 + 0.008	0.0060 + 0.0008
	1.00000 kΩ	500 μA	-	0.050 + 0.008	0.0060 + 0.0005
	10.0000 kΩ	100 μA	-	0.050 + 0.005	0.0060 + 0.0005
	100.000 kΩ	10 μA	-	0.050 + 0.005	0.0060 + 0.0005
Resistance (4-wire) <sup>[2]</sup>	1.00000 MΩ	1 μA	-	0.060 + 0.005	0.0060 + 0.0005
	10.0000 MΩ	100 nA	-	0.250 + 0.005	0.0250 + 0.0005
	100.000 MΩ	100 nA/10 MΩ	-	2.000 + 0.005	0.3000 + 0.0005
DC Current	100.000 μA	< 0.02 V	-	0.05 + 0.015	0.007 + 0.0015
	1.00000 mA	< 0.2 V	-	0.05 + 0.007	0.007 + 0.0010
	10.0000 mA	< 0.02 V	-	0.05 + 0.015	0.008 + 0.0015
	100.000 mA	< 0.2 V	-	0.05 + 0.007	0.008 + 0.0010
	1.00000 A	< 0.2 V	-	0.10 + 0.015	0.012 + 0.0015
	10.0000 A	< 0.6 V	-	0.25 + 0.007	0.015 + 0.0010

## 4 Specifications

**Table 4-1** DC accuracy  $\pm$  (% of reading + % of range) (continued)

Function	Range <sup>[1]</sup>	Test Current or Burden Voltage	Input Impedance	1 Year 23 °C $\pm$ 5° C	Temperature Coefficient 0 °C – 18 °C 28 °C – 55 °C
Continuity <sup>[3]</sup>	1000 $\Omega$	0.5 mA	-	0.05 + 0.03	0.005 + 0.005
Diode Test <sup>[4]</sup>	1.0000 V	0.5 mA	-	0.05 + 0.03	0.005 + 0.005

[1] 20% over range on all ranges except 1000 VDC and 10 A range

[2] Specifications are for 4-wire  $\Omega$  or 2-wire  $\Omega$  using NULL function. If without NULL function, add 0.2  $\Omega$  additional error.

[3] Continuity thresholds is fixed at less than 10  $\Omega$

[4] Specifications are for the voltage measured at the input terminals only

## AC Specifications

Specifications are for 90 minutes warm-up time, slow mode, and operating temperature within 18 °C – 28 °C

**Table 4-2** AC accuracy ± (% of reading + % of range)

Function	Range <sup>[1]</sup>	Frequency	1 Year 23 °C ± 5 °C	Temperature Coefficient 0 °C – 18 °C 28 °C – 55 °C
True RMS AC Voltage <sup>[2]</sup>	100.000 mV	20 Hz – 45 Hz	1.0 + 0.1	0.02 + 0.02
		45 Hz – 10 kHz	0.2 + 0.1	0.02 + 0.02
		10 kHz – 30 kHz	1.5 + 0.3	0.05 + 0.02
		30 kHz – 100 kHz <sup>[3]</sup>	3.0 + 0.3	0.10 + 0.02
	1.00000 V to 750.00 V	20 Hz – 45 Hz	1.0 + 0.1 <sup>[4]</sup>	0.02 + 0.02
		45 Hz – 10 kHz	0.2 + 0.1	0.02 + 0.02
		10 kHz – 30 kHz	1.5 + 0.3	0.05 + 0.02
		30 kHz – 100 kHz <sup>[3]</sup>	3.0 + 0.3 <sup>[5]</sup>	0.10 + 0.02
True RMS AC Current <sup>[2]</sup>	10.0000 mA to 10.0000 A	20 Hz – 45 Hz	1.5 + 0.1	0.02 + 0.02
		45 Hz – 1 kHz	0.5 + 0.1	0.02 + 0.02
		1 kHz – 10 kHz <sup>[6]</sup>	2.0 + 0.2	0.02 + 0.02

[1] 20% over range on all ranges except ACV 750 V and ACI 10 A

[2] Specifications are for sine-wave inputs more than the 5% of range except 750 V range. Input signal must be more than 50 Vrms for 750 V range. Maximum crest factor of 3 at full scale. Input impedance is 1 MΩ in parallel with capacitance less than 120 pF, AC couple with up to 400 DCV

[3] Additional error to be added as frequency > 30 kHz and signal input < 10% of range. 30 kHz to 100 kHz: 0.003% of full scale per kHz

[4] For input < 200 V rms

[5] For input < 300 V rms

[6] Frequencies > 5 kHz are typical for all ranges

## 4 Specifications

**Table 4-3** Frequency accuracy  $\pm$  (% of reading + count)

Function	Range	Frequency	1 Year 23 °C $\pm$ 5 °C	Temperature Coefficient 0 °C to 18 °C 28 °C to 55 °C
Frequency	100.000 mV to 750.00 V <sup>[1]</sup>	20 Hz – 300 kHz <sup>[2]</sup>	0.02 + 3	0.005
	10.0000 mA to 10.0000 A	20 Hz – 10 kHz <sup>[3]</sup>	0.02 + 3	0.005

[1] The specifications are using an aperture of 1 second. The frequency can be measured up to 1 MHz as 0.5 V signal to 100 mV or 1 V ranges.

[2] 10% of range to full scale input on all ranges except where noted. 100 mV range specifications are for full scale or greater inputs. For inputs from 10 mV to 100 mV, multiply total % of reading error by 10

[3] 10% of range to full scale input on all ranges except where noted. 10 mA range specifications are for full scale or greater inputs. For inputs from 1 mA to 10 mA, multiply total % of reading error by 10

**Table 4-4** Frequency resolution

Function	Range	Frequency	Resolution
Frequency	100.000 mV to 750.00 V <sup>[1]</sup>	119.999 Hz	0.001 Hz
		1.19999 kHz	0.00001 kHz
		11.9999 kHz	0.0001 kHz
		119.999 kHz	0.001 kHz
		1.19999 MHz	0.00001 MHz

[1] The frequency can be measured up to 1 MHz as 0.5 V signal to 100 mV or 1 V ranges.

## Temperature and Capacitance Specifications

Specifications are for 90 minutes warm-up time, slow mode and operating temperature within 18 °C – 28 °C

**Table 4-5** Temperature and capacitance accuracy ± (% of reading + % of range)

Function	Range <sup>[1]</sup>	Probe Type or Test Current	1 Year 23 °C ± 5 °C	Temperature Coefficient 0 °C to 18 °C 28 °C to 55 °C
Temperature	–80.0 °C to 150 °C	5 kΩ thermistor probe	Probe accuracy +0.2 °C	0.002 °C
	–110.0 °F to 300.0 °F	5 kΩ thermistor probe	Probe accuracy +0.4 °F	0.0036 °F
Capacitance	1.000 nF	100 nA	-	-
	10.00 nF	100 nA	1 + 0.5	0.02 + 0.001
	100.0 nF	1.0 μA	1 + 0.5	0.02 + 0.001
	1.0000 μF	1.0 μA	1 + 0.5	0.02 + 0.001
	10.000 μF	10 μA	1 + 0.5	0.02 + 0.001
	100.00 μF	100 μA	1 + 0.5	0.02 + 0.001
	1000.0 μF	0.5 mA	1 + 0.5	0.02 + 0.001
	10,000 μF	1.0 mA	2 + 0.5	0.02 + 0.001

[1] 20% over range on all ranges

## Operating Specifications

**Table 4-6** Operating specifications on single display (approximate)

Function	Resolution	Function Change (sec) <sup>[1]</sup>	Range Change (sec) <sup>[2]</sup>	Auto Range (sec) <sup>[3]</sup>	Reading Rate /sec <sup>[4]</sup>		
					USB	GPIO	Serial
ACV	Slow (5.5)	2.6	2.5	4.6	1.9	1.9	1.9
	Med (4.5)	1.2	1.2	1.5	19	19	19
	Fast (4.5)	1.1	1.1	1.2	160	99	33
DCV	Slow (5.5)	1.3	1.3	1.6	1.7	1.7	1.7
	Med (4.5)	0.6	0.7	0.8	49	49	24
	Fast (4.5)	0.6	0.7	0.7	190	117	34
2-Wire $\Omega$	Slow (5.5)	1.2	1.3	1.6	1.4	1.4	1.4
	Med (4.5)	0.4	0.5	0.6	49	49	24
	Fast (4.5)	0.4	0.5	0.5	165	110	32
4-Wire $\Omega$	Slow (5.5)	1.2	1.4	1.9	1	1	1
	Med (4.5)	0.6	0.6	1.1	5.2	5.3	4.7
	Fast (4.5)	0.6	0.6	1	5.9	5.9	5.3
Frequency <sup>[5]</sup>	Slow (5.5)	2.1	2.1	2.6	0.9	0.9	0.9
	Med (4.5)	1.2	1.2	1.7	9	9	9
	Fast (4.5)	-	-	-	-	-	-
ACI	Slow (5.5)	2.6	2.6	6.2	1.9	1.9	1.9
	Med (4.5)	1.2	1.2	1.7	19	19	19
	Fast (4.5)	1.1	1.2	1.3	160	99	33
DCI	Slow (5.5)	1.3	1.3	1.9	1.7	1.7	1.7
	Med (4.5)	0.6	0.7	0.9	49	49	24
	Fast (4.5)	0.6	0.7	0.7	190	116	36

**Table 4-6** Operating specifications on single display (approximate) (continued)

Function	Resolution	Function Change (sec) <sup>[1]</sup>	Range Change (sec) <sup>[2]</sup>	Auto Range (sec) <sup>[3]</sup>	Reading Rate /sec <sup>[4]</sup>		
					USB	GPIB	Serial
Diode	4.5	0.1	-	-	190	117	38
Continuity	4.5	0.1	-	-	165	111	33
Temperature	4.5	0.5	-	-	4.2	4.2	3

[1] Time to change from 2-wire resistance to this specified function and to take at least one reading using SCPI "FUNC" and "READ?" commands

[2] Time to change from one range to the next higher range and to take at least one reading using SCPI "FUNC" and "READ?" commands

[3] Time to automatically change one range and to take at least one reading using SCPI "CONF AUTO" and "READ?" commands

[4] Number of measurements using SCPI "READ?" command when front panel display is off using "DISP OFF" command

[5] Reading rate depends on signal frequency  $\geq 20$  Hz

## Supplemental measurement specifications

**Table 4-7** Supplemental measurement specifications

---

### DC Voltage

- Measuring Method:
  - Sigma Delta A-to-D converter
- Input Resistance:
  - $>10\text{ G}\Omega \pm 2\%$  range (Selectable 100 mV, 1 V ranges)
  - $10\text{ M}\Omega \pm 2\%$  range (typical)
- Input Protection:
  - 1000 V on all ranges (HI terminal)

---

### Resistance

- Measurement Method:
  - 2-wire or 4-wire Ohms
- Open-Circuit Voltage
  - Limited to  $< 2.8\text{ V}$
- Input Protection:
  - 1000 V on all ranges (HI terminal)

---

### DC Current

- Shunt Resistance:
  - $1\ \Omega$  for 10 mA, 100 mA
  - $90\ \Omega$  for 100  $\mu\text{A}$ , 1 mA
  - $0.01\ \Omega$  for 1 A, 10 A
- Input Protection:
  - Externally accessible at Rear Panel 0.4 A, 500 V fuse for I terminal
  - Internal 11 A, 1000 V fuse for 10 A terminal

**Table 4-7** Supplemental measurement specifications (continued)**Continuity / Diode Test**

- Measurement Method:
    - Uses 0.5 mA  $\pm$  0.2% constant current source
  - Response Time:
    - Continuity : 165 samples/second with audible tone
    - Diode : 190 samples/second with audible tone
  - Continuity Threshold:
    - 10  $\Omega$  fixed
  - Input Protection:
    - 1000 V (HI terminal)
- 

**Temperature**

- Measurement Method:
    - 2-wire Ohms measurement of 5 k $\Omega$  thermistor sensor (YSI 4407) with computer conversion
    - Auto-ranging measurement, no manual range selection
  - Input Protection:
    - 1000 V (HI terminal)
- 

**Measurement Noise Rejection**

- CMR (Common Mode Rejection) for 1 k $\Omega$  unbalance LO lead
    - DC 140 dB
    - AC 70 dB
  - NMR (Normal Mode Rejection) for 60 Hz (50 Hz)  $\pm$  0.1%
    - Slow mode 5½ digits 90 dB
    - Medium mode 4½ digits 55 dB
    - Fast mode 4½ digits 0 dB
-

## 4 Specifications

**Table 4-7** Supplemental measurement specifications (continued)

---

### AC Voltage

- Measurement Method:
  - AC coupled true-RMS - measures the AC component with up to 400 VDC bias any range
- Crest Factor:
  - Maximum 3:1 at full scale
- Input Impedance:
  - $1\text{ M}\Omega \pm 2\%$  in parallel with  $< 100\text{ pF}$  of all ranges
- Input Protection:
  - 750 V rms on all ranges (HI terminal)

---

### AC Current

- Measurement Method:
  - DC coupled to the fuse and current shunt, AC coupled true rms measurement (measures the AC component only)
- Shunt Resistance:
  - $1\ \Omega$  for 10 mA, 100 mA
  - $0.01\ \Omega$  for 1 A, 10 A
- Input Protection:
  - Externally accessible at rear panel 0.4 A, 500 V fuse for I terminal
  - Internal 11 A, 1000 V fuse for 10 A terminal

---

### Frequency

- Measurement Method:
  - Reciprocal counting technique. AC coupled input using AC voltage function
- Signal Level:
  - 10% of range to full scale input on all ranges except where noted
  - Auto or manual range selection
- Gate Time:
  - 0.1 second or 1 period of the input signal

**Table 4-7** Supplemental measurement specifications (continued)

- Input Protection:
  - 750 V rms on all ranges (HI terminal)

**Math Functions**

- Null, dBm, dB, Min/Max/Avg, Hold, Limit Test
- 

**Data Log**

- Info, List, Histogram
- 

**Triggering and Memory**

- Samples per Trigger: 1 to 5,000 (typical) ,1 to 50,000 (optional)
  - Trigger Delay: 0 to 3600 sec (100  $\mu$ s step size)
- 

**Trigger Out**

- 3.3 V Logic output
  - Polarity: Negative pulse
  - Pulse width: Approximately 3  $\mu$ s
- 

**Non-Volatile Memory**

- 50,000 readings
- 

**Sample Timer**

- Range: Up to 3600 sec in 100  $\mu$ s steps
- 

**Remote Interface**

- USB 2.0 Standard, Serial (RS232), GPIB IEEE-488 (Optional)
- 

**Programming Language**

- SCPI-1994.0, IEEE-488.2
-

# General Characteristics

**Table 4-8** General characteristics

---

### Power Supply

- 100 V/120 V(127 V)/220 V(230 V)/240 V  $\pm$  10%
- AC line frequency 45 Hz – 66 Hz and (360 Hz – 440 Hz, 100/120 V operation)
- Automatically sensed at power-on

---

### Power Consumption

- 45 VA maximum, <11 W average

---

### Operating Environment

- Full accuracy at 0 °C to 55 °C
- Full accuracy to 80% RH at 30 °C (non-condensing)
- Altitude up to 3000 meters

---

### Storage Compliance

- –40 °C to 70 °C

---

### Safety Compliance

- IEC 61010-1:2001 / EN 61010-1:2001 (2nd Edition)
- Canada: CAN/CSA-C22.2 No. 61010–1–04
- USA: ANSI/UL std No. 61010-1:2004

---

### Measurement Category

- CAT II 300 V: CAT I 1000 Vdc, 750 Vac rms, 2500 Vpk transient over voltages
- Pollution degree 2

---

### EMC Compliance

- Certified to IEC61326-2-1: 2005 / EN61326-2-1:2006
  - CISPR 11:2003 / EN 55011:2007 Group 1 Class A
  - Canada: ICES/NMB-001:Issue 4, June 2006
  - Australia/New Zealand: AS/NZS CISPR 11:2004
-

**Table 4-8** General characteristics

---

**Shock and Vibration**

- Tested to IEC/EN 60086-2
- 

**Dimension (H×W×D)**

- Rack: 88.5 mm × 212.6 mm × 272.3 mm
  - Bench: 103.8 mm × 261.1 mm × 303.2 mm
- 

**Weight**

- 3.75 kg (8.27 lb.)
- 

**Warm-Up Time**

- 90 minutes
- 

**Warranty**

- 3 years
-

## To calculate total measurement error

The multimeter's accuracy specifications are expressed in the form:

( % of reading + % of range ). In addition to the reading error and range error, you may need to add additional errors for certain operating conditions. Check the list below to make sure you include all measurement errors for a given function. Also, make sure you apply the conditions as described in the footnotes on the specification pages.

- If you are operating the multimeter outside the temperature range specified, apply an additional temperature coefficient error.
- For AC voltage and AC current measurements, you may need to apply an additional low-frequency error or crest-factor error.

## Accuracy specifications

### Transfer Accuracy

Transfer accuracy refers to the error introduced by the multimeter due to noise and short-term drift. This error becomes apparent when comparing two nearly-equal signals for the purpose of “transferring” the known accuracy of one device to the other.

### 1-Year Accuracy

These long-term accuracy specifications are valid at the calibration temperature ( $T_{\text{cal}} \pm 5$  °C temperature range. These specifications include the initial calibration errors plus the multimeter’s long-term drift errors.

### Temperature Coefficients

Accuracy is usually specified at the calibration temperature ( $T_{\text{cal}} \pm 5$  °C temperature range. This is a common temperature range for many operating environments. You must add additional temperature coefficient errors to the accuracy specification if you are operating the multimeter outside the  $\pm 5$  °C temperature range (the specification is per °C).

## Configuring for highest accuracy measurements

The measurement configurations shown below assume that the multimeter is in its power-on or reset state. It is also assumed that auto-ranging is enabled to ensure proper full scale range selection.

- Select slow mode for 5½ digits.
- Null the test lead resistance for 2-wire ohms measurements, and remove any interconnection offset for DC voltage measurements.

**www.agilent.com**

### **Contact us**

To obtain service, warranty, or technical support assistance, contact us at the following phone numbers:

United States:

(tel) 800 829 4444 (fax) 800 829 4433

Canada:

(tel) 877 894 4414 (fax) 800 746 4866

China:

(tel) 800 810 0189 (fax) 800 820 2816

Europe:

(tel) 31 20 547 2111

Japan:

(tel) (81) 426 56 7832 (fax) (81) 426 567840

Korea:

(tel) (080) 769 0800 (fax) (080) 769 0900

Latin America:

(tel) (305) 269 7500

Taiwan:

(tel) 0800 047 866 (fax) 0800 286 331

Other Asia Pacific Countries:

(tel) (65) 6375 8100 (fax) (65) 6755 0042

Or visit Agilent World Wide Web at:  
[www.agilent.com/find/assist](http://www.agilent.com/find/assist)

Product specifications and descriptions in this document are subject to change without notice.

© Agilent Technologies, Inc. 2012–2013

Third Edition, July 21, 2013

34450-90000



**Agilent Technologies**