



Quad Input Pico

Wi-S4-Pico

4-channel Wi-Fi transmitter,
miniature



www.fif.com.pl/fox/quadinput



F&F Filipowski L.P.; Konstytucyjna 79/81, 95-200 Pabianice, POLAND
www.fif.com.pl; e-mail: biuro@fif.com.pl

System capabilities

- » Communication via home Wi-Fi network;
- » Remote access to devices via the Polish F&F cloud;
- » Integration with Google voice assistant and Google Home;
- » Autonomous operation, even without a Wi-Fi connection;
- » Advanced timers, local or based on online calendars, also with support for astronomical functions;
- » Convenient and free mobile app for Android and iOS systems.

Device properties

- » Support for 4 independent inputs, e.g., external momentary buttons;
- » Control of Fox receivers operating on the same local Wi-Fi network;
- » Ability to create advanced scenes linked to the press, release and long press of a button;
- » Each scene can simultaneously control up to 16 receivers;
- » Sequential control - successive button presses trigger other scenes;
- » Convenient configuration using the mobile app;
- » REST API and MQTT support for integration of pushbuttons with external systems (including Home Assistant);
- » Compact size: 35×36×19 mm;
- » Convenient installation in an installation box with a diameter of $\varnothing 60$ mm.



The device properties, configuration and application may change with updates to the device and application. The current version of the manual is available for download at: www.fif.com.pl/fox, product subpage.

Configuration

For the initial configuration of the Fox module, it is necessary to download and run the free Fox application available for mobile devices running the system:

- » Android, version 9.0 or higher*;
- » iOS, version 14 or higher*.



Requirements may change with the development of the mobile application and the requirements of the Google Play and AppStore shops.

You can download the app directly from the stores:



or via the website:

www.fif.com.pl/fox



On the above page, you can also find detailed information on how to configure and operate the devices and the Fox mobile app.

Wiring diagram

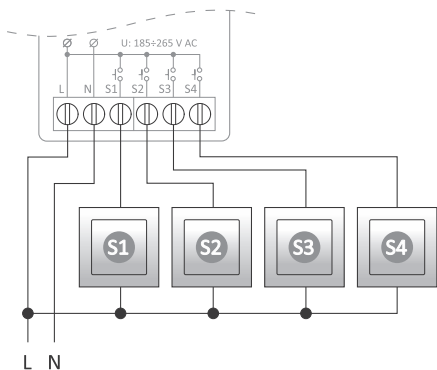

Fig. 1. Wiring diagram



The control inputs S1-S4 are triggered from the potential connected to L terminal of controller. (diagram above)



The use of monostable (momentary) buttons is recommended. If bi-stable buttons are used, at most one button can be connected to the input.



The Quad Input Pico controller is not suitable for use with illuminated buttons.

Terminals description

Function	Description
L	Power supply (phase wire)
N	Power supply (neutral wire)
S1	Button 1 input
S2	Button 2 input
S3	Button 3 input
S4	Button 4 input

First launch

Once you have connected your new device to the power supply, it is recommended that you carry out personalisation, i.e. linking it to your phone and user account. To do this, launch the Fox app, select the settings icon  at the bottom of the screen, select the Fox Wi-Fi system icon.

The QR code below provides instructions on how to create a new account in the Fox app:



Settings



SYSTEMS

 **Fox Wi-Fi** >
Total devices: 53

and then the **Add Device** command:

← Fox Wi-Fi

ADD DEVICE

 **Total devices: 53**



Fox controllers only support 2.4 GHz Wi-Fi connections. **It is not possible to connect the controller to a 5 GHz network!**



The first time you launch the app on your phone, follow the programme's instructions to create a user account or log in to an existing account, then select Fox Wi-Fi: **Search and configure wireless devices.**



Personalisation of the controller takes place via a direct connection. Due to the limited range of such a connection, it is recommended to carry out personalisation standing directly at the controller.

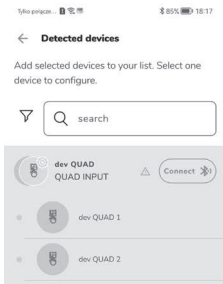

Fig. 2 List of detected devices

Once the search process is complete, new Fox devices will be displayed.

The **Quad Input Pico** module will appear in the list as follows (Fig. 2):

To add a new device, you must first connect to the device (press the **Connect** button - Fig. 2), and once connected, press the **Configure** button and continue following the application's instructions.

Buttons configuration

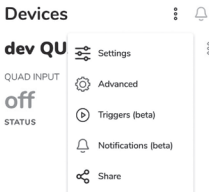

The configuration is carried out independently for each button. To do this, open the view of the selected pushbutton in the application (Fig.3), expand the menu (3 dots in the upper right part of the application) and select the **Triggers** command.

Note!

You must read and accept the credentials for the operation of the solution and its limitations.

Fig. 3 Button configuration menu

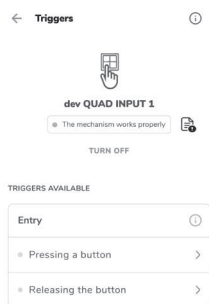

Fig. 4. Button action selection screen

- A window will now be displayed to configure the action to be performed after:
- » each short press of a button,
 - » each time the button is released,
 - » a long press of the button,
 - » another press of the button in sequential control).

To configure the action for the selected event, press the arrow symbol next to the action description.

← Pressing a button



In the next step, you need to add the devices controlled by the selected action. To do this, select the **Add Device** command and then select the relevant devices from the list.

Note!

Only devices operating within the same local Wi-Fi network are supported.

Fig. 5 Adding a device to the action



The long press time can be individually adjusted in the **Settings** menu (Fig. 3), parameter **Long press time**.



In the case of sequential control, each successive button press can trigger a different action. The actions are executed in sequence **Sequence 1 - Sequence 2 - Sequence 3**. The number of available sequences can be selected in the **Settings** menu (Fig. 3), parameter **Length of press sequence**. It is possible to set a maximum sequence of 6 steps.



Activating the **Reset Sequence** parameter in the settings (Fig. 3) will cause the next press of the button to start the **Sequence 1** step after the set period of inactivity has elapsed.



The actions for pressing and releasing the button are also executed when the sequential mode is set. This means that in this case, pressing and releasing the button will perform the action: **Button press - Sequence - Button release**.

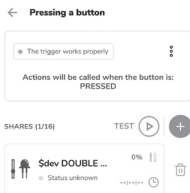

Once the device has been selected, the device action still needs to be configured (Fig. 6).

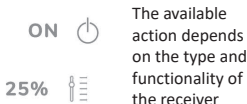

The available action depends on the type and functionality of the receiver

Duration of the order:

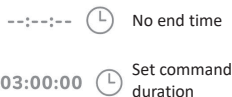

Fig. 6. Setting receiver action



Each step of adding/changing the configuration should be confirmed by pressing the **Save** button.

For each event, it is possible to add an action for 16 devices. Once the configuration is complete, it is recommended to check the correctness of the programme by pressing the **Test** button (Fig. 6).

A grey dot next to the device icon indicates that the button was not able to connect to the desired receiver.



In the event of errors, verify that the controlled receiver is powered up and on the same local network as the button.

LED signalling

The status of the module can be directly assessed by the **STATUS** LED located on the front of the device.



The grey color actually corresponds to the green LED and the black color to the red LED.



Controller
in factory mode

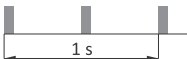

Connecting to
a Wi-Fi network

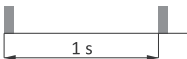

Connection to Wi-Fi
network established

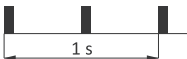

No connection
to Wi-Fi network



Restoring firmware

Fig. 7. Signalling

Restore factory settings

In case of lack of access to the controller, for example due to lost passwords, it is recommended that you reset the access passwords and then reconnect and configure the controller using the Fox application.

To reset passwords:

1. While the controller is operating, press and hold the **RESET** button. After pressing it, the **STATUS** indicator light will start blinking green.
2. Release the **RESET** button after approximately 5 seconds when the light goes out.
3. Press the **RESET** button briefly, the green **STATUS** light will come on again.
4. Press and hold down the **RESET** button. After approximately 3 seconds, the **STATUS** light will blink green. After a further 3 seconds it will go out and light up in red.
5. Release the button - after a few seconds the **STATUS** light will turn green and the controller will restart.
6. At the end of this procedure, all settings will be deleted, including access passwords and remote access parameters. You can now search for the device again in the application and personalise again.

Technical data

power supply	165÷265 V AC
control input	
inputs quantity	4
input type	digital
galvanic separation	none
control voltage	165÷265 V AC
control input current	<2 mA
power consumption	<1.2 W
communication	
radio frequency	2.4 GHz
transmission	Wi-Fi
radio power (IEEE 802.11n)	<20 dBm
receiver sensitivity	-98 dBm
terminal	2.5 mm ² screw terminals
tightening torque	0.4 Nm
working temperature	0÷45°C
humidity	<90%
(no condensation of steam and aggressive gases)	
dimensions	35×36×19 mm
mounting	in ø60 flush-mounted box
ingress protection	IP20

Warranty

F&F products are covered by a 24-month warranty from the date of purchase. The warranty is only valid with proof of purchase. Contact your dealer or contact us directly.

CE declaration

F&F Filipowski L.P. declares that the device is in conformity with the essential requirements of Directive 2014/53/EU of the European Parliament and of the Council of 16 April 2014 on the harmonisation of the laws of the Member States relating to the making available on the market of radio equipment and repealing Directive 1999/5/EC.

The CE Declaration of Conformity, along with the references to the standards in relation to which conformity is declared, can be found on www.fif.com.pl on the product page.