



Routing components for rigid protective conduits with IP40 and IP67 protection degree.

GENERAL INFORMATION

MECHANICAL AND FUNCTIONAL CHARACTERISTICS

Standard	EN 61386-1 (when applicable)	Conduits Ø (mm)	25
Type	Rigid conduit accessories	Operating temperature	-5 +60 °C
Description	Inspectable T	IP degree	IP40
Type of material	Halogen free in compliance with EN 50642	Glow Wire Test	750 °C
Colour	Grey RAL 7035		

DIMENSIONAL

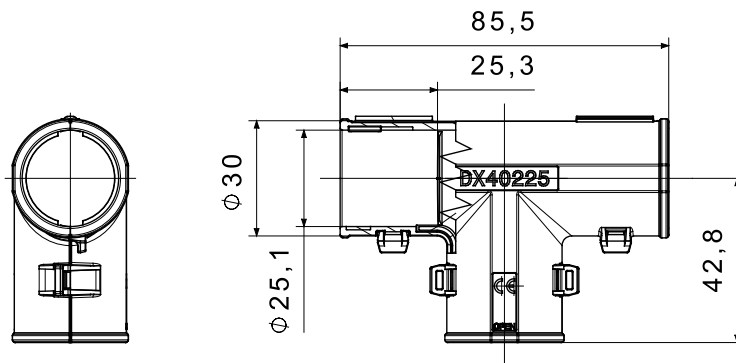

TECHNICAL SYMBOLOGY

INSTALLATION

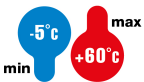

IP

IP40

HF
HALOGEN FREE

GWT

750 °C

STANDARDS/APPROVALS

