

EN



Movement by Perfection



The Royal League in ventilation, control and drive technology

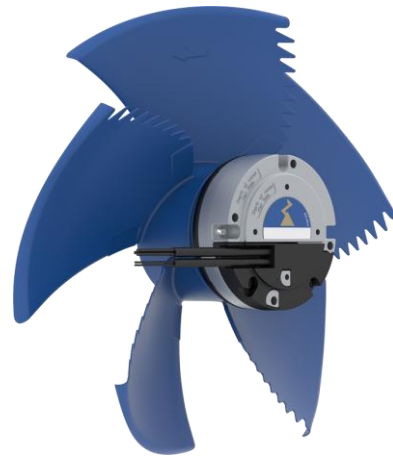

Product documentation

Type
FN025-4IA.Z8.V5P4

Article number
178109

Article number
178109

The Royal League

Die Königsklasse

Product documentation

ZIEHL-ABEGG Contact
Trembowelski, Tomasz / ZA Poland
Tomasz.Trembowelski@ziehl-abegg.pl

ZIEHL-ABEGG Subsidiary
Poland ZIEHL-ABEGG Polska Sp. z o.o.
ul. Wojska Polskiego 7
05-850 Macierzysz
POLAND
Phone + 48 22 351 707 0
Fax +48 22 665 01 34
www.ziehl-abegg.pl
biuro@ziehl-abegg.pl

Type
FN025-4IA.Z8.V5P4

Article number
178109

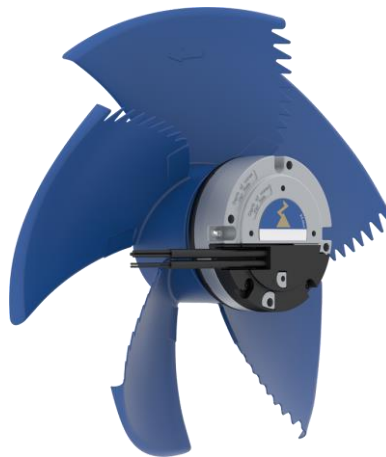

Table of Contents

1.	Recitals	4
2.	Product Specification - Technical Data	5
3.	Characteristic Curve	7
4.	Drawing	8
5.	Connection Diagram	9
6.	EU-Declaration of Conformity	10
7.	UKCA Declaration of Incorporation	12

1. Recitals

The Product Specifications contained in this document are final, unless otherwise stated by a separate provision in the "ZIEHL-ABEGG deviation list document" with respect to information provided by the customer (cp. separate Chapter: Attachment).

Other regulations between the parties, regardless of time, form or content, are not part of the subject matter of the contract and the agreement on characteristics/of features (Product Specifications) between the parties.

Compliance with the following specifications is mandatory to ensure the functionality and safety of the product. If the following specifications given especially but not limited for operating conditions, transport, storage, mounting, start-up, maintenance and repair are not observed, the product may not operate safely and may cause a hazard to the life and limb of users and third parties.

Deviations from the following requirements may therefore lead both to the loss of the statutory material defect liability rights and to the liability of the buyer for the product that has become unsafe due to the deviation from the specifications.

2. Product Specification - Technical Data

Article number	178109
Type key	FN025-4IA.Z8.V5P4
Designation	Axial fan with sickle blades
Fan design	without add-on parts.
Rated values	1~200-240V 50/60Hz P(1)140W 1.40-1.15A 3090 min ⁻¹ 50°C
Electrical connection	Integrated controller with variable cable 3x 0,82 mm ² and 4x 0,325 mm ² x 50 cm
Conformity	ErP 2015, ErP2026-Status: Incomplete fan (efficiency ready)
ErP Data	Measurement category ErP: A Air flow q(v) on Eta opt: 1198 m ³ /h Pressure increase p(fs) on Eta opt: 137 Pa Input power P(1) on Eta opt: 128 W Efficiency H(statA): 42.0 % Efficiency grade: N(actual) = 53.9 / N(target) = 40* *ErP 2015
Thermal class	THCL155
Type PFC integrated	no PFC
Painting motor	Fan unpainted
Material rotor	Steel
Painting rotor	Rotor 2 coat paint
Colour rotor	RAL 5002 (ultramarine blue)
Material blades/impeller	High Performance Composite Material
Painting impeller	Blades unpainted
Colour impeller	blue
Connection diagram	wiring diagram: 1360-404
Fitting position	H/Vu/Vo
Motor protection	integrated active temperature management
Type of protection	IP54
Impregnation	Moisture and hot climate protection
Quality of bearings	ball bearing with long-time lubrication
Labelling UL/CSA	E347018 ZB-155, MK055-0003
Colour motor	Fan unpainted.
Cable length	50 cm
Cable quality	PVC
Rating plate	1x fixed
Condens. drain holes	Condensation drain hole rotor open
Control	ECblue basic+ torque-regulated
Miscellaneous	
Number of blades	5
Blade setting	P
Number of conductor	3x 0,82 mm ² and 4x 0,325 mm ² x
VDE number	E912
Operating manual	L-BAL-F067

The Royal League

Die Königsklasse

Article number
178109

Weight

1.40 kg

Disclaimer CT20/DOE

Selected product is not governed by U.S. DOE and CT20 industrial fan and blower regulations.

*** Operation mode: Continuous operation with occasional starts (S1) according to DIN EN 60034-1:2011-02. Occasional starting between -30 °C and -25 °C is permissible. Continuous operation below -25 °C only with special bearings for refrigeration applications on request.

The Royal League

Die Königsklasse

Article number
178109

3. Characteristic Curve

1~200-240V 50Hz
type A according to ISO5801

Measured in full nozzle without guard grille in air flow direction V in installation

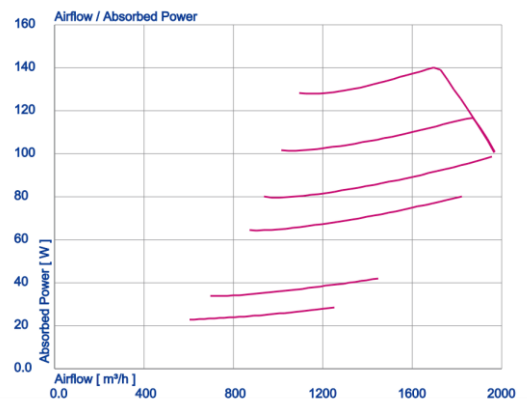
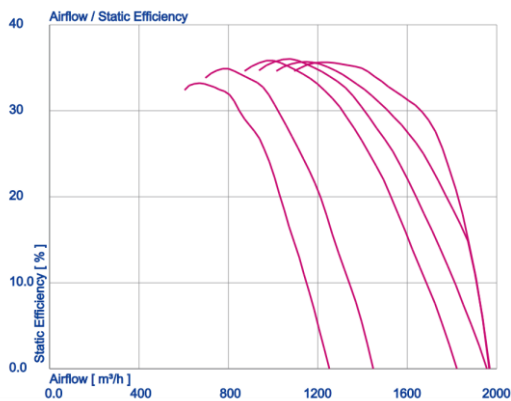
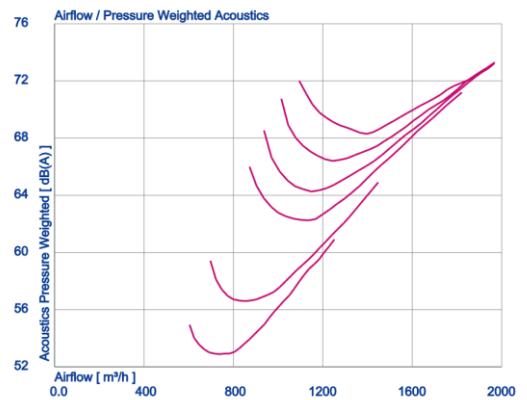
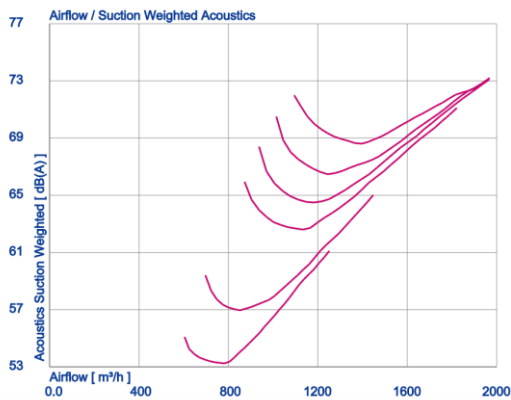
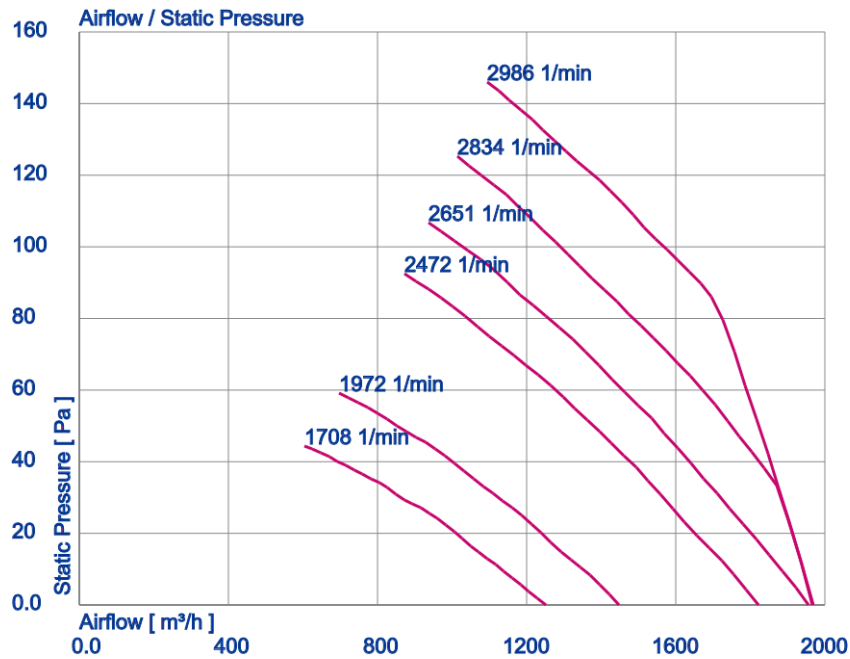

The Royal League Die Königsklasse

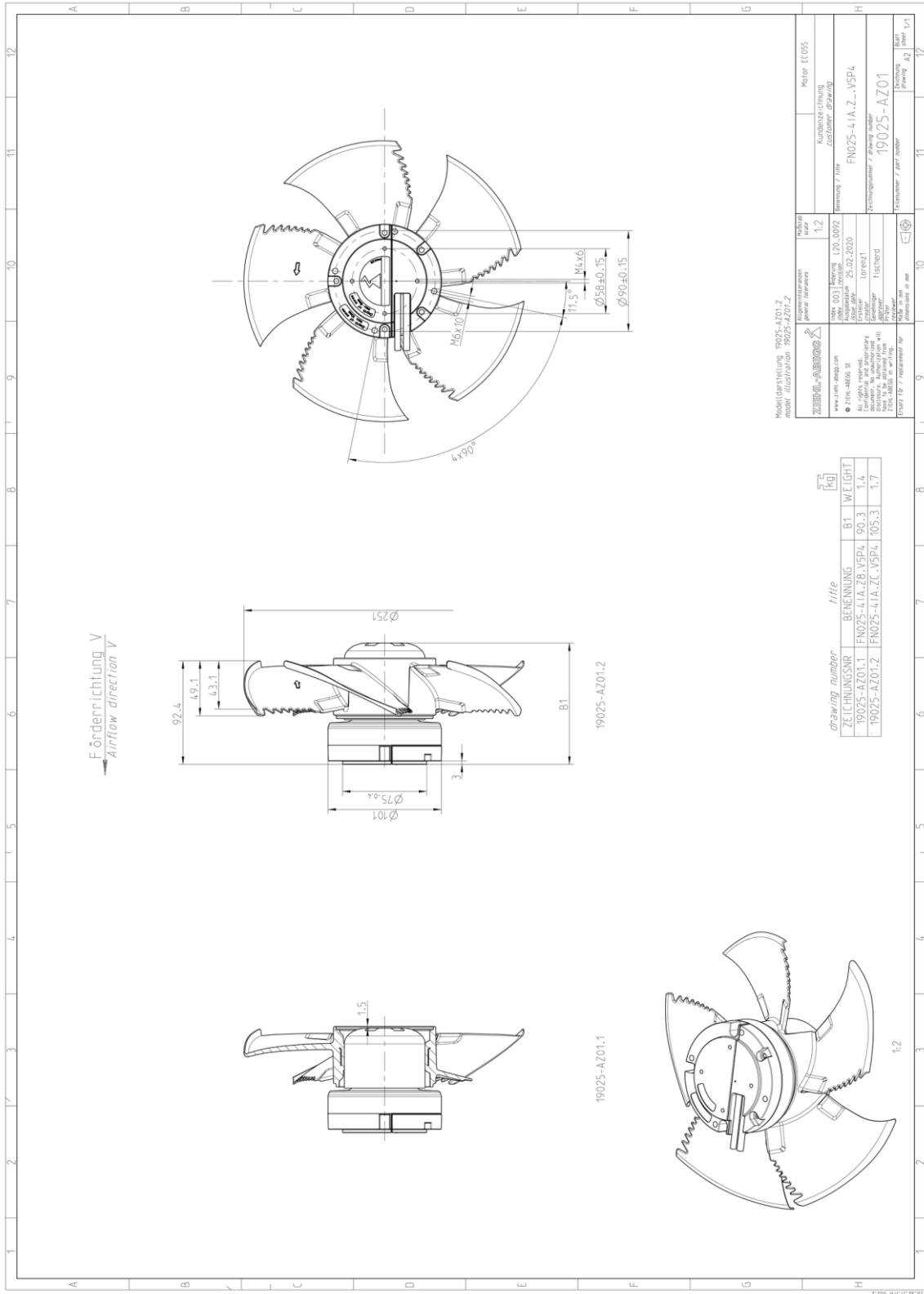

Dimensions in mm

The illustrations shown make no claim to completeness and are for orientation purposes only.

5. Connection Diagram

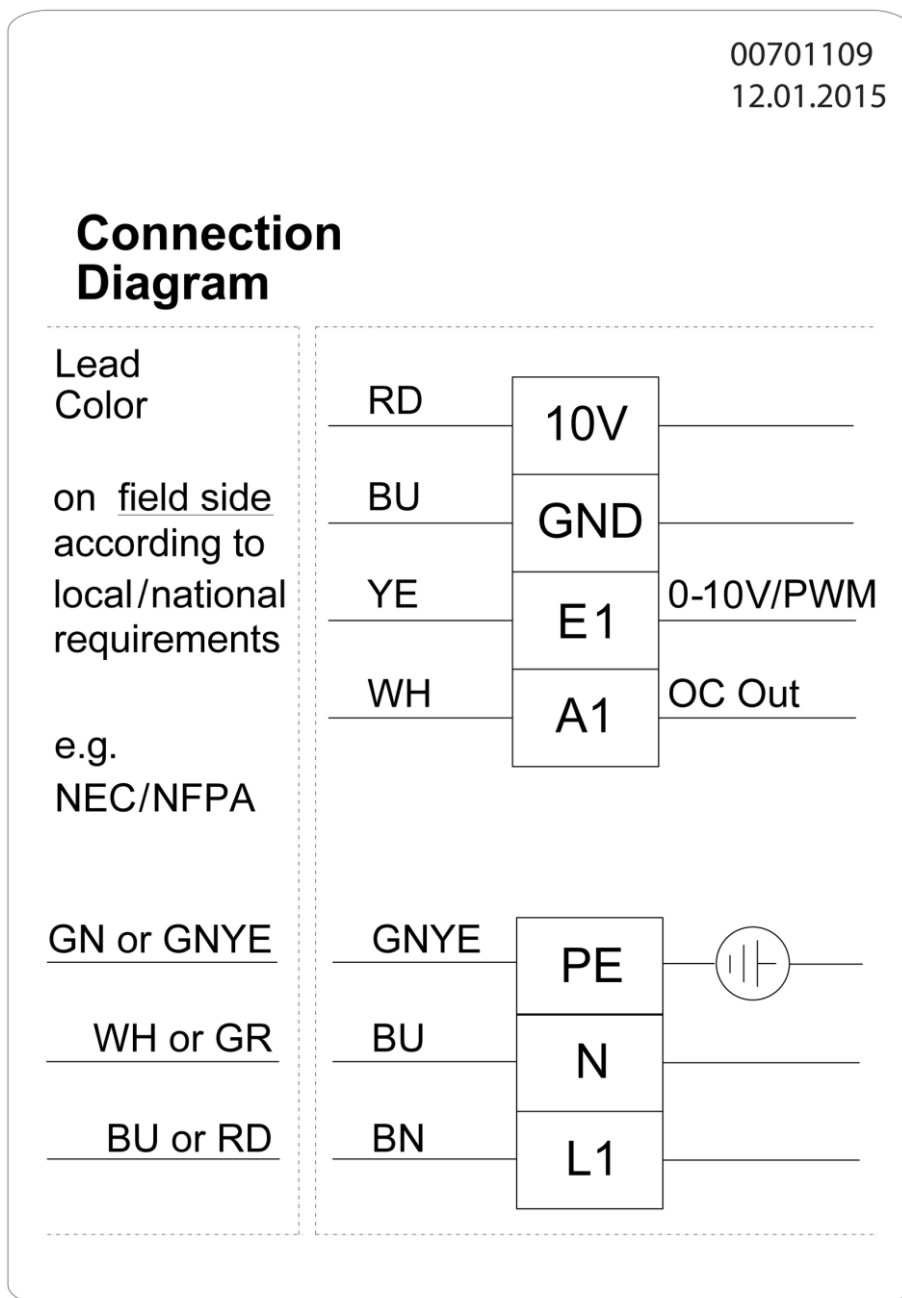

6. EU-Declaration of Conformity

EU declaration of conformity

- Translation -
(english)
ZA75-GB 2024/43 Index 020

Manufacturer: ZIEHL-ABEGG SE
Heinz-Ziehl-Straße
74653 Künzelsau
Germany

The manufacturer is solely responsible for issuance of the declaration of conformity.

The products:

- External rotor motor MK.., MW..
- Axial fan DN.., FA.., FB.., FC.., FE.., FF.., FG.., FH.., FL.., FN.., FP.., FS.., FT.., FV.., SG.., VN.., VR.., ZC.., ZF.., ZG.., ZN..
- Centrifugal fan ER.., GR.., HR.., RA.., RD.., RE.., RF.., RG.., RH.., RK.., RM.., RR.., RZ.., WR..

Motor type:

- Asynchronous internal or external rotor motor
- Asynchronous internal or external rotor motor with integrated frequency inverter
- Electronically commutated internal or external rotor motor
- Electronically commutated internal or external rotor motor with integrated EC controller

The above mentioned products of this declaration fulfil all relevant provisions of the following Directives of the Union:

- EMC Directive 2014/30/EU
- Low Voltage Directive 2014/35/EU
- ErP Directive 2009/125/EC, in conjunction with Regulation (EU) no. 327/2011

The following harmonized standards have been applied:

- EN 60034-1:2010 + AC:2010
- EN 60204-1:2018
- EN 60529:1991 + A1:2000 + A2:2013 + AC:1993 + AC:2016 + AC:2019
- EN 61000-6-2:2005 + AC:2005
- EN 61000-6-3:2007 + A1:2011 + AC:2012

The following additional standards were applied:

- EN IEC 61000-6-2:2019
- EN IEC 61000-6-3:2021

Compliance with the ErP Directive 2009/125/EC does not refer to external rotor motors MK.., MW..

All ErP-relevant information comprises measurements which are determined using a standardised measurement set-up. More details can be obtained from the manufacturer.

Compliance with the EMC Directive 2014/30/EU refers only to those products when they are connected by mounting / operating instructions. If these products are integrated into a system or supplemented with other components (e.g. sensing controls) and operated, the manufacturer or operator is responsible of the overall system for compliance with the EMC Directive 2014/30/EU.

Künzelsau, 22.10.2024
(Location, date of issue)

ZIEHL-ABEGG SE
Moritz Krämer
Director Product Development
Ventilation Technology
(name, function)



(signature)

ZIEHL-ABEGG SE
Jürgen Albig
Global President
Product Unit Ventilation
(name, function)



(signature)

ZIEHL-ABEGG 

EC Declaration of Incorporation

- Translation -
(english)
ZA87-GB 2024/43 Index 014

as defined by the EC Machinery Directive 2006/42/EC, Annex II B

The design of the partly completed machine:

- Axial fan DN..., FA..., FB..., FC..., FE..., FF..., FG..., FH..., FL..., FN..., FP..., FS..., FT..., FV..., SG..., VN..., VR..., ZC..., ZF..., ZG..., ZN...
- Centrifugal fan ER..., GR..., HR..., RA..., RD..., RE..., RF..., RG..., RH..., RK..., RM..., RR..., RZ..., WR...

Motor type:

- Asynchronous internal or external rotor motor
- Asynchronous internal or external rotor motor with integrated frequency inverter
- Electronically commutated internal or external rotor motor
- Electronically commutated internal or external rotor motor with integrated EC controller

Complies with the requirements in Appendix I, Articles 1.1.2, 1.1.5, 1.4.1, 1.5.1 in EC Machinery Directive 2006/42/EC.

The manufacturer is **ZIEHL-ABEGG SE**
Heinz-Ziehl-Straße
D-74653 Künzelsau

The following harmonized standards have been applied:

EN 60204-1:2018	Safety of machinery – Electrical equipment of machines – Part 1: General requirements
EN ISO 12100:2010	Safety of machinery – General principles for design – Risk assessment and risk reduction
EN ISO 13857:2019	Safety of machinery – Safety distances to prevent hazard zones being reached by upper and lower limbs
Note:	Compliance with EN ISO 13857:2019 relates only to the installed contact protection if it is part of the scope of delivery.

The special technical documents in accordance with Appendix VII B have been created and are available in full.

The following persons are authorized to compile the technical documents, address see above.

Upon reasonable request, the special documents shall be transmitted to the public authority. The transfer can be made electronically, on data carriers or on paper. All property rights remain with the aforementioned manufacturer.

Start-up of this incomplete machine is prohibited until it is ensured that the machine in which it has been installed complies with the provisions of the EC Machinery Directive.

Künzelsau, 22.10.2024
(Location, date of issue)

ZIEHL-ABEGG SE
Moritz Krämer
Director Product Development
Ventilation Technology
(name, function)

(signature)

ZIEHL-ABEGG SE
Jürgen Albig
Global President
Product Unit Ventilation
(name, function)

(signature)



7. UKCA Declaration of Incorporation

UK Declaration of Conformity

- Original -
(english)
ZA75_UK-GB
2024/43 Index 005

Manufacturer: ZIEHL-ABEGG SE
Heinz-Ziehl-Straße
74653 Künzelsau
Germany

The manufacturer is solely responsible for issuance of the declaration of conformity.

The products:

- External rotor motor MK., MW..
- Axial fan DN., FA., FB., FC., FE., FF., FG., FH., FL., FN., FP., FS., FT., FV., SG., VN., VR., ZC., ZF., ZG., ZN..
- Centrifugal fan ER., GR., HR., RA., RD., RE., RF., RG., RH., RK., RM., RR., RZ., WR..

The motor type:

- Asynchronous internal or external rotor motor
- Asynchronous internal or external rotor motor with integrated frequency inverter
- Electronically commutated internal or external rotor motor
- Electronically commutated internal or external rotor motor with integrated EC controller

These products comply with the following UK directives:

- Electromagnetic Compatibility Regulations 2016 No. 1091
- Electrical Equipment (Safety) Regulations 2016 No. 1101
- The Ecodesign for Energy-Related Products and Energy Information (Amendment) (EU Exit) Regulations 2019 No. 539

The following designated standards have been used:

- EN 60034-1:2010 + AC:2010
- EN 60204-1:2018
- EN 60529:1991 + A1:2000 + A2:2013 + AC:1993 + AC:2016 + AC:2019
- EN 61000-6-2:2005 + AC:2005
- EN 61000-6-3:2007 + A1:2011 + AC:2012

The following additional standards were applied:

- EN IEC 61000-6-2:2019
- EN IEC 61000-6-3:2021

Compliance with the Ecodesign for Energy-Related Products and Energy Information (Amendment) (EU Exit) Regulations 2019 does not refer to external rotor motors MK., MW..

All ERP-relevant information comprises measurements which are determined using a standardised measurement set-up. More details can be obtained from the manufacturer.

Compliance with the Electromagnetic Compatibility Regulations 2016 refers only to those products when they are connected by mounting / operating instructions. If these products are integrated into a system or supplemented with other components (e.g. sensing controls) and operated, the manufacturer or operator is responsible of the overall system for compliance with the Electromagnetic Compatibility Regulations 2016.

Künzelsau, 22.10.2024
(location, date of issue)

ZIEHL-ABEGG SE
Moritz Krämer
Director Product Development
Ventilation Technology
(name, function)



(signature)

ZIEHL-ABEGG SE
Jürgen Albig
Global President
Product Unit Ventilation
(name, function)



(signature)

ZIEHL-ABEGG 

UKCA Declaration of Incorporation

as defined by the Supply of Machinery (Safety) Regulations 2008
No. 1597, PART 2 / Annex II B

- Original -
(english)
ZA87_UK-GB
2022/17 Index 002

The design of the incomplete machine:

- Axial fan DN..., FA..., FB..., FC..., FE..., FF..., FG..., FH..., FL..., FN..., FP..., FS..., FT..., FV..., VN..., VR..., ZC..., ZF..., ZG..., ZN...
- Centrifugal fan ER..., GR..., HR..., RA..., RD..., RE..., RF..., RG..., RH..., RK..., RM..., RR..., RZ..., WR...
- Cross-flow fan QD..., QG..., QK..., QR..., QT...

The motor type:

- Asynchronous internal or external rotor motor (also with integrated frequency inverter)
- Electronically commutated internal or external rotor motor (also with integrated EC controller)

complies with the requirements in Annex I, Articles 1.1.2, 1.1.5, 1.4.1, 1.5.1 in Supply of Machinery (Safety) Regulations 2008 No. 1597.

The manufacturer is **ZIEHL-ABEGG SE**
Heinz-Ziehl-Straße
D-74653 Künzelsau

The following harmonised standards have been used:

EN 60204-1:2018	Safety of machinery; electrical equipment of machines; Part 1: General requirements
EN ISO 12100:2010	Safety of machinery - General principles for design - Risk assessment and risk reduction
EN ISO 13857:2019	Safety of machinery; safety distances to prevent danger zones being reached by the upper limbs
Note:	The maintenance of the EN ISO 13857:2019 relates only to the installed accidental contact protection, provided that it is part of the scope of delivery.

The specific technical documentation in accordance with Annex VII B has been written and is available in its entirety.

The following persons are authorized to compile the technical documents, address see above.

The specific documentation will be transmitted to the official authorities on justified request. The transmission can be electronic, on data carriers or on paper. All industrial property rights remain with the above-mentioned manufacturer.

It is prohibited to commission this incomplete machine until it has been secured that the machine into which it was incorporated complies with the stipulations of the Machinery (Safety) Regulations.

Künzelsau, 27.04.2022
(location, date of issue)

ZIEHL-ABEGG SE
Tobias Gauss
Deputy Head of Technics Ventilation Technology
(name, function)



(signature)

ZIEHL-ABEGG SE
Moritz Krämer
Head of Electrical Systems
(name, function)



(signature)

ZIEHL-ABEGG 



The Royal League in ventilation, **control** and drive technology

Intelligent control technology for any application

ZIEHL-ABEGG system capabilities:

Everything from a single source – perfectly matched for optimal performance

Please contact us. We would be pleased to design an individual solution for your requirements.

We would like to welcome you on our worldwide exhibitions. Please find our next exhibitions here.

[ZIEHL-ABEGG EVENTS](#)