

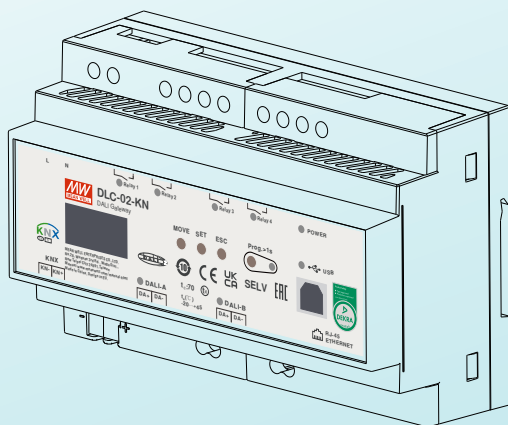

DLC-02-KN User Manual



KNX DALI Gateway



DLC-02-KN is a KNX to DALI gateway, used to connect a digital DALI lighting system to the KNX installation. Room-based lighting control is conveniently incorporated into the higher-level KNX system building management system. The device transforms switch and dim commands from the connected KNX system into DALI telegrams and status information from the DALI bus into KNX telegrams.

Contents

1.Safety Guidelines	1	5.DALI Commissioning	139
2.Overview	2	5.1 Menu	139
2.1 Overview Device	2	5.2 DALI Operation interface	140
2.2 Information at the ETS-Software	2	5.2.1 DALI Addressing and Parameter Download	141
2.3 Features	2	5.2.2 DALI Bus	144
2.4 Displays and operating elements	3	6. Communication Objects	151
2.5 Status LEDs	4	6.1 Summary and Usage	151
2.6 Mechanical specification	4		
3.Installation	5	7.Display	188
3.1 Operation process	5	7.1 Bus Info	189
3.2 Mounting	6	7.2 Test	189
3.3 Electrical Configuration	7	7.3 Add/Change	190
3.4 Wiring	8	7.4 System	193
3.5 ETS App (DCA)	8		
3.6 Parameter Configuration	10	8.Warranty	194
4.ETS Parameters	11	9.Environmental declaration information	194
4.1 General	11		
4.1.1 General setting	12		
4.1.2 DALI setting	14		
4.1.3 Relays enable	18		
4.1.4 Sequences enable	24		
4.1.5 Timer enable	28		
4.2 DALI A (B) Configuration	35		
4.2.1 A:ECGs enable	35		
4.2.2 A:Groups enable	77		
4.2.3 A:Broadcast enable	115		
4.2.4 A:HCL/Dim2Warm functions	118		
4.2.5 A:DT1 Rest/Inhibit functions	136		

1.Safety Guidelines

- Risk of fatal injury from electrical current, all work carried out on the unit may only be performed by skilled electricians. Observe the regulations valid in the country of use, as well as the valid KNX guidelines.
- Risk of electrical shock and energy hazard, all failure should be examined by a qualified technician. Please do not remove the case form the unit by yourself.
- Please do not install the unit in places with high moisture, high ambient temperature or under direct sunlight.

2.Overview

2.1 Overview Device

The manual refers to the following devices:

- DLC-02-KN: INPUT: 100 – 305Vac
- Model Encoding

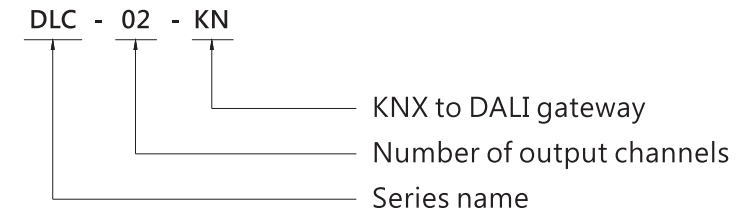

2.2 Information at the ETS-Software

Selection at the product database:

Manufacturer: MEANWELL Enterprise Co. Ltd.

Product family: Lighting

Product type: Gateway

Product name: DLC-02-KN

Order number: DLC-02-KN

2.3 Features

- Two independent DALI Bus channels with built-in DALI power supply (up to 250mA per bus)
- Connect up to 2 X 64 DALI ECGs
- Max 16 scenes and group setting per channel
- Up to 16 Sequence(32 Steps per Sequence)and 16 Timer(6 Operations per Timer)can be parameterized
- OLED display, LED indicators and button for local operation
- Built-in with 250V/5A X 4 relay
- Support DALI devices with part 202/206/207/208/209(DT1/DT5/DT6/DT7/DT8)
- Easy installation and configuration via ETS (database and DCA)
- Support for ETS5 or ETS6

Note: DLC-02-KN does not support DALI input device

2.4 Displays and operating elements

For detailed operation instructions of the OLED display, please refer to Chapter 7.

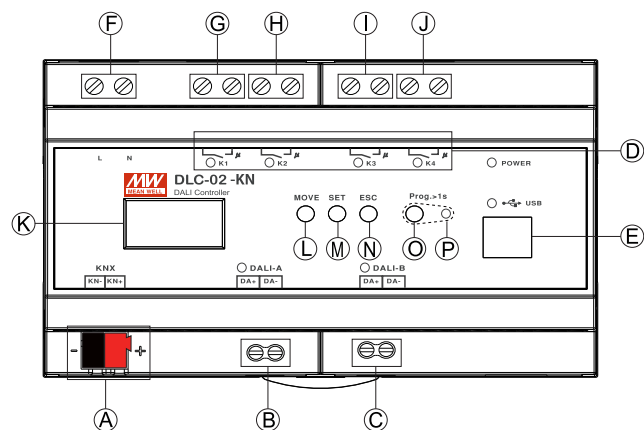

- (A) : KNX bus terminal
- (B) : DALI terminal A
- (C) : DALI terminal B
- (D) : Relay status LED
- (E) : USB connection(Type B)
- (F) : Mains connection
- (G) : Connections for the relay output K1
- (H) : Connections for the relay output K2
- (I) : Connections for the relay output K3
- (J) : Connections for the relay output K4
- (K) : Display
- (L) : Move button for the display
- (M) : Set button for the display
- (N) : Exit button for the display
- (O) : Programming button
- (P) : Programming LED

2.5 Status LEDs

LED Indicator	Status
POWER	<ul style="list-style-type: none"> ● Normal working ○ NOT connected to AC
K1, K2, K3, K4	<ul style="list-style-type: none"> ● Relay ON (short) ○ Relay OFF (open)
DALI-A, DALI-B	<ul style="list-style-type: none"> ● Bus voltage normal ○ NO bus voltage provided
USB	<ul style="list-style-type: none"> ● USB connected ○ NO USB detected
Programming LED	<ul style="list-style-type: none"> ● Programming mode ○ NOT in programming mode

2.6 Mechanical specification

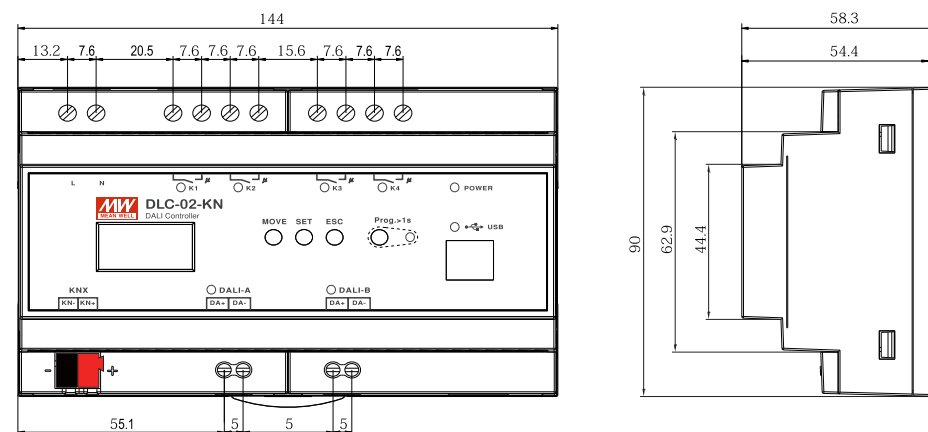

3. Installation

3.1 Operation process

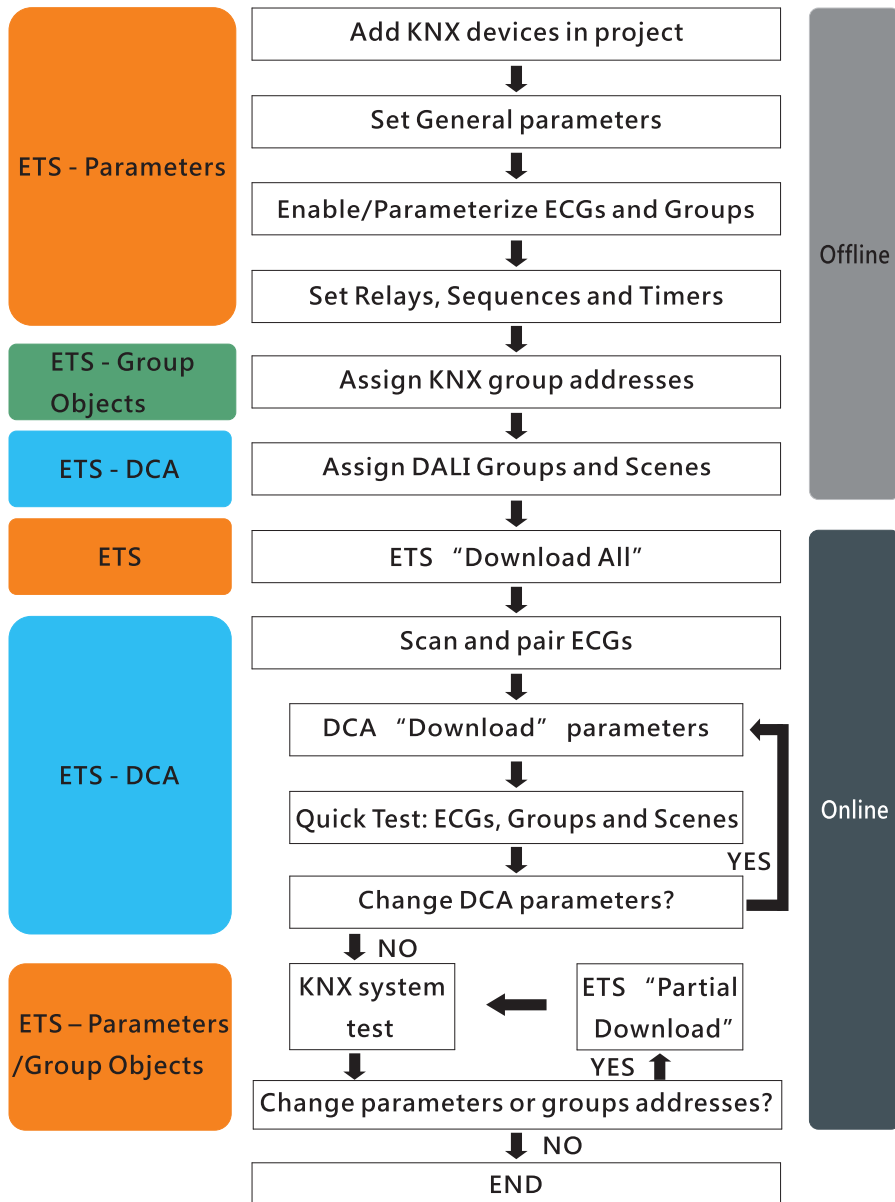

Note: (1).KNX ETS license is required to enable the DCA page of DLC-02-KN in ETS. If you need an ETS license, please contact KNX.

<https://my.knx.org/>

(2).For installation instructions on DCA, please refer to the 3.5 ETS APP (DCA).

3.2 Mounting

Mount as shown in figure only, with DALI terminals down or else sufficient cooling will not be possible.

Admissible DIN-rail: TS35/7.5 or TS35/15

For rail fastening:

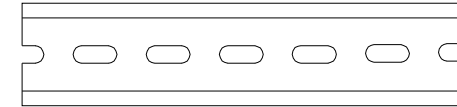

- (a) Tilt the unit slightly rearwards.
- (b) Fit the unit over top hat rail.
- (c) Slide it downward until it hits the stop.
- (d) Press against the bottom for locking.
- (e) Shake the unit slightly to check the locking action.

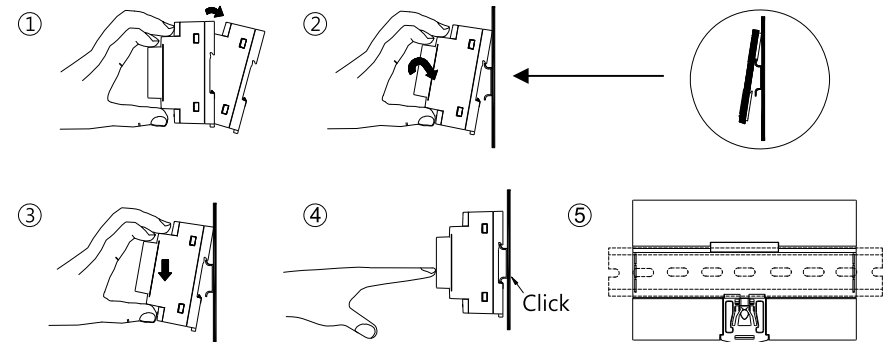

3.3 Electrical Configuration

DALI end

- The maximum number of ECGs connected is 64 per bus.
- The maximum length is 300m (with a cable cross-section of 1.5 mm²)

KNX end

- The maximum number of bus devices connected is 256.
- The maximum length of a line segment is 350 m, measured along the line between the power supply and the furthest bus device.
- The maximum distance between two bus devices cannot exceed 700 m.
- The maximum length of a bus line is 1000 m, keeping into account all segments

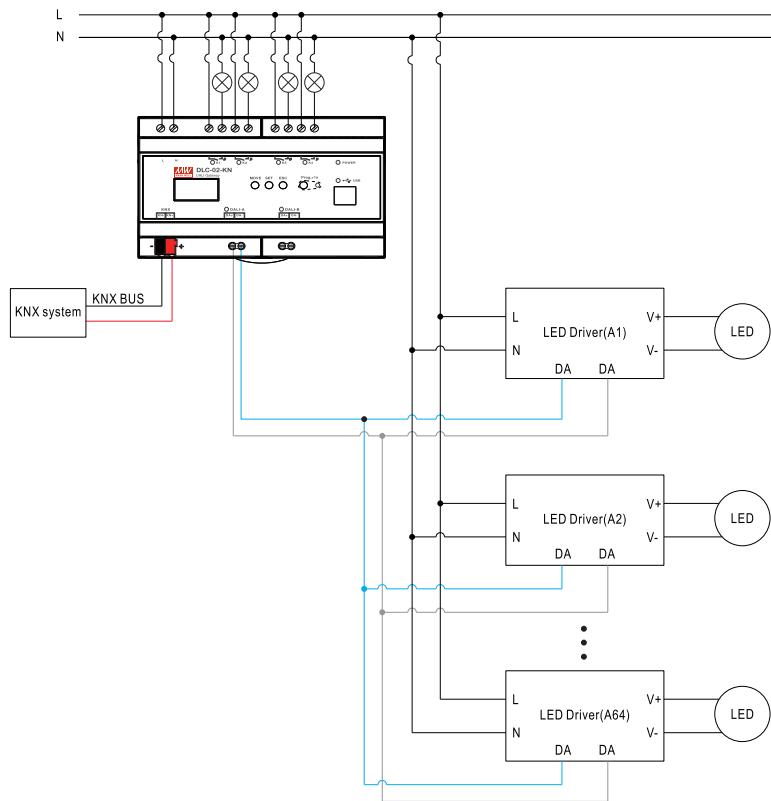

3.4 Wiring

- Use wires with an adequate cross-section.
- Use suitable mounting tools to do the wiring.

Type	AC and relay terminals L,N,K1,K2,K3,K4	DALI terminals (DALI-A, DALI-B)	KNX bus terminal (KNX)
Solid wire	0.5 ~ 4.0mm	0.5 ~ 1.45mm	0.6~0.8Φ
Stranded wire	0.5 ~ 2.5mm ²	0.5 ~ 1.5mm ²	-----
American wire gauge	12 ~ 26AWG	16 ~ 26AWG	20 ~ 22AWG
Wire stripping length	7 ~ 8mm (0.276" ~ 0.315")	7 ~ 8mm (0.276" ~ 0.315")	5mm (0.196")
Screwdriver	3mm Slotted	3mm Slotted	-----
Recommended tightening torque	5 kgf-cm (4.4 lb-in)	5 kgf-cm (4.4 lb-in)	-----

3.5 ETS App (DCA)

The application for the gateway is based on the standard interface for the configuration of communication objects and parameters as well as a special surface for configuring the DALI bus systems. This special interface is designed as a DCA (Device Control App) for the ETS. All required program data is automatically created when the App is imported.

DCA App installation steps are as follows:

- (1)Click the "Settings" button in the upper right corner of ETS, select "ETS Apps", and then select "+Install App".

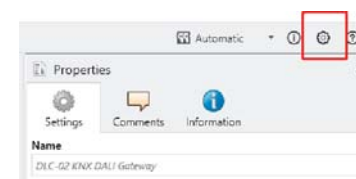

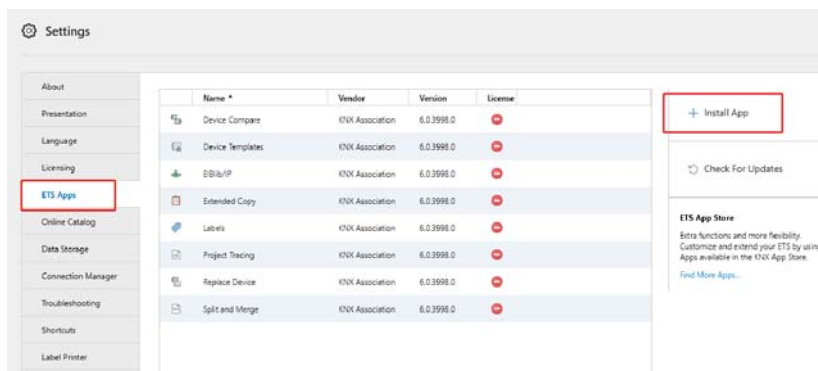

Note: 1. To install DCA App, ETS license is required.

2. If importing a knxproj file is required, please make sure that your ETS version is the same as the one exported the file. It is always best to update to the latest ETS version from the KNX Association for both of the ETS software to prevent compatibility issues between different versions.

(2) A file box will appear, select the ".ETS APP" file and import it.

Note: This ETS App file can be downloaded from the official MeanWell website or the link below:

https://building.meanwell.com/Upload/PDF/KNX_Application%20Database.pdf

Or download the ETS App file via MyKNX Shop for free.

<https://my.knx.org/en/shop/ets-apps>

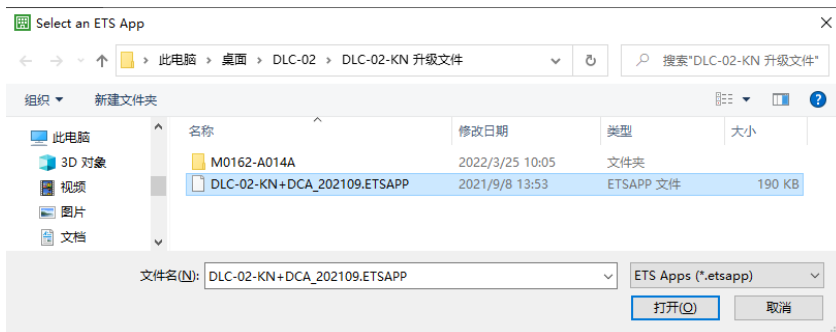

(3) After importing, the app will be displayed in the list of all ETS apps.

Note: Please always download the latest version of ETS App for a better experience.

Name	Vendor	Version	License
DLC-02-KN	MEAN WELL E...	3.0.0.0	[+]
Extended Copy	KNX Association	6.1.5686.0	[-]
Labels	KNX Association	6.1.5686.0	[-]
Device Templates	KNX Association	6.1.5686.0	[-]
Device Compare	KNX Association	6.1.5686.0	[-]
Project Tracing	KNX Association	6.1.5686.0	[-]
Replace Device	KNX Association	6.1.5686.0	[-]
Split and Merge	KNX Association	6.1.5686.0	[-]
EIBlib/IP	KNX Association	6.1.5686.0	[-]

(4) After restarting the ETS software, when selecting a product, an additional DCA tab will be displayed.

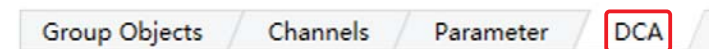

3.6 Parameter Configuration

The parameters and the corresponding group addresses can then be configured as with any other KNX product. The DALI specific configuration is performed in the DCA tab.

The actual DALI commissioning is only possible online, that means a connection to the device is necessary. In this step, all connected ECGs are searched and found and can then be assigned to a certain group. After this assignment has been carried out, this special DALI configuration must be loaded into the device. The "Download" button is available in the DCA tab, see 5. DALI Commissioning.

In the last step, the parameters and the links to the group addresses should be loaded into the device using normal ETS download. The device is now ready for operation.

4.ETS Parameters

The ETS parameters of the device are distributed across different parameter pages. To simplify the overview, only the parameter pages of the device selected in the function tree are displayed.

4.1 General

There are 5 parameter pages under "General", including General setting, DALI setting, Relays enable, Sequences enable, and Timers enable.

The parameters are described below:

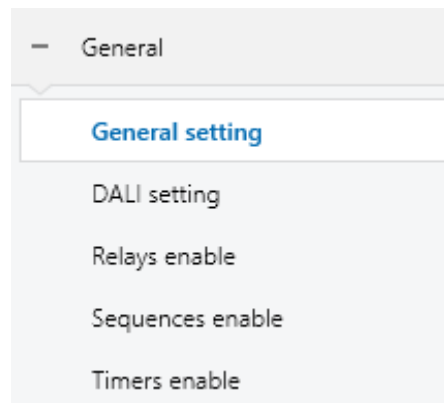

4.1.1 General setting

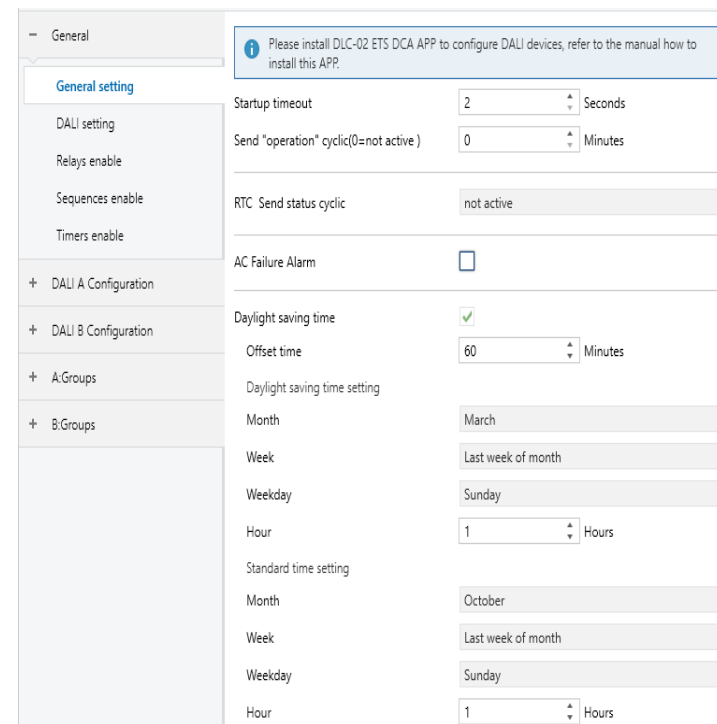

The chart shows the dynamic range for this parameter:

ETS-text	Dynamic range [default value]	Comment
Startup timeout	● 2-60s [2s]	After the KNX bus is powered on, all functions run after startup timeout finished. During the delay time, if there is Object Communication, it will be temporarily recorded and not responded. After the delay is over, perform the corresponding action.
Send "operation" cyclic(0=not active)	● 0-65535mins [0mins]	It is used to periodically report the status of devices and has an independent 'Operation' object.
RTC Send status cyclic(0=not active)	● not active /10s/20s/30s..	Sends status signals from the objects "RTC Time" and "RTC Date" at intervals you desire
AC Failure Alarm	● no check ● check	Activate or deactivate the "AC Failure Alarm" function

Daylight saving time	<ul style="list-style-type: none"> ●no check ●check 	Activate or deactivate the "Daylight saving time" function
The following parameters only appear when the "Daylight saving time" selection is set to "check"		
Offset time	<ul style="list-style-type: none"> ●30-180min [60min] 	Daylight/Winter Time offset time. At the beginning of daylight saving time, the current time is added with Offset time, and vice versa, the current time is subtracted with Offset time
Month	January~December [March]	The month in which daylight saving time begins.
Week	<ul style="list-style-type: none"> ●First week of month ●Second week of month ●Third week of month ●Fourth week of month ●Last week of month 	The week in which daylight saving time begins.
Weekday	<ul style="list-style-type: none"> ●Monday~Sunday [Sunday] 	The day in which daylight saving time begins. Note: If there is no 'Weekday' in the first week of the month, daylight saving time defaults to the 1st of the month.
Hour	<ul style="list-style-type: none"> ●0~23h [1h] 	The time in which daylight saving time begins.
Month	January~December [October]	The month in which winter time begins.
Week	<ul style="list-style-type: none"> ●First week of month ●Second week of month ●Third week of month ●Fourth week of month ●Last week of month 	The week in which winter time begins
Weekday	<ul style="list-style-type: none"> ●Monday~Sunday [Sunday] 	The day in which winter time begins Note: If there is no 'Weekday' in the first week of the month, winter time defaults to the 1st of the month
Hour	<ul style="list-style-type: none"> ●0~23h [1h] 	The time in which winter time begins

The following chart shows the objects that belong to General setting:

Num	Object name	Length	Description
47	[Central Function] operation	1 bit	When active, this object is use to send status of the device to the system at regular intervals which is set by the parameter "Send operation cyclic"
50	[Central Function] RTC	3 bytes	This object is used to set the time of DLC-02-KN, as well as read the time from DLC-02-KN
51	[Central Function] RTC	3 bytes	This object is used to set the date of DLC-02-KN, as well as read the date from DLC-02-KN.
52	[Central Function] AC Failure(Status)	1 bit	When the AC power of DLC-02-KN is disconnected, the object sends "1" and when the AC power supply of DLC-02-KN is normal, it sends "0"

4.1.2 DALI setting

The screenshot shows the DALI settings interface. The 'Behavior after KNX Bus power up' is set to 'defined value' with a value of '100%'. The 'Behavior after KNX Bus power down' is set to 'defined value' with a value of '0%(OFF)'. A warning message states: "If the current object 'Standby switch-off' is 'OFF', the 'Behavior after KNX Bus power down' will not have enough time to act." The 'Standby switch-off' is checked, with a delay time of 300 seconds. The delay time after switching back on is 1 second. A warning message states: "When using the Standby switch-off function, in case the lamp cannot be controlled when the relay module is powered down. Please set the power down of the relay associated with the object 'Standby switch-off' to 'ON'." Red annotations highlight the 'KNX failure' and 'Standby switch-off' sections.

4.1.2.1 DALI setting-KNX failure

Behavior after KNX Bus power up	defined value ▼
Value	100% ▼
Behavior after KNX Bus power down	defined value ▼
Value	0%(OFF) ▼

i If the current object "Standby switch-off" is "OFF", the "Behavior after KNX Bus power down" will not have enough time to act.

The chart shows the dynamic range for this parameter:

ETS-text	Dynamic range [default value]	Comment
Behavior after KNX Bus power up	<ul style="list-style-type: none"> ● switch-off value ● switch-on value ● no action ● defined value ● last value 	Uses this parameter to set the behaviors of the connected ECGs/lamps in DALI Bus A and B when KNX bus is on/ return. Actions are all off, all on, no action, all set to a certain value or all stay at last value.
Value	<ul style="list-style-type: none"> ● 0~100% [100%] 	This option is only available when "Behavior after KNX Bus power up" is selected as "defined value". Use this parameter to set a desired value
Behavior after KNX Bus power down	<ul style="list-style-type: none"> ● broadcast off ● broadcast on ● no action ● defined value 	Uses this parameter to set the behaviors of the connected ECGs/lamps in DALI Bus A and B when KNX bus voltage falls down. Actions are all off, all on, no action or all set to a certain value
Value	<ul style="list-style-type: none"> ● 100% ● 99% ... ● 0.8% ● 0.4% ● 0%(OFF) 	This option is only available when "Behavior after KNX Bus power down" is selected as "defined value". Use this parameter to set a desired value

4.1.2.2 DALI setting-Standby switch-off

The "Standby switch-off" function can save energy by switching off the AC power of all DALI drivers that are in standby on the Bus A or B. This function is used in conjunction with the KNX switch actuator (KAA-8R) to automatically turn on or off the AC power of the DALI drivers. All DALI drivers are connected to AC, and when the KNX bus is powered on, object 19 and object 42 "Standby switch-off" report "1". Determines whether all DALI drivers on bus A or B are in standby by polling. When all DALI drivers on bus A or B are in standby, the "Standby switch-off" function is triggered to turn off the AC of all DALI drivers on that bus. After polling once, it will automatically determine whether the "Standby switch-off" condition is satisfied according to the state of the KNX object "ECG on/off".

In addition, ECG adds the parameter "Be in control of standby switch off" to determine whether this DALI driver is a member of the standby shutdown function condition. For example, ECG 1 and ECG 2 enable "Be in control of standby switch off", while ECG 3 disables this parameter. If ECG 1 and ECG 2 are OFF, whether ECG 3 is ON or OFF, the object "Standby switch off" will send "0" to turn off the AC of ECG 1 and ECG 2.

Note: 1. During DCA debugging, the "Standby switch off" function is automatically disabled by default;
 2. When using the "Standby switch off" function, please set the parameter "Behavior after KNX Bus power down" of the relay associated with the object "Standby switch off" to "ON".

Standby switch-off

Delay time to switch-off Seconds

The delay time begins soon as all drivers are switched off

Delay time after switching back on Seconds

Delay time between switching on driver power supply and first DALI command

i When using the Standby switch-off function, in case the lamp cannot be controlled when the relay module is powered down. Please set the power down of the relay associated with the object "Standby switch-off" to "ON".

The chart shows the dynamic range for this parameter:

ETS-text	Dynamic range [default value]	Comment
Standby switch-off	<ul style="list-style-type: none"> ● no check ● check 	Activate or deactivate the "Standby switch-off" function
Delay time to switch-off	<ul style="list-style-type: none"> ● 10 ~65535s [300s] 	After the delay time, the DALI driver will disconnect the AC
Delay time after switching back on	<ul style="list-style-type: none"> ● 1~10s [1s] 	When the DALI driver is reconnected to AC power, the first DALI command will be received after this delay time

The following chart shows the objects that belong to Standby Switch-off:

Num	Object name	Length	Description
19	[DALI A] Standby Switch-off	1 bit	If 'Standby switch off' is set to 'check', then the object is enabled. This object sends "0" when the standby condition is satisfied, and "1" when the standby condition is released
20	[DALI A] Enable/Disable Standby Switch-off	1 bit	Enable or disable "Standby switchoff"function. When "Standby switchoff" is not enabled, object 19[DALI A] Standby Switch-off will send "1"

4.1.3 Relays enable

General ENABLE RELAY

General setting All Relays On/Off

Send status

DALI setting Send status cyclic(0=not active) Seconds

Relays enable Relay 1 control

Sequences enable Relay 2 control

Timers enable Relay 3 control

Relay 4 control

The chart shows the dynamic range for this parameter:

ETS-text	Dynamic range [default value]	Comment
All Relays On/Off	<ul style="list-style-type: none"> ● no check ● check 	Use this parameter to enable the function
Send status	<ul style="list-style-type: none"> ● no send,passive status ● at change ● always at input of telegram 	Sends status signals from the object "All Relays On/Off" with the option you selected. Note: The state is "Open" when all the relays are open, and the state is "Close" when at least one relay is closed.
Send status cyclic (0= not active)	<ul style="list-style-type: none"> ● 0~65535s [0s] 	Sends status signals from the object "All Relays On/Off" at intervals you desire
The above parameters only appear when the "ALL Relays On/Off" option is set to "check"		
Relay n control n=[1,4]	<ul style="list-style-type: none"> ● no check ● check 	Use this parameter to enable the function. For detailed information, please refer to section 4.1.3.1 "Relays"

The following chart shows the objects that belong to general setting:

Num	Object name	Length	Description
48	[Central Function] All Relays On/Off	1 bit	This object is use to switch all of the selected relays on /off. Note: The object is valid only when the following requirements are met. (1)The parameter "All Relays On/Off" and "Relay n(n=1~4) control"in "General setting" are checked (2)When "Relay n (n=1~4) control" is checked, there is a submenu called "Relays" in which the parameter "Central function" shall be checked
49	[Central Function] All Relays On/Off (Status)	1 bit	Sends the on/off status for the relays. 1: all of the selected relays are off. 0: one of the selected relays is on.

4.1.3.1 Relays enable-Relays

Once a relay is activated, a new page of Relays will appear. At this subpage, the further parameterization can be done. The following illustration shows the setting options at the submenu for a relay

Description

Output mode normally opened normally closed

On delay Seconds

Off delay Seconds

Central function

Send status

Send status cyclic(0=not active) Seconds

Additional inverted status

Behavior at locking

Behavior at unlocking

Priority/Forced control

Behavior after KNX Bus power up

Behavior after KNX Bus power down

Behavior after AC power on

The chart shows the dynamic range for this parameter:

ETS-text	Dynamic range [default value]	Comment
Description	----	Custom description Relay, maximum allowed of 30 bytes
Output mode	<input checked="" type="radio"/> normally opened <input checked="" type="radio"/> normally closed	Defines the default behavior of the relay
On delay	<input checked="" type="radio"/> 0~65535s [0s]	Adjustment of the time at which the switch-on process shall be delayed
Off delay	<input checked="" type="radio"/> 0~65535s [0s]	Adjustment of the time at which the switch-off process shall be delayed
Central function	<input checked="" type="radio"/> no check <input checked="" type="radio"/> check	Whether it is controllable via the object "[Central Function] All Relays On/Off"
Send status	<input checked="" type="radio"/> no send,passive status <input checked="" type="radio"/> at change <input checked="" type="radio"/> always at input of telegram	Sends status signals from the object "Relays On/Off" with the option you selected
Send status cyclic (0=not active)	<input checked="" type="radio"/> 0~65535s [0s]	Sends status signals from the object "Relays On/Off"at intervals you desire.
Additional inverted status	<input checked="" type="radio"/> no check <input checked="" type="radio"/> check	If actives, inverter signals received from the object "On/Off(Inverted Status)", that is 1→0; 0→1
Behavior at locking	<input checked="" type="radio"/> on <input checked="" type="radio"/> off <input checked="" type="radio"/> no change	Sets the action to be performed when a lock order is received. Note: Priority: Lock > Priority /Force control

Behavior at unlocking	<ul style="list-style-type: none"> ● on ● off ● no change ● previous state 	<p>Sets the action to be performed when an unlock order is received.</p> <p>Note: Priority: Lock > Priority /Force control.</p>
Priority/Forced control	<ul style="list-style-type: none"> ● no active ● off ● no change ● previous state 	<p>Activates or deactivates the function.</p> <p>Note: Priority: Lock > Priority /Force control</p>
Release time for forced control (0=not active)	<ul style="list-style-type: none"> ● 0~65535min [0min] 	<p>Set the delay time for releasing the forced control function. "0 min" means the function is not activated</p>
Behavior after forced status	<ul style="list-style-type: none"> ● on ● off ● no change ● previous state 	<p>Set the action to be performed when exiting the forced control</p>

Behavior after KNX Bus power up	<ul style="list-style-type: none"> ● on ● off ● no change 	<p>Set the action to be performed when the KNX bus is powered up</p>
Behavior after KNX Bus power down	<ul style="list-style-type: none"> ● on ● off ● no change 	<p>Set the action to be performed when the KNX bus is powered down</p>
Behavior after AC power on	<ul style="list-style-type: none"> ● on ● off ● previous state 	<p>Set the action to be performed when the AC of the DLC-02 is powered on.</p> <p>Note: It is considered as "AC power on" when the AC power is turned on again after 10 seconds of power off.</p>

The following chart shows the objects that belong to Relay:

Num	Object name	Length	Description
2517	[Relay 1]On/Off	1 bit	This object is used to switch the relay on or off.
2518	[Relay 1]Lock	1 bit	This object is used to lock/unlock the relay

2519	[Relay 1]On/Off (status)	1 bit	This object is used to send the status of the relay
2520	[Relay 1]On/Off (Inverted status)	1 bit	This object is used to send the inverted status of the relay. Note: This object is only valid when the parameter "Additional inverted state" is checked
2521	[Relay 1]Forced Control	2 bit	Forced control function 00 and 01: Deactivates Forced control 10: Sets to Forced control active with relay Off (open). 11: Sets to Forced control active with relay On (short). Note: Priority: Lock > Priority/ Force control
	[Relay 1]Priority	1 bit	Activates or deactivates forced On function. Relay On (short) when activated. Note: Priority: Lock > Priority/ Force control
	[Relay 1]Priority	1 bit	Activates or deactivates forced Off function. Relay Off (open) when activated. Note: Priority: Lock > Priority/ Force control
Please refer to Relay 1 above for the object description of Relay 2 to Relay 4 channels.			

4.1.4 Sequences enable

The 'Sequence enable' page is used to activate special effects functions. There are 16 independent sequence functions.

General	ENABLE SEQUENCE
General setting	Sequence 1 function <input checked="" type="checkbox"/>
	Description <input type="text"/>
DALI setting	Number of cycles(0 = not limited) <input type="text" value="1"/>
Relays enable	Reaction on stop via KNX <input checked="" type="radio"/> stop immediately <input type="radio"/> complete the cycle
Sequences enable	Sequence 2 function <input type="checkbox"/>
Timers enable	Sequence 3 function <input type="checkbox"/>
+ DALI A Configuration	Sequence 4 function <input type="checkbox"/>
+ DALI B Configuration	Sequence 5 function <input type="checkbox"/>
+ Sequences	Sequence 6 function <input type="checkbox"/>
	Sequence 7 function <input type="checkbox"/>
	Sequence 8 function <input type="checkbox"/>
	Sequence 9 function <input type="checkbox"/>
	Sequence 10 function <input type="checkbox"/>
	Sequence 11 function <input type="checkbox"/>
	Sequence 12 function <input type="checkbox"/>
	Sequence 13 function <input type="checkbox"/>
	Sequence 14 function <input type="checkbox"/>
	Sequence 15 function <input type="checkbox"/>
	Sequence 16 function <input type="checkbox"/>

The chart shows the dynamic range for this parameter:

ETS-text	Dynamic range [default value]	Comment
Sequence n function n=[1,16]	<input checked="" type="radio"/> no check <input checked="" type="radio"/> check	Use this parameter to activate the function
Description	----	Custom description sequence, maximum allowed of 30 bytes.
Number of cycles (0=not limited)	<input checked="" type="radio"/> 0-255 [1]	Use this parameter to set the number of times to execute the effect. If you choose "0", it means that the effect is executed in an infinite loop
Reaction on stop via KNX	<input checked="" type="radio"/> stop immediately <input checked="" type="radio"/> complete the cycle	Choose how to stop the sequence when a Seq.(n) "Stop" command is received
The above parameters only appear when the "Sequence n function" option is set to "check"		

Once a sequence function is activated, a new sequence interface will appear. In this sub page, further parameterization can be performed. The detailed information will be described in the next section.

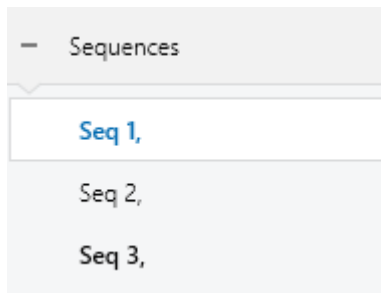

4.1.4.1 Sequences enable – Sequences



A sequence is essentially the process control of individual ECGs and different groups. In the Sequence subpage, you can set the brightness or colour of individual ECGs or groups. 32 steps can be programmed by an sequence function.

The "End" step means that it is executed after all the loops of the sequence are executed, Suppose that after executing all the loops of the Seq.1, you want to set the lamp to a certain brightness or colour, which can be set in the "End" Step.

General	Step	Bus ID	Lamp	Sub Lamp	Colour type	Colour value	White value	Brightness value	Fade time	Delay
General setting	1	none								
DALI setting	2	none								
Relays enable	3	none								
Sequences enable	4	none								
Timers enable	5	none								
	6	none								
+ DALI A Configuration	7	none								
+ DALI B Configuration	8	none								
	9	none								
- Sequences	10	none								
Seq 1	11	none								
Seq 2	12	none								
Seq 3	13	none								
	14	none								
	15	none								
	16	none								
	17	none								
	18	none								
	19	none								
	20	none								
	21	none								
	22	none								
	23	none								
	24	none								
	25	none								
	26	none								
	27	none								
	28	none								
	29	none								
	32	none								
	End	none								

The chart shows the dynamic range for this parameter:

ETS-text	Dynamic range [default value]	Comment
Bus ID	<ul style="list-style-type: none"> ● none ● DALI A ● DALI B ● RELAY 	Choose which bus to work with this sequence.
Lamp	<ul style="list-style-type: none"> ● ECG ● Group ● Broadcast ● Scene 	This option is only available when "Bus ID" is selected as "DALI A" or "DALI B". It is used to choose which ECG, group, broadcast or scene to work with this sequence.
Sub Lamp	<ul style="list-style-type: none"> ● ECG1~ECG64 ● G1~G16 ● S1~S16 ● Relay 1~Relay 4 	<ul style="list-style-type: none"> ● ECG 1~ECG 64: This option is only available when 'Lamp' is selected as 'ECG'. It is used to choose a certain lamp on the bus as the controlled part ● G1~G16: This option is only available when 'Lamp' is selected as 'Group'. It is used to choose a certain group on the bus as the controlled part ● S1~S16: This option is only available when 'Lamp' is selected as 'Scene'. It is used to choose a certain scene on the bus as the controlled part ● Relay 1~Relay 4: This option is only available when "Bus ID" is selected as "RELAY". It is used to choose a certain relay as the controlled part.
Colour type	<ul style="list-style-type: none"> ● none ● Tc ● RGB ● RGBW 	Set the colour type of the controlled part
When 'Colour type' is selected as 'Tc', there are the following parameters		

Colour Value	<ul style="list-style-type: none"> ● 1000-10000K [3000K] 	Used the parameter to set the colour temperature of the controlled part
When 'Colour type' is selected as 'RGB', there are the following parameters.		
Control Value	<ul style="list-style-type: none"> ● Colour selection 	Used the parameter to set the colour(RGB) of the controlled part
When 'Colour type' is selected as 'RGBW', there are the following parameters.		
Colour Value	<ul style="list-style-type: none"> ● Colour selection 	Used the parameter to set the colour(RGB) of the controlled part.
White Value	<ul style="list-style-type: none"> ● 0-255 [0] 	Used the parameter to set the white value of the controlled part.
Brightness value	<ul style="list-style-type: none"> ● no change ● 100% ● 99% ... ● 0.8% ● 0.4% ● 0%(OFF) 	Use this parameter to set a desired value. ● "no change": Use the previous brightness value.
Fade time	<ul style="list-style-type: none"> ● Immediately ● 0.7s ● 1.0s ● 1.4s ... ● 90.5s [2s] 	Defines the time needed to achieve the required setting
Delay	<ul style="list-style-type: none"> ● 0-65535 [0s] 	The duration of the effect (single step).

The following chart shows the objects that belong to Sequence:

Num	Object name	Length	Description
2537	[Seq 1]Start/Stop	1 bit	Activate or deactivates the Sequence 1. Note: This object is only valid when the parameter "Sequence 1" is checked
Please refer to Sequence 1 above for the object description of channels Sequence 2 to Sequence 16			

4.1.5 Timer enable

The 'Timer enable' page is used to activate the timer function.

<ul style="list-style-type: none"> General <ul style="list-style-type: none"> General setting DALI setting Relays enable Sequences enable Timers enable DALI A Configuration DALI B Configuration Sequences <ul style="list-style-type: none"> Seq 1, Timers <ul style="list-style-type: none"> Timer 1, Timer 2, 	<p>ENABLE TIMER</p> <p>Timer 1 function <input checked="" type="checkbox"/></p> <p>Timer 2 function <input checked="" type="checkbox"/></p> <p>Timer 3 function <input type="checkbox"/></p> <p>Timer 4 function <input type="checkbox"/></p> <p>Timer 5 function <input type="checkbox"/></p> <p>Timer 6 function <input type="checkbox"/></p> <p>Timer 7 function <input type="checkbox"/></p> <p>Timer 8 function <input type="checkbox"/></p> <p>Timer 9 function <input type="checkbox"/></p> <p>Timer 10 function <input type="checkbox"/></p> <p>Timer 11 function <input type="checkbox"/></p> <p>Timer 12 function <input type="checkbox"/></p> <p>Timer 13 function <input type="checkbox"/></p> <p>Timer 14 function <input type="checkbox"/></p> <p>Timer 15 function <input type="checkbox"/></p> <p>Timer 16 function <input type="checkbox"/></p>
---	--

The chart shows the dynamic range for this parameter:

ETS-text	Dynamic range [default value]	Comment
Timer n function n=[1,16]	<ul style="list-style-type: none"> no check check 	Use this parameter to activate the function. Up to 16 timers can be selected.

Once a timer is activated, a new page Timers will appear. At this subpage, the further parameterization can be done. Detailed information is described in the following section.

- Timers
 - Timer 1,
 - Timer 2,
 - Timer 3,

4.1.5.1 Timers enable – Timers



Timer function allows the lights to switch on at particular times of a day. Take an office application for example, lamps in group 1 of DALI bus A is used for the lobby, we can set a timer to switch on the lights in the lobby at a certain time on weekday morning before staff coming into work.

<ul style="list-style-type: none"> General <ul style="list-style-type: none"> General setting DALI setting Relays enable Sequences enable Timers enable DALI A Configuration DALI B Configuration Timers <ul style="list-style-type: none"> Timer 1, Timer 2, Timer 3, 	<p>Description</p> <p>Object-1 Type: Switch(DPT1.1001)</p> <p>Object-2 Type: Switch(DPT1.1001)</p> <p>Object-3 Type: Switch(DPT1.1001)</p> <p>Object-4 Type: Switch(DPT1.1001)</p> <hr/> <p>Timer operation 1 <input checked="" type="checkbox"/></p> <p>Hours: 0</p> <p>Minutes: 0</p> <p>Timer type selection: <input checked="" type="radio"/> Weekdays <input type="radio"/> Date</p> <p>Monday <input checked="" type="checkbox"/></p> <p>Thursday <input checked="" type="checkbox"/></p> <p>Wednesday <input checked="" type="checkbox"/></p> <p>Thursday <input checked="" type="checkbox"/></p> <p>Friday <input checked="" type="checkbox"/></p> <p>Saturday <input type="checkbox"/></p> <p>Sunday <input type="checkbox"/></p> <p>Sending Object-1 value <input type="checkbox"/></p> <p>Sending Object-2 value <input type="checkbox"/></p> <p>Sending Object-3 value <input type="checkbox"/></p> <p>Sending Object-4 value <input type="checkbox"/></p> <hr/> <p>Timer operation 2 <input type="checkbox"/></p> <hr/> <p>Timer operation 3 <input type="checkbox"/></p> <hr/> <p>Timer operation 4 <input type="checkbox"/></p> <hr/> <p>Timer operation 5 <input type="checkbox"/></p> <hr/> <p>Timer operation 6 <input type="checkbox"/></p>
--	--

The chart shows the dynamic range for this parameter:

ETS-text	Dynamic range [default value]	Comment
Description	----	Custom description Timer, maximum allowed of 30 bytes
Object-1 Type	<ul style="list-style-type: none"> ● switch (DPT1.001) ● Percentage (DPT5.001) ● Colour temperature (DPT7.600) ● RGB value (DPT232.600) ● RGBW value (DPT251.600) ● xy-coordinate value (DPT242.600) ● Scene number (DPT17.001) 	<p>Sets which object type is used to send status signals. Note: 1.A Timer has 4 optional objects. Users can choose the corresponding object type according to the ECG/lamp type.</p> <p>2.A timer has 6 optional Timer operations, Users can customize the timing time, and decide whether to activate the object to send data.</p>
Please refer to the above Object-1 Type for the parameters description of the Object-2 Type to Object-4 Type.		
The following parameters only appear when the "Timer operation n" option is set to "check". n=[1, 6].		
Timer operation n n=[1,6]	<ul style="list-style-type: none"> ● no check ● check 	Use this parameter to activate the function
Hours	<ul style="list-style-type: none"> ● 0-23 [0] 	Set a desired time in hours to trigger the timer
Minutes	<ul style="list-style-type: none"> ● 0-59 [0] 	Set a desired time in minutes to trigger the timer

The following parameters only appear when the 'Timer type selection' option is set to 'Weekdays'.		
Monday	<ul style="list-style-type: none"> ● no check ● check 	Whether to trigger the timer on Monday
Tuesday	<ul style="list-style-type: none"> ● no check ● check 	Whether to trigger the timer on Tuesday
Wednesday	<ul style="list-style-type: none"> ● no check ● check 	Whether to trigger the timer on Wednesday
Thursday	<ul style="list-style-type: none"> ● no check ● check 	Whether to trigger the timer on Thursday
Friday	<ul style="list-style-type: none"> ● no check ● check 	Whether to trigger the timer on Friday
Saturday	<ul style="list-style-type: none"> ● no check ● check 	Whether to trigger the timer on Saturday
Sunday	<ul style="list-style-type: none"> ● no check ● check 	Whether to trigger the timer on Sunday
Date	<ul style="list-style-type: none"> ● Calendar 	Select this date as the trigger time
Sending Object-1 value	<ul style="list-style-type: none"> ● no check ● check 	Whether to use Object-1 to send status signals when the timer is triggered
Switch value	<ul style="list-style-type: none"> ● off ● on 	Sets the on or off signal to be sent by the "1bit switch object" when the timer is triggered. [This option only exists when "Switch (DPT1.001)" in "Object-1 type" is chosen]

Percentage value	● 0-100% [0%]	Sets the dimming signal to be sent by the "1byte object percentage" when the timer is triggered. [This option only exists when "Percentage (DPT5.001)" in "Object-1 type" is chosen].
Colour temperature value	● 1000-10000K [3000K]	Sets the colour temperature signal to be sent by the "2byte object colour temperature" when the timer is triggered. [This option only exists when "Colour temperature (DPT7.600)" in "Object-1 type" is chosen].
Colour RGB value	● Colour selection 	Sets the RGB signal to be sent by the "3byte object colour RGB" when the timer is triggered. [This option only exists when "RGB (DPT232.600)" in "Object-1 type" is chosen]
Colour RGB value	● Colour selection 	Sets the RGB signal to be sent by the "6byte object colour RGBW" when the timer is triggered. [This option only exists when "RGBW (DPT251.600)" in "Object-1 type" is chosen]
Addition white value	● 0-255 [255]	Sets the white signal to be sent by the "6byte object colour RGBW" when the timer is triggered. [This option only exists when "RGBW(DPT251.600)" in "Object-1 type" is chosen]
Colour x-value (0..0.8)	● 0...0.8 [0.33]	Sets the x-value signal to be sent by the "6byte object colour xy-coordinate" when the timer is triggered. [This option only exists when "xy-coordinate (DPT242.600)" in "Object-1 type" is chosen]

Colour y-value (0..0.9)	● 0...0.9 [0.33]	Sets the y-value signal to be sent by the "6byte object colour xy-coordinate" when the timer is triggered. [This option only exists when "xy-coordinate (DPT242.600)" in "Object-1 type" is chosen].
Scene number	● 1-64 [1]	Sets the scene signal to be sent by the "6byte object colour xy-coordinate" when the timer is triggered. [This option only exists when "Scene number (DPT17.001)" in "Object-1 type" is chosen]

Note: 1. please refer to "Sending Object -1 value" above for parameter descriptions from Sending Object -2 value to Sending Object -4 value.
2. Please refer to "Timer operation 1" above for parameter descriptions from Timer operation 2 to Timer operation 6.

The following chart shows the objects that belong to Timer:

Num	Object name	Length	Description
2553	[Timer 1] Object-1 Switch	1 bit	This object is used to send on /off signals of the timer when it is triggered. This object only available when the parameter "Object-1 Type" chooses "Switch (DPT1.001)"
	[Timer 1] Object-1 Percentage	1 bit	This object is used to send dimming signals of the timer when it is triggered. This object only available when the parameter "Object-1 Type" chooses "Percentage(DPT5.001)"
	[Timer 1] Object-1 Colour Temperature	2bytes	This object is used to send colour temperature signals of the timer when it is triggered. This object only available when the parameter "Object-1 Type" chooses "Colour Temperature (DPT7.600)"
	[Timer 1] Object-1 Colour RGB	3bytes	This object is used to send RGB signals of the timer when it is triggered. This object only available when the parameter "Object-1 Type" chooses "Colour RGB (DPT232.600)".

Num	Object name	Length	Description
2553	[Timer 1] Object-1 Colour RGBW	6bytes	This object is used to send RGBW signals of the timer when it is triggered. This object only available when the parameter "Object-1 Type" chooses "Colour RGBW (DPT251.600)".
	[Timer 1] Object-1 Colour xy-coordinate	6bytes	This object is used to send xy-coordinate signals of the timer when it is triggered. This object only available when the parameter "Object-1 Type" chooses "Colour xy-coordinate (DPT242.600)".
	[Timer 1] Object-1 Scene Control	1 byte	This object is used to trigger scene of the timer when it is triggered. This object only available when the parameter "Object-1 Type" chooses "Scene Number(DPT17.001)"
<p>Note: 1. Please refer to Object 1 above for the description of [Timer 1] Object 2 to Object 4, .</p> <p>2. Please refer to Timer 1 above for the object description of channels Timer 2 to Timer 16</p>			

4.2 DALI A(B) Configuration

DALI A and DALI B are two independent DALI buses, and their parameters and functions are the same. The following chapters will take the DALI A bus as an example to explain its parameters and objects in detail

4.2.1 A:ECGs enable

"A: ECG enable" is used to activate ECG(1~64) on the DALI A bus

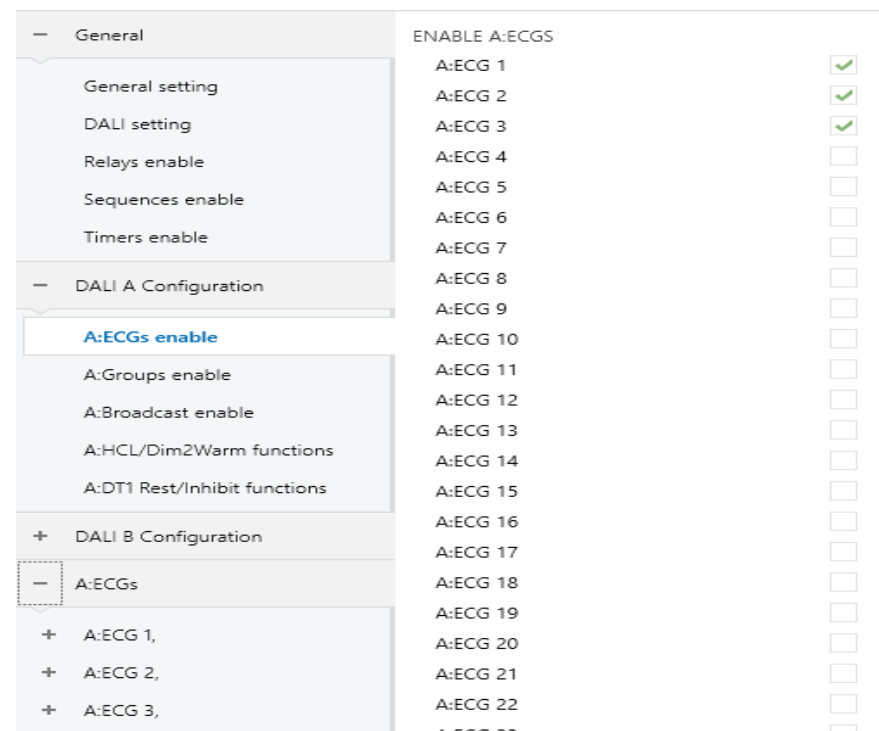

The chart shows the dynamic range for this parameter:

ETS-text	Dynamic range [default value]	Comment
A:ECG n n=[1,64]	<input type="radio"/> no check <input checked="" type="radio"/> check	Use this parameter to activate A: ECG n

Once an A: ECG is activated, a new A: ECG page will appear. In this sub page, further parameterization can be performed here. The detailed information will be described in the next section.



4.2.1.1 A:ECGs

The parameters of ECG can be set and modified through the left menu of A: ECGs, which includes the following sections: Dimming setting, Status, Function, Staircase light, and Colour control.

Note: 1. The "Staircase light" submenu only appears when "active" is selected for the parameter "Staircase light".

2. The "Colour control" submenu only appears when the parameter is selected as "Colour Control (DT8)".

The chart shows the dynamic range for this parameter:

ETS-text	Dynamic range [default value]	Comment
ECG Description	----	Custom description ECG, with a maximum length of 30 bytes
Group Assignment	<ul style="list-style-type: none"> ● Single ECG ● Group 1 ... ● Group 16 	This parameter is used to display information about the group to which the current ECG belongs (read-only)
Staircase Light	<ul style="list-style-type: none"> ● not active ● active 	Use this parameter to activate the staircase light function. Note: After activating the staircase light function, the Lock, Auto off, and Night mode functions will be disabled
ECG Device Type	<ul style="list-style-type: none"> ● Fluorescent Lamp(DT0) ● Self Contained Battery Lamp(DT1) ● Discharge Lamp (DT2) ● Low Voltage Halogen Lamp (DT3) ● Incandescent Lamp(DT4) ● 0..10V Converter (DT5) ● LED Module (DT6) ● Relay Module (DT7) ● Colour Control (DT8) 	Use this parameter to set the type of ECG used

Emergency Luminaire with Central Battery	<ul style="list-style-type: none"> ● No Emergency Luminaire ● Central Battery Emergency Luminaire 	Determine whether the current device is an emergency luminaire. Note: This parameter only appears when the "ECG Device Type" is not set to "Self Contained Battery Lamp"
The following parameters only appear when "Emergency Luminaire with Central Battery" is set to "Central Battery Emergency Luminaire"		
Value in Test Mode	<ul style="list-style-type: none"> ● 100% ● 99% ... ● 0.8% ● 0.4% ● 0%(OFF) [50%] 	This parameter is used to set the brightness value when Test Mode is turned on. Note: After entering Test Mode, the group and scene settings of the current ECG will be temporarily removed to avoid other control methods from changing its brightness value. After exiting Test Mode, the group and scene settings of the current ECG will be restored. Priority: Panic mode> Test mode> Lock> Night mode.
Duration of Test Mode	<ul style="list-style-type: none"> ● 5~240minutes [60min] 	This parameter is used to set the duration in Test Mode.
Behavior after Test Mode	<ul style="list-style-type: none"> ● switch-off value ● switch-on value ● no action ● last value 	This parameter is used to set the action after exiting Test Mode

The following chart shows the objects that belong to A:ECGs:

Num	Object name	Length	Description
8	[Dali A] Activate Test Mode	1 bit	Activate the test mode on the Dali A bus. When the parameter "Emergency Luminaire with Central Battery" in ECG is selected as "Central Battery Emergency Luminaire", the ECG responds to the test mode
59	[A:ECG 1] Staircase light	1 bit	When 'Staircase light' is selected as 'active', enable this object. Value of telegram: 1 = enable the staircase light function; 0 = If the parameter 'Manual switching off' is selected as 'active', the staircase light function can be turned off

● Self Contained Battery Lamp (DT1)

When the AC is interrupted, the battery lamp will quickly switch to the emergency mode, powered by the internal battery, and the brightness of the lamp in the emergency mode can be set to 0~100%. In addition, the DLC-02-KN can support automatic function test and automatic duration test of the battery lamp, as well as report the battery status of the lamp.

When "ECG Device Type" selects "Self Contained Battery Lamp (DT1)", the following special parameters will appear:

ETS-text	Dynamic range [default value]	Comment
Value in emergency mode*	<ul style="list-style-type: none"> ● 100% ● 99% ... ● 0.8% ● 0.4% ● 0%(OFF) [50%] 	Sets the brightness level of the lamp in emergency mode. Note: Priority: Emergency mode> Panic mode > Lock > Night mode

ETS-text	Dynamic range [default value]	Comment
Prolong time on recovery*	● 0-20min [0]	Sets the time to remain in the extended emergency mode after main voltage recovery
Function test interval*	● 0-255days [2]	Set the time interval for automatic function testing. Note: The functional testing interval is defined in days (1 to 255). After the end of each interval cycle, a functional test should be initiated. When the DTR value is 0, automatic function testing will be disabled
Duration test interval*	● 0-97weeks [2]	Set the time interval for the converter to perform automatic duration testing. Note: DURATION TEST INTERVAL is defined in weeks(1 to 97). After the end of each interval cycle, the duration test should begin, and automatic duration testing will be disabled when the DTR value is 0.
Test execution time*	● 0-255days [7]	Sets the maximum time after which the function test or duration test must be executed. If a test has not ended within this time the result will indicate max delay exceeded.

object" Activate Rest Mode"	● no check ● check	Set whether the current ECG activates Rest Mode
object" Activate Inhibit Mode"	● no check ● check	Set whether the current ECG activates Inhibit Mode

*Note:1. The above parameters are only reset after downloading the database, and will not be reset when KNX power is restored.

2.Priority:Emergency mode (mains = off) > Function test / Duration test / Inhibit mode / Rest mode / Extended emergency mode > Panic mode > Lock > Normal operation.

"Normal operation" includes "Auto off / Standby switch-off / Night mode / Staircase/ Sequence/ Timer / HCL".

The following chart shows the objects that belong to A:ECGs:

Num	Object name	Length	Description
64	[A:ECG 1] Converter Test Control	1 byte	This object is used to start duration test of the converter, function tests and battery status queries. Furthermore, it allows to stop running test and to reset test flags. These object follows the following coding: Bit 0: Reserved. Bit 1: Start function test Bit 2: Start duration test Bit 3: Start partial duration test Bit 4: Stop test Bit 5: Reset function test done flag Bit 6: Reset duration test done flag Bit 7 – 255: Reserved

Num	Object name	Length	Description
65	[A:ECG 1] Converter Status	2 bytes	<p>Converter Mode. This object is used to send the status of a converter with the following coding: Bit 0: Unknown. Bit 1: Normal mode active. Bit 2: Inhibit mode active: for 15 minutes the converter will not switch the emergency lighting on when a power failure occurring. Bit 3: Hardwired inhibit mode active: digital input that the converter can have to activate the inhibit mode. Bit 4: Rest mode active: forced off emergency lighting during emergency mode. Bit 5: Emergency mode active. Bit 6: Extended emergency mode active. Bit 7: FT in progress. Bit 8: DT in progress. Bit 9: PDT in progress. Bit 10 - 15: Reserved. HS: Hardware status. Bit0: Hard connection suppression activation. Bit1: The hard wire switch has been turned on. Bit2, Bit3: Reserved. Equal to 0. FP: Functional testing to be determined. 0: Unknown. 1: No test waiting.</p>

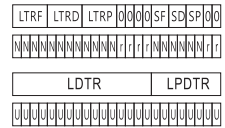
Num	Object name	Length	Description
			<p>2: Test waiting. 3: Reserved. DP: Continuous testing to be determined. 0: Unknown. 1: No test waiting. 2: Test waiting. 3: Reserved. PP: Partial duration testing to be determined. 0: Unknown. 1: No test waiting. 2: Test waiting. 3: Reserved. CF: Frequency converter failure. Indicates that one or more faults have been detected. More information about the types of faults can be found in CTR. 0: Unknown. 1: No fault detected. 2: Fault detected. 3: Reserved.</p>
66	[A:ECG 1] Converter Test Result	6 bytes	 <p>This object is used to send the result of the last converter test with the following coding: LTRF, LTRD, LTRP: Last Test Result Function/Duration/ Partial duration: Indicates the test result of each type: Bit 0: Unknown. Bit 1: Passed in time. Bit 2: Passed max delay</p>

Num	Object name	Length	Description
			<p>exceeded. Bit 3: Failed, test executed in time. Bit 4: Failed, max delay exceeded. Bit 5: Test manually stopped. Bit 6 - 15: Reserved. SF, SD, SP: Start method of last Function/ Duration/Partial test. Indicates the method by which the last test started. Updated when a test is finish. Bit 0: Unknown. Bit 1: Started automatically. Bit 2: Started by Gateway. Bit 3: Reserved. LDTR: Last Duration Test Result. Contains the battery discharge time as the result of the last successful duration test indicated in minutes. LPDTR: Last Partial Duration Test Result. Provides the remaining battery charge level after the last partial duration test. bit 0: Deep discharge point. Bit 1 - 253: Battery level. Bit 254: Fully charged. Bit 255: Unknown.</p>

●0...10V Converter (DT5)

DLC-02-KN can support 0-10Vdc or 1-10Vdc signal converters, and can set the output voltage curve as a logarithmic or linear curve

When "ECG Device Type" is selected as "0... 10V Converter (DT5)", the following special parameters will appear:

ETS-text	Dynamic range [default value]	Comment
Output range	<ul style="list-style-type: none"> ● 1-10V ● 0-10V 	Set the output voltage range of the signal converter
Internal pull-up	<ul style="list-style-type: none"> ● switch-on ● switch-off 	Set whether the output voltage channel of the signal converter is connected to the pull-up resistor
Dimming curve	<ul style="list-style-type: none"> ● log ● linear 	Select the output curve type of the signal converter

●LED Module (DT6)

When "ECG Device Type" selects "LED Module (DT6)", the parameters will appear, and log dimming curve or linear dimming curve can be selected

ETS-text	Dynamic range [default value]	Comment
Dimming curve	<ul style="list-style-type: none"> ● log ● linear 	Set the dimming curve of the ECG. Note: The parameters are only reset after downloading the database, and will not be reset when KNX power is restored.

● Relay Module (DT7)

When "ECG Device Type" selects "Relay Module (DT7)" the following special parameters will appear:

ETS-text	Dynamic range [default value]	Comment
Up switch-on threshold	● 1-255 [1]	In the up state, sets the threshold for turning on the relay. "255" means invalid
Up switch-off threshold	● 0-255 [255]	In the up state, sets the threshold for turning off the relay. "255" means invalid.
Down switch-on threshold	● 1-255 [255]	In the down state, sets the threshold for turning on the relay. "255" means invalid.
Down switch-off threshold	● 0-255 [255]	In the down state, sets the threshold for turning off the relay. "255" means invalid.

4.2.1.1.1 A:ECG – Dimming setting

The screenshot shows the following settings for 'A:ECG 1':

- Value on DALI System Failure: defined value
- Value: 100%
- Value on ECG Power On: defined value
- Value: 0%(OFF)
- Switch-on value: last on value defined value
- Value: 100%
- Switch-off value: 0%(OFF)
- Switch-on fade time: 2.0s
- Switch-off fade time: 2.0s
- Relative dimming fade time: 4.0s
- Absolute dimming fade time: 4.0s
- Enable switch OFF via relative dimming:
- Minimum dimming value: 0%(OFF)
- Maximum dimming value: 100%

The chart shows the dynamic range for this parameter:

ETS-text	Dynamic range [default value]	Comment
Value on DALI System Failure	● switch-off value ● switch-on value ● last value ● defined value	Uses this parameter to set the behaviors of the ECG when DALI bus voltage falls down. Actions are off, on, last value or set to a certain value
Value	● 100% ● 99% ... ● 0.8% ● 0.4% ● 0%(OFF)	Use this parameter to set a desired value.
Value on ECG Power On	● switch-off value ● switch-on value ● last value ● defined value	Uses this parameter to set the behaviors of the ECG when AC is repowered on. Actions are off, on, last value or set to a certain value. Note: If the "Standby switch off" function is enabled, it is recommended to set this parameter to "last value" to avoid the lamp turning on before performing other operations when AC is repowered on.
Value	● 100% ● 99% ... ● 0.8% ● 0.4% ● 0%(OFF)	Use this parameter to set a desired value
Note: The above parameters are only reset after downloading database, and will not be reset when KNX power is restored		
Switch-On value	● last on value ● defined value	Use this parameter to set the switch-on value. If you select "last on value", the value is set to the dim value prior to the lamp being switched off.

Value	<ul style="list-style-type: none"> ● 100% ● 99% ... ● 0.8% ● 0.4% 	Use this parameter to set a desired value
Switch-off value	<ul style="list-style-type: none"> ● 100% ● 99% ... ● 0.8% ● 0.4% ● 0%(OFF) 	Use this parameter to set the switch-off value
Switch-on fade time	<ul style="list-style-type: none"> ● Immediately ● 0.7s ● 1.0s ● 1.4s ... ● 90.5s [2s] 	Defines the time needed to achieve the required setting after switch-on. Note: Regardless of the brightness change, the time of the executed steps is determined by the fade time. Whenever the "switch on value" option value is called, the "switch on fade time" is used
Switch-off fade time	<ul style="list-style-type: none"> ● Immediately ● 0.7s ● 1.0s ● 1.4s ... ● 90.5s [2s] 	Defines the time needed to turn off or achieve the required setting after switch-off. Note: Regardless of the brightness change, the time of the executed steps is determined by the fade time. Whenever the "switch off value" option value is called, the "switch off fade time" is used.
Relative dimming fade time	<ul style="list-style-type: none"> ● Immediately ● 0.7s ● 1.0s ● 1.4s ... ● 90.5s [4s] 	Defines the time needed to achieve the required setting by relative dimming. Note: Regardless of the brightness change, the time of the executed steps is determined by the fade time.

Absolute dimming fade time	<ul style="list-style-type: none"> ● Immediately ● 0.7s ● 1.0s ● 1.4s ... ● 90.5s [4s] 	Defines the time needed to achieve the required setting by absolute dimming. Note: Regardless of the brightness change, the time of the executed steps is determined by the fade time. Whenever the 'defined value' option value is called, 'absolute dimming facade time' is used.
Enable switch OFF via relative dimming	<ul style="list-style-type: none"> ● no check ● check 	Allows switch off via relative dimming or not.
Minimum dimming value	<ul style="list-style-type: none"> ● 100% ● 99% ... ● 0.8% ● 0.4% ● 0%(OFF) 	Lowest, minimum allowed light value for relative and absolute dimming.
Maximum dimming value	<ul style="list-style-type: none"> ● 100% ● 99% ... ● 0.8% ● 0.4% ● 0%(OFF) 	Highest, maximum allowed light value for relative and absolute dimming.

The following chart shows the objects that belong to A:ECGs:

Num	Object name	Length	Description
53	[A:ECG 1] On/Off	1 bit	Use this object to switch the ECG on or off. The dimming value is set by the parameters "Switch-On value" and "Switch-off value"
	[A:ECG 1] Permanent ON	1 bit	When 'Staircase light' is selected as 'active', enable this object. Telegram value: 1= entering Permanent ON mode; 0=Exit Permanent ON mode

54	[A:ECG 1] Relative Dimming	4 bit	This object is used for the relative dimming of the ECG
55	[A:ECG 1] Permanent Dimming	1 byte	This object is used for the absolute dimming of the ECG

4.2.1.1.2 A:ECG-Status

DLC-02-KN can report on/off status and dimming value of the ECG. As shown in the figure below, in the ETS software, users can set whether to activate the report function and set the report period. The process of DLC-02-KN reporting lamp status is as follows: The internal program will send the "QUERYLAMP FAILURE" command every 3 seconds. Assuming that 100 ECGs are connected to the DALI A bus, ECG1 is accessed in the first 3 seconds, ECG2 is accessed in the 6th second, ECG100 is accessed in the 300th second, and a cycle is completed in 300 seconds, and then it will continue to cycle accordingly. If an ECGn is disconnected, short-circuited or opencircuited, the object "ECG failure (Status)" will report 1, otherwise it will report 0.

The screenshot shows the configuration interface for the A:ECG 1 Status object. The left sidebar is expanded to show 'A:ECG 1' and 'Status'. The main area displays four configuration items:

- Send On/Off status:** Set to 'at change' (dropdown menu).
- Send status cyclic(0=no active):** Set to '0' (input field) with 'Seconds' (unit).
- Send dimming value status:** Set to 'at change' (dropdown menu).
- Send status cyclic(0=no active):** Set to '0' (input field) with 'Seconds' (unit).

The chart shows the dynamic range for this parameter:

ETS-text	Dynamic range [default value]	Comment
Send On/Off status	<ul style="list-style-type: none"> ● no send, passive state object ● at change ● always at input of telegram 	Sends status signals from the object "On/Off (Status)" with the option you selected.
Send status cyclic (0=no active)	● 0~65535s [0s]	Sends status signals from the objects "On/Off (Status)" at intervals you desire.
Send dimming value status	<ul style="list-style-type: none"> ● no send, passive state object ● at change ● always at input of telegram 	Sends status signals from the object "Dimming Value (Status)" with the option you selected.
Send status cyclic (0=no active)	● 0~65535s [0s]	Sends status signals from the objects "Dimming Value (Status)" at intervals you desire.

The following chart shows the objects that belong to A:ECGs:

Num	Object name	Length	Description
56	[A:ECG 1] On/Off (Status)	1 bit	<p>Sends the on/off status of the ECG.</p> <ol style="list-style-type: none"> 1. The parameter "Send On/Off Status" chooses "no send, passive stage object". → update status but no send telegram. 2. The parameter "Send On/Off Status" chooses "at change" → send telegram in every on/off change. 3. The parameter "Send On/Off Status" chooses "always at input of telegram" → send telegram in every on/off command. 4. The parameter "Send Status cyclic" is at a certain time value → send telegram at regular intervals. <p>Note: When dimming value > 0, the current state is On, and when dimming value = 0, the current state is Off</p>

Num	Object name	Length	Description
57	[A:ECG 1] Dimming Value(Stat us)	1 byte	Sends the dimming value of the ECG. 1.The parameter "Send dimming value status" chooses "no send, passive stage object". → update value status but no send telegram. 2.The parameter "Send dimming value status" chooses "at change"→ send telegram in every dimming value change. 3.The parameter "Send dimming value status" chooses "always at input of telegram" → send telegram in every dimming command. 4.The parameter "Send Status cyclic" is at a certain time value→ send telegram at regular intervals.
63	[A:ECG 1] Failure (Status)	1 bit	Detects whether the ECG is disconnected, short circuit or open circuit. As long as one of these situations occurs, the object will report "1", otherwise it will report "0".

4.2.1.1.3 A:ECG – Functions

The "Functions" page includes the following functions: Panic mode, Lock, Auto off, Night mode, Operation hours calculation and Be in control of standby switch-off

Priority: Panic mode > Test mode (Central Battery Emergency System) > Lock > Normal operation

Panic mode

Behavior when enable Panic mode switch-on value

Behavior when disable Panic mode last value

Lock object polarity 0 = unlock;1 = lock 0 = lock;1 = unlock

Behavior at locking last value

Behavior at unlocking no action

Auto off

Auto-off threshold value 100%

Auto-off after 10 Seconds

Auto-off disable/enable object no object

Night mode

Delay time 10 Minutes

Behavior when enable Night mode switch-off value

Behavior when disable Night mode no action

Operation hours calculation

Select data type 4 Byte value in second(DTP 13,100) 2 Byte value in hour(DTP 7,007)

Operation hours limit 10000 Hours

Send status every(0=no active) 0 Hours

Be in control of standby switch-off

● Panic mode

When "Panic mode" is checked, the following parameters appear, which can be used to set the dimming value of the ECG in panic mode and when the panic mode is released.

Priority: Panic mode > Lock > Night mode.

Panic mode

Behavior when enable Panic mode switch-on value

Behavior when disable Panic mode last value

The chart shows the dynamic range for this parameter:

ETS-text	Dynamic range [default value]	Comment
Behavior when enable Panic mode	<ul style="list-style-type: none"> ● switch-off value ● switch-on value ● no action ● defined value 	Uses this parameter to set the behaviors of the ECG after the mode is triggered. Actions are off, on, no action or set to a certain value.
Value	<ul style="list-style-type: none"> ● 100% ● 99% ... ● 0.8% ● 0.4% ● 0%(OFF) [50%] 	Use this parameter to set a desired value.
Behavior when disable Panic mode	<ul style="list-style-type: none"> ● switch-off value ● switch-on value ● no action ● defined value ● last value 	Uses this parameter to set the behaviors of the ECG after the mode is released. Actions are off, on, no action or set to a certain value. If you choose "last value", the ECG back to the previous value before triggering the panic mode.
Value	<ul style="list-style-type: none"> ● 100% ● 99% ... ● 0.8% ● 0.4% ● 0%(OFF) 	Use this parameter to set a desired value

The following chart shows the objects that belong to A:ECG:

Num	Object name	Length	Description
6	[Dali A] Activate Panic Mode	1bit	DALI Bus A - Panic mode.Activates or deactivates the panic mode via the bus. This object is only valid when the parameter "Panic mode" of the ECGor Group is checked. Note:Priority:Panic mode>Lock>Night mode

● LOCK

Lock object polarity 0 = unlock;1 = lock 0 = lock;1 = unlock

Behavior at locking ▼

Behavior at unlocking ▼

The chart shows the dynamic range for this parameter:

ETS-text	Dynamic range [default value]	Comment
Lock object polarity	<ul style="list-style-type: none"> ● 0 = unlock; ● 1 = lock ● 0 = lock; ● 1 = unlock 	Sets which value will be interpreted as a lock order and which one as an unlock order. Note: Priority: Panic mode >Lock > Night Mode.
Behavior at locking	<ul style="list-style-type: none"> ● Switch-off value ● Switch-on value ● last value ● defined value 	Sets the action to be performed when a lock order is received. Note: Priority: Panic mode >Lock > Night Mode.
Value	<ul style="list-style-type: none"> ● 100% ● 99% ... ● 0.8% ● 0.4% ● 0%(OFF) 	Use this parameter to set a desired value.
Behavior at unlocking	<ul style="list-style-type: none"> ● Switch-off value ● Switch-on value ● no action ● defined value ● last value 	Sets the action to be performed when an unlock order is received. If you choose "last value", the ECG back to the previous value before the lock order
Value	<ul style="list-style-type: none"> ● 100% ● 99% ... ● 0.8% ● 0.4% ● 0%(OFF) 	Use this parameter to set a desired value.

The following chart shows the objects that belong to Lock:

Num	Object name	Length	Description
58	[A:ECG 1] Lock	1bit	This object is used to lock/unlock the ECG. Priority: Panic mode > Lock > Night mode
	[A:ECG 1] Lock	1bit	This object is used to lock/unlock the ECG. Priority: Panic mode > Lock > Night mode

● Auto off

The condition for triggering the "Auto off" function is: when it is detected that the current dimming value of the lamp is greater than or equal to the set auto-off threshold, the lamp will be set to 0% (off) after a delay time.

Auto off

Auto-off threshold value

Auto-off after Seconds

Auto-off disable/enable object

When "Auto off" is checked, the following parameters appear:

ETS-text	Dynamic range [default value]	Comment
Auto off	● Unchecked ● Checked	Use this parameter to activate the mode.
Auto-off threshold value	● 100% ● 99% ... ● 0.8% ● 0.4%	Set the threshold for auto off. Note: The auto off function can only be triggered when the current dimming value is greater than or equal to the auto off threshold.
Auto-off after	● 0-65535s [10s]	Time count before triggering the Auto Off mode.

ETS-text	Dynamic range [default value]	Comment
Auto-off disable/enable object	● no object ● 0=disable; 1 = enable ● 0=enable; 1 = disable	Whether to use the 'Auto off disable/enable' object.

The following chart shows the objects that belong to Auto off:

Num	Object name	Length	Description
59	[A:ECG 1] Auto Off	1 bit	This object is used to enable/disable the Auto Off function of the ECG

● Night mode

When "Night mode" is checked, the following parameters appear, which can be used to set the dimming value of the ECG in night mode and when the night mode is released.

ETS-text	Dynamic range [default value]	Comment
Night mode	● no check ● check	Use this parameter to activate the mode. Note: Priority: Panic mode > Lock > Night mode.
Delay time	● 0 – 65535mins [10]	Time count before setting to the dimming value after the mode is triggered.
Behavior when enable Night mode	● switch-off value ● switch-on value ● no action ● defined value	Uses this parameter to set the behaviors of the ECG after the mode is triggered. Actions are off, on, no action or set to a certain value.

ETS-text	Dynamic range [default value]	Comment
Value	<ul style="list-style-type: none"> ● 100% ● 99% ... ● 0.8% ● 0.4% ● 0%(OFF) 	Use this parameter to set a desired value.
Behavior when disable Night mode	<ul style="list-style-type: none"> ● switch-off value ● switch-on value ● no action ● defined value ● last value 	Uses this parameter to set the behaviors of the ECG after the mode is released. Actions are off, on, no action or set to a certain value. If you choose "last value", the ECG back to the previous value before triggering the night mode.
Value	<ul style="list-style-type: none"> ● 100% ● 99% ... ● 0.8% ● 0.4% ● 0%(OFF) 	Use this parameter to set a desired value.

The following chart shows the objects that belong to A:ECG:

Num	Object name	Length	Description
7	[Dali A] Activate Night Mode	1 bit	DALI Bus A - Night mode. Activates or deactivates the night mode via the bus. This object is only valid when the parameter "Night mode" of the ECG or Group is checked. Note: Priority: Panic mode>Lock>Night mode.

● Operation hours calculation & Be in control of standby switch-off
When "Operation hours calculation" is checked, the following parameters appear:

ETS-text	Dynamic range [default value]	Comment
Operation hours calculation	<ul style="list-style-type: none"> ● no check ● check 	Determines whether an individual operating hour calculation is required for the ECG.
Select data type	<ul style="list-style-type: none"> ● 4 Byte value in second ● 2 Byte value in hour 	Sends status signals from the object in seconds or in hours.
Operation hours limit	<ul style="list-style-type: none"> ● 1 – 65535h [10000] 	Sets the life span (operating hours limit) of the ECG. When the operation time is greater than the limit value, the object "Operation Hours Value" is cleared, and the object "Operation Hours Exceeded" will report an alarm.
Send status every (0=no active)	<ul style="list-style-type: none"> ● 0 – 255h [0] 	Sends status signals from the object "Operation Hours Value" at intervals you desire. Note: The set value of "Send status every" needs to be less than "Operation hours limit", otherwise the object "Operation Hours Value" cannot be reported.
Be in control of standby switch-off	<ul style="list-style-type: none"> ● no check ● checked 	Whether to activate 'Standby switch off'. Note: If "no check" is selected, the current ECG on or off will not be used as a condition for judging the standby switch off function, that is, the current ECG is independent of the standby switch off function.

The following chart shows the objects that belong to A:ECG:

Num	Object name	Length	Description
60	[A:ECG 1] Operation Hours Reset	1 bit	Resets the operating hours counter of the ECG.
61	[A:ECG 1] Operation Hours Value	4 bytes	The operating hours of the ECG in seconds are sent via this object. When the parameter "Select data type" is set to "4 Byte value in second(DTP 13.100)", the unit of operation time value is seconds.
	[A:ECG 1] Operation Hours Value	2 bytes	The operating hours of the ECG in hours are sent via this object. When the parameter "Select data type" is set to "2 Byte value in hour (DTP 7.007)", the unit of operation time value is hour.
62	[A:ECG 1] Operation Hours Exceeded	1 bit	When the operation hours ' counter exceeds the threshold set by the parameter "Operation hours limit"the object will send '1' and the operation hours' counter is reset to 0.

4.2.1.1.4 A:ECG – Staircase light

When the parameter "Staircase light" in the A: ECG page is selected as "active", a new Staircase light submenu will appear. Here, you can configure the lighting duration and warning mode of the staircase lights.

The chart shows the dynamic range for this parameter:

ETS-text	Dynamic range [default value]	Comment
Duration for staircase light	● 1-30000s [90s]	Used to set the lighting time for staircase lights. The brightness value of the staircase light is "Switch on value"
Prewarning	● not active ● active	Whether to activate the warning mode of the staircase lights before turning them off.

The following two parameters only appear when "Warning" is set to "active"		
Prewarning duration in	<ul style="list-style-type: none"> ● 1-30000s [10] 	The duration of the warning mode.
Value of dimming down	<ul style="list-style-type: none"> ● 100% ● 99% ... ● 0.8% ● 0.4% ● 0%(OFF) [20] 	The brightness value in warning mode.
Extension	<ul style="list-style-type: none"> ● not active ● active 	<ul style="list-style-type: none"> ● Active: During the lighting period of the staircase light, triggering the staircase light again will restart the timing process of the staircase light
Manual switching off	<ul style="list-style-type: none"> ● not active ● active 	Activate the function of manually turning off the staircase lights. If activated, the current staircase light can be turned off by sending object "staircase light"=0. If not activated, you can only wait for the entire process of staircase light to complete before turning off it.
Value of dimming down	<ul style="list-style-type: none"> ● 100% ● 99% ... ● 0.8% ● 0.4% ● 0%(OFF) [50%] 	Brightness in permanent ON mode. Object "permanent ON"=1 enters this mode; Object "permanent ON"=0 to exit this mode. Priority: Panic mode> permanent ON> staircase light.
when permanent OFF	<ul style="list-style-type: none"> ● Dimm down off ● start time of staircase light 	The action taken after the current ECG changes from the Permanent ON state to the Permanent OFF state.

The following chart shows the objects that belong to A:ECG:

Num	Object name	Length	Description
59	[A:ECG 1] Staircase light	1 bit	When "Staircase light" is selected as "active", the value of this object telegram is enabled: 1= Enable the Staircase light function; 0=If the parameter "Manual switching off" is selected as "active", the staircase light function can be turned off.

4.2.1.1.5 A:ECG-Colour control

Colour control type Colour Temperature ▾

The chart shows the dynamic range for this parameter:

ETS-text	Dynamic range [default value]	Comment
Colour control type	<ul style="list-style-type: none"> ● Colour Temperature ● RGB ● RGBW ● xy-coordinate 	Set the colour type of ECG. This parameter will be mapped to the "Scenes" page of the DCA APP. After selecting the colour control type, please click on the "Scenes" page in DCA to refresh.

The detailed introduction of each colour control type will be introduced in the following chapters:

※ Colour control type- Colour Temperature

Colour control type Colour Temperature

Colour value on DALI System Failure last colour value define colour value

Colour value 3000 K

Colour value on ECG Power On last colour value define colour value

Colour value 3000 K

Switch-on behavior Keep last object value Use defined value

Switch-on colour value 3000 K

Colour temperature object format 2-bytes Colour Temperature(DPT7.600) 1-byte Percentage(DPT5.001)

Sending colour value status at change

Colour changing fading time via dimming 4.0s

Colour temperature range setting by Scan or Reinstall function on DCA APP defined

Minimum colour temperature 2700 K

Maximum colour temperature 6500 K

The chart shows the dynamic range for this parameter:

ETS-text	Dynamic range [default value]	Comment
Colour value on DALI System Failure	<ul style="list-style-type: none"> ● last colour value ● define colour value 	Uses this parameter to set the colour temperature when DALI bus voltage falls down. <ul style="list-style-type: none"> ● last colour value: The colour temperature remains unchanged.
Colour Value	<ul style="list-style-type: none"> ● 1000 K..10000 K [3000K] 	Use this parameter to set a desired colour temperature. [This option only exists when "define colour value" in "Colour value on DALI System Failure" is chosen.]
Colour value on ECG Power On	<ul style="list-style-type: none"> ● last colour value ● define colour value 	Uses this parameter to set the colour temperature when AC power recovery of the ECG. <ul style="list-style-type: none"> ● last colour value: Use the colour temperature prior to the ECG being powered off.
Colour Value	<ul style="list-style-type: none"> ● 1000 K..10000 K [3000K] 	Use this parameter to set a desired colour temperature. [This option only exists when "define value" in "Colour value on ECG Power On" is chosen.]
Note: The above parameters are only reset after downloading database, and will not be reset when KNX power is restored.		
Switch-on behavior	<ul style="list-style-type: none"> ● Keep last object value ● Use defined value 	Use this parameter to set the switch-on colour temperature. If you select "Keep last object value", the value is set to the colour temperature prior to the lamp being switched off.
Switch-on colour value	<ul style="list-style-type: none"> ● 1000 K..10000 K [3000K] 	Use this parameter to set a desired colour temperature. [This option only exists when "Use defined value" in "Switch-On behavior" is chosen.]

ETS-text	Dynamic range [default value]	Comment
Colour temperature object format	<ul style="list-style-type: none"> ● 2-bytes Colour Temperature (DPT7.600) ● 1-byte Percentage (DPT5.001) 	Sets the format in which object "colour temperature" is transmitted.
Sending colour value status	<ul style="list-style-type: none"> ● no send, passive status object ● at change ● always at input of telegram 	Sends status signals from the object "Colour Temperature Value (Status)" with the option you selected.
Colour changing fading time via dimming	<ul style="list-style-type: none"> ● Immediately ● 0.7s ● 1.0s ● 1.4s ● 90.5s ● [4.0s] 	Defines the time needed to achieve the required colour temperature by dimming.
Colour temperature range setting by	<ul style="list-style-type: none"> ● Scan or Reinstall function on DCA APP ● defined 	Choose which method to use to set the colour temperature range.
Minimum colour temperature	<ul style="list-style-type: none"> ● 1000 K..10000 K ● [2000K] 	Use this parameter to set the minimum colour temperature of the lamp. [This option only exists when "defined" in "Colour temperature range setting by" is chosen.]
Maximum colour temperature	<ul style="list-style-type: none"> ● 1000 K..10000 K ● [6000K] 	Use this parameter to set the maximum colour temperature of the lamp. [This option only exists when "defined" in "Colour temperature range setting by" is chosen.]

The following chart shows the objects that belong to Colour Temperature:

Num	Object name	Length	Description
64	[A:ECG 1] Relative Colour Temperature	4bit	Relative colour temperature adjustment.
65	[A:ECG 1] Colour Temperature	2bytes	Absolute colour temperature adjustment.
66	[A:ECG 1] Colour Temperature Value(Status)	2bytes	Feedback the colour temperature value of the ECG.

※ Colour control type- RGB

Colour control type:

Colour value on DALI System Failure: last colour value define colour value

Colour value:

Colour value on ECG Power On: last colour value define colour value

Colour value:

Switch-on behavior: Keep last object value Use defined value

Switch-on colour value:

Sending colour value status:

Colour changing fading time via dimming:

The chart shows the dynamic range for this parameter:

ETS-text	Dynamic range [default value]	Comment
Colour value on DALI System Failure	<ul style="list-style-type: none"> ● last colour value ● define colour value 	<p>Uses this parameter to set the colour when DALI bus voltage falls down.</p> <ul style="list-style-type: none"> ● last colour value: The colour remains unchanged.
Colour Value	<ul style="list-style-type: none"> ● Colour selection [#FF0000] 	<p>Use this parameter to set a desired colour. [This option only exists when "define colour value" in "Colour value on DALI System Failure" is chosen.]</p>
Colour value on ECG Power On	<ul style="list-style-type: none"> ● last colour value ● define colour value 	<p>Uses this parameter to set the colour when AC power recovery of the ECG.</p> <ul style="list-style-type: none"> ● last colour value: Use the colour prior to the ECG being powered off.
Colour Value	<ul style="list-style-type: none"> ● Colour selection [#FF0000] 	<p>Use this parameter to set a desired colour. [This option only exists when "define colour value" in "Colour value on ECG Power On" is chosen.]</p>
<p>Note: The above parameters are only reset after downloading database, and will not be reset when KNX power is restored.</p>		
Switch-on behavior	<ul style="list-style-type: none"> ● Keep last object value ● Use defined value 	<p>Use this parameter to set the switch-on colour. If you select "Keep last object value", the value is set to the colour prior to the lamp being switched off.</p>
Switch-on colour value	<ul style="list-style-type: none"> ● Colour selection [#FF0000] 	<p>Use this parameter to set a desired colour. [This option only exists when "Use defined value" in "Switch-On behavior" is chosen.]</p>

ETS-text	Dynamic range [default value]	Comment
Sending colour value status	<ul style="list-style-type: none"> ● no send, passive status object ● at change ● always at input of telegram 	<p>Sends status signals from the object "Colour RGB Value (Status)" with the option you selected.</p>
Colour changing fading time via dimming	<ul style="list-style-type: none"> ● Immediately ● 0.7s ● 1.0s ● 1.4s ● 90.5s [4.0s] 	<p>Defines the time needed to achieve the required colour by dimming.</p>

The following chart shows the objects that belong to RGB:

Num	Object name	Length	Description
65	[A:ECG 1] Colour RGB	3bytes	Set the RGB value of the ECG.
66	[A:ECG 1] Colour RGB Value(Status)	3bytes	Feedback the RGB value of the ECG.

※ Colour control type- RGBW

Colour control type: RGBW

Colour value on DALI System Failure: last colour value define colour value

Colour value: #FF0000

Additional white value: 0

Colour value on ECG Power On: last colour value define colour value

Colour value: #FF0000

Additional white value: 255

Switch-on behavior: Keep last object value Use defined value

Switch-on colour value: #FF0000

Additional white value: 255

Sending colour value status: at change

Colour changing fading time via dimming: 4.0s

The chart shows the dynamic range for this parameter:

ETS-text	Dynamic range [default value]	Comment
Colour value on DALI System Failure	<ul style="list-style-type: none"> ● last colour value ● define colour value 	Uses this parameter to set the colour when DALI bus voltage falls down. ●last colour value: The colour remains unchanged.
Colour Value	<ul style="list-style-type: none"> ● Colour selection [#FF0000]	Use this parameter to set a desired colour. [This option only exists when "define colour value" in "Colour value on DALI System Failure" is chosen.]

ETS-text	Dynamic range [default value]	Comment
Additional white value	<ul style="list-style-type: none"> ● 0..255 (Slider) [0]	Use this parameter to set a desired white value. [This option only exists when "define colour value" in "Colour value on DALI System Failure" is chosen.]
Colour value on ECG Power On	<ul style="list-style-type: none"> ● last colour value ● define colour value 	Uses this parameter to set the colour when AC power recovery of the ECG. ●last colour value: Use the colour prior to the ECG being powered off.
Colour Value	<ul style="list-style-type: none"> ● Colour selection 	Use this parameter to set a desired colour. [This option only exists when "define colour value" in "Colour value on ECG Power On" is chosen.]
Additional white value	<ul style="list-style-type: none"> ● 0..255 (Slider) [255]	Use this parameter to set a desired white value. [This option only exists when "define colour value" in "Colour value on ECG Power On" is chosen.]
Note: The above parameters are only reset after downloading database, and will not be reset when KNX power is restored.		
Switch-on behavior	<ul style="list-style-type: none"> ● Keep last object value ● Use defined value 	Use this parameter to set the switch-on colour. If you select "Keep last object value", the value is set to the colour prior to the lamp being switched off.
Switch-on colour value	<ul style="list-style-type: none"> ● Colour selection [#FF0000]	Use this parameter to set a desired colour. [This option only exists when "Use defined value" in "Switch-On behavior" is chosen.]

ETS-text	Dynamic range [default value]	Comment
Additional white value	<ul style="list-style-type: none"> ● 0..255 (Slider) [255]	Use this parameter to set a desired white value. [This option only exists when "Use defined value" in "Switch-On behavior" is chosen.]
Sending colour value status	<ul style="list-style-type: none"> ● no send, passive status object ● at change ● always at input of telegram 	Sends status signals from the object "Colour RGBW Value (Status)" with the option you selected.
Colour changing fading time via dimming	<ul style="list-style-type: none"> ● Immediately ● 0.7s ● 1.0s ● 1.4s ● 90.5s [4.0s]	Defines the time needed to achieve the required colour by dimming.

The following chart shows the objects that belong to RGB:

Num	Object name	Length	Description
65	[A:ECG 1] Colour RGBW	6bytes	Set the RGBW value of the ECG.
66	[A:ECG 1] Colour RGBW Value (Status)	6bytes	Feedback the RGBW value of the ECG.

※ Colour control type- xy-coordinate

Colour control type:

Colour value on DALI System Failure: last colour value define colour value

Colour x-value:

Colour y-value:

Colour value on ECG Power On: last colour value define colour value

Colour x-value:

Colour y-value:

Switch-on behavior: Keep last object value Use defined value

Switch-on colour x-value(0..0.8):

Switch-on colour y-value(0..0.9):

Sending colour value status:

Colour changing fading time via dimming:

The chart shows the dynamic range for this parameter:

ETS-text	Dynamic range [default value]	Comment
Colour value on DALI System Failure	<ul style="list-style-type: none"> ● last colour value ● define colour value 	Uses this parameter to set the colour (xy-coordinate) when DALI bus voltage falls down. ● last colour value: The colour remains unchanged.
Colour x-value	<ul style="list-style-type: none"> ● 0,33 value between (0..1) 	Use this parameter to set a desired x-value. [This option only exists when "define colour value" in "Colour value on DALI System Failure" is chosen.]
Colour y-value	<ul style="list-style-type: none"> ● 0,33 value between (0..1) 	Use this parameter to set a desired y-value. [This option only exists when "define colour value" in "Colour value on DALI System Failure" is chosen.]

ETS-text	Dynamic range [default value]	Comment
Colour value on ECG Power On	<ul style="list-style-type: none"> ● last colour value ● define colour value 	<p>Uses this parameter to set the colour (xy-coordinate) when AC power recovery of the ECG.</p> <ul style="list-style-type: none"> ● last colour value: Use the colour prior to the ECG being powered off.
Colour x-value	<ul style="list-style-type: none"> ● 0,33 value between (0..1) 	<p>Use this parameter to set a desired x-value. [This option only exists when "define colour value" in "Colour value on ECG Power On" is chosen.]</p>
Colour y-value	<ul style="list-style-type: none"> ● 0,33 value between (0..1) 	<p>Use this parameter to set a desired y-value. [This option only exists when "define colour value" in "Colour value on ECG Power On" is chosen.]</p>
<p>Note: The above parameters are only reset after downloading database, and will not be reset when KNX power is restored.</p>		
Switch-on behavior	<ul style="list-style-type: none"> ● Keep last object value ● Use defined value 	<p>Use this parameter to set the switch-on colour (xy-coordinate). If you select "Keep last object value", the value is set to the colour prior to the lamp being switched off.</p>
Switch-on colour x-value (0..1)	<ul style="list-style-type: none"> ● 0,33 value between (0..1) 	<p>Use this parameter to set a desired x-value. [This option only exists when "Use defined value" in "Switch-On behavior" is chosen.]</p>
Switch-on colour y-value (0..1)	<ul style="list-style-type: none"> ● 0,33 value between (0..1) 	<p>Use this parameter to set a desired y-value. [This option only exists when "Use defined value" in "Switch-On behavior" is chosen.]</p>

ETS-text	Dynamic range [default value]	Comment
Sending colour value status	<ul style="list-style-type: none"> ● no send, passive status object ● at change ● always at input of telegram 	<p>Sends status signals from the object "Colour xy-coordinate Value (Status)" with the option you selected.</p>
Colour changing fading time via dimming	<ul style="list-style-type: none"> ● Immediately ● 0.7s ● 1.0s ● 1.4s ● 90.5s [4.0s] 	<p>Defines the time needed to achieve the required colour (xy-coordinate) by dimming.</p>

The following chart shows the objects that belong to RGB:

Num	Object name	Length	Description
65	[A:ECG 1] Colour xy-coordinate	6bytes	Set the xy-coordinate value of the ECG.
66	[A:ECG 1] Colour xy-coordinate Value(Status)	6bytes	Feedback the xy-coordinate value of the ECG.

4.2.2 A:Groups enable

<ul style="list-style-type: none"> - General <ul style="list-style-type: none"> General setting DALI setting Relays enable Sequences enable Timers enable - DALI A Configuration <ul style="list-style-type: none"> A:ECGs enable A:Groups enable A:Broadcast enable A:HCL/Dim2Warm functions A:DT1 Rest/Inhibit functions + DALI B Configuration - A:Groups <ul style="list-style-type: none"> + A:G1, + A:G2, 	<p>ENABLE A:GROUP</p> <ul style="list-style-type: none"> A:Group 1 <input checked="" type="checkbox"/> A:Group 2 <input checked="" type="checkbox"/> A:Group 3 <input type="checkbox"/> A:Group 4 <input type="checkbox"/> A:Group 5 <input type="checkbox"/> A:Group 6 <input type="checkbox"/> A:Group 7 <input type="checkbox"/> A:Group 8 <input type="checkbox"/> A:Group 9 <input type="checkbox"/> A:Group 10 <input type="checkbox"/> A:Group 11 <input type="checkbox"/> A:Group 12 <input type="checkbox"/> A:Group 13 <input type="checkbox"/> A:Group 14 <input type="checkbox"/> A:Group 15 <input type="checkbox"/> A:Group 16 <input type="checkbox"/>
---	---

The chart shows the dynamic range for this parameter:

ETS-text	Dynamic range [default value]	Comment
A:Group n n = [1, 16]	<ul style="list-style-type: none"> ● no check ● check 	Use this parameter to activate A: Group n.

The following chart shows the objects that belong to A:Groups:

Num	Object name	Length	Description
14	[Dali A] On/Off (Status Group1 Group16)	4 bytes	Sends the on/off status for groups 1- 16. Bit 0-15 refer to Group 1 to Group 16. For example: Grp.16 15 14 13... 3 2 1 Bit 15 14 13 12... 3 2 1 0 Group 3 on: 0 0 0 0 0 0 0 0 0 0 0 0 1 0 0

Once a group is activated, a new page of "A: Gn" will appear. At this subpage, the further parameterization can be done. Detailed information is described in the next sections

- A:Groups
+ A:G1,
+ A:G2,

4.2.2.1 A:Groups

The parameters of group can be set and modified through the left menu of A: Groups, which includes the following sections: Dimming setting, Status, Function, Staircase light and Colour control. Among them, the "Staircase light" submenu only appears when the parameter "Staircase light" is selected as "active"

Note: The difference between groups and ECG are that: ① groups do not have the function of polling brightness or color values; ② The color temperature of the group only supports manual setting and cannot be automatically obtained through DCA.

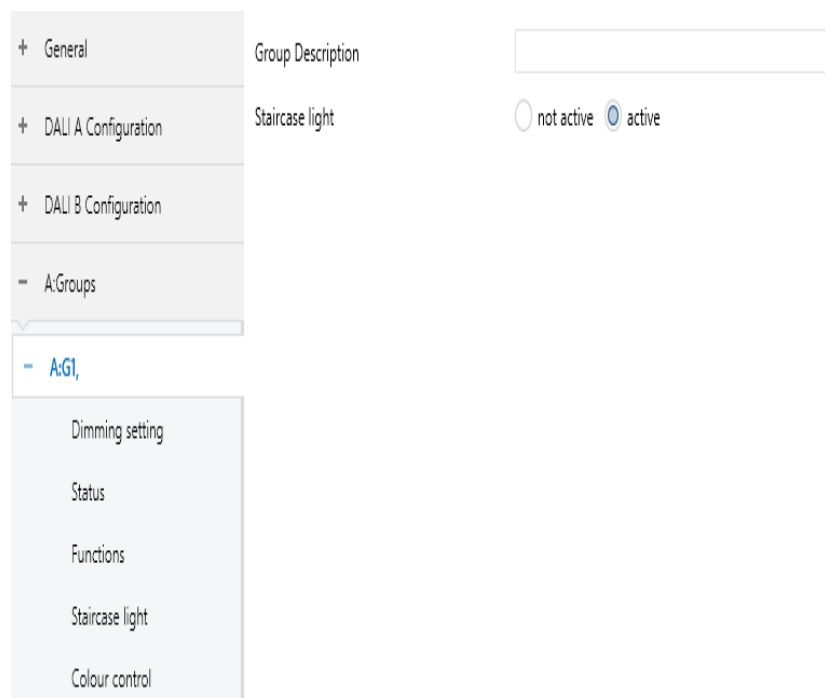

The chart shows the dynamic range for this parameter:

ETS-text	Dynamic range [default value]	Comment
Group Description	----	Custom description Group, with a maximum length of 30 bytes.
Staircase Light	<ul style="list-style-type: none"> ● not active ● active 	Use this parameter to activate the staircase light function. Note: After activating the staircase light function, the Lock, Auto off, and Night mode functions will be disabled.

The following chart shows the objects that belong to A:Groups:

Num	Object name	Length	Description
1019	[A:Group1] Staircase light	1 bit	When 'Staircase light' is selected as 'active', enable this object. Value of telegram: 1 =enable the staircase light function; 0 = If the parameter 'Manual switching off' is selected as 'active', the staircase light function can be turned off

4.2.2.1.1 A:G1 – Dimming setting

The chart shows the dynamic range for this parameter:

ETS文本	动态范围 [默认值]	说明
Value on DALI System Failure	<ul style="list-style-type: none"> ● switch-off value ● switch-on value ● last value ● defined value 	Uses this parameter to set the behaviors of the group when DALI bus voltage falls down. Actions are off, on, last value or set to a certain value.

Value	<ul style="list-style-type: none"> ● 100% ● 99% ... ● 0.8% ● 0.4% ● 0%(OFF) 	This option is only available when "Value on DALI System Failure" is selected as "defined value".
Value on ECG Power On	<ul style="list-style-type: none"> ● switch-off value ● switch-on value ● last value ● defined value 	Uses this parameter to set the behaviors of the group when AC is repowered on. Actions are off, on, last value or set to a certain value. Note: If the "Standby switch off" function is enabled, it is recommended to set this parameter to "last value" to avoid the lamp turning on before performing other operations when AC is repowered on.
Value	<ul style="list-style-type: none"> ● 100% ● 99% ... ● 0.8% ● 0.4% ● 0%(OFF) 	This option is only available when "Value on ECG Power On" is selected as "defined value".
Dimming curve	<ul style="list-style-type: none"> ● log ● linear 	Choose whether the dimming curve for the group is a logarithmic curve or a linear curve.
Note: The above parameters are only reset after downloading database, and will not be reset when KNX power is restored.		
Switch-On value	<ul style="list-style-type: none"> ● last on value ● defined on value 	Use this parameter to set the switch-on value. If you select "last on value", the value is set to the dim value prior to the lamp being switched off.

Value	<ul style="list-style-type: none"> ● 100% ● 99% ... ● 0.8% ● 0.4% 	Use this parameter to set a desired value.
Switch-Off value	<ul style="list-style-type: none"> ● 99% ... ● 0.8% ● 0.4% ● 0%(OFF) 	Use this parameter to set the switch-off value.
Switch-On fade time	<ul style="list-style-type: none"> ● Immediately ● 0.7s ● 1.0s ● 1.4s ... ● 90.5s [2s] 	Defines the time needed to achieve the required setting after switch-on. Note: Regardless of the brightness change, the time of the executed steps is determined by the fade time. Whenever the "switch on value" option value is called, the "switch on fade time" is used.
Switch-Off fade time	<ul style="list-style-type: none"> ● Immediately ● 0.7s ● 1.0s ● 1.4s ... ● 90.5s [2s] 	Defines the time needed to turn off or achieve the required setting after switch-off. Note: Regardless of the brightness change, the time of the executed steps is determined by the fade time. Whenever the "switch off value" option value is called, the "switch off fade time" is used.
Relative dimming fade time	<ul style="list-style-type: none"> ● Immediately ● 0.7s ● 1.0s ● 1.4s ... ● 90.5s [4s] 	Defines the time needed to achieve the required setting by relative dimming. Note: Regardless of the brightness change, the time of the executed steps is determined by the fade time.

Absolute dimming fade time	<ul style="list-style-type: none"> ● Immediately ● 0.7s ● 1.0s ● 1.4s ... ● 90.5s [4s] 	Defines the time needed to achieve the required setting by absolute dimming. Note: Regardless of the brightness change, the time of the executed steps is determined by the fade time. Whenever the 'defined value' option value is called, 'absolute dimming facade time' is used.
Enable switch OFF via relative dimming	<ul style="list-style-type: none"> ● no check ● check 	Allows switch off via relative dimming or not.
Minimum dimming value	<ul style="list-style-type: none"> ● 100% ● 99% ● 0.8% ● 0.4% ● 0%(OFF) 	Lowest, minimum allowed light value for relative and absolute dimming.
Maximum dimming value	<ul style="list-style-type: none"> ● 100% ● 99% ● 0.8% ● 0.4% ● 0%(OFF) 	Highest, maximum allowed light value for relative and absolute dimming.

The following chart shows the objects that belong to A:Groups:

Num	Object name	Length	Description
1013	[A:Group1] On/Off	1 bit	Use this object to switch the Group on or off. The dimming value is set by the parameters "Switch-On value" and "Switch-off value"
	[A:G1] Permanent ON	1 bit	When 'Staircase light' is selected as 'active', enable this object. Telegram value: 1=entering Permanent ON mode; 0=Exit Permanent ON mode
1014	[A:Group1] Relative Dimming	4 bit	This object is used for the relative dimming of the Group.
1015	[A:Group1] Absolute Dimming	1 byte	This object is used for the absolute dimming of the Group.

4.2.2.1.2 A:G1 – Status

DLC-02-KN can report on/off status and dimming value of the group. As shown in the figure below, in the ETS software, users can set whether to activate the report function and set the report period.

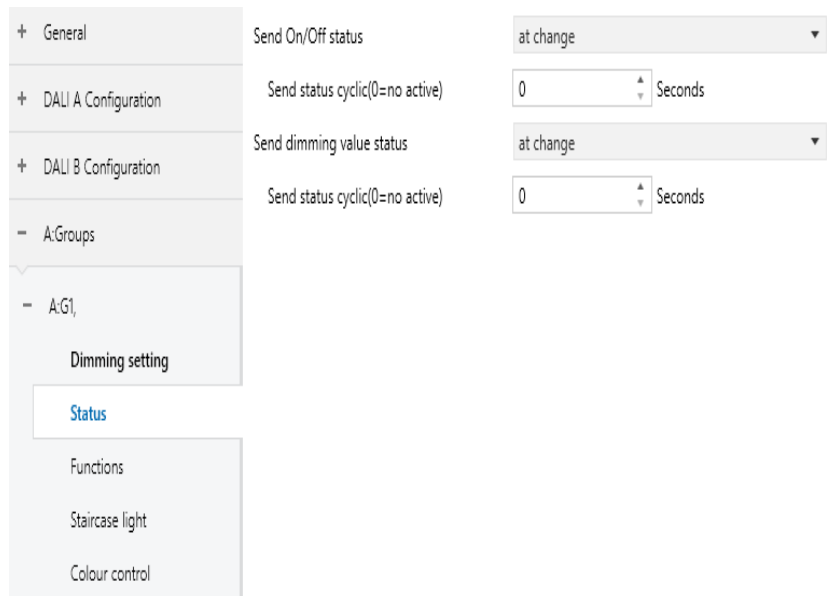

In addition, the DLC-02-KN also reports the lamp status via the object "failure (Status)". The group status includes whether the group is disconnected, short-circuited or open circuited. The process of DLC-02-KN reporting group status is as follows: The internal program will send the "QUERY LAMP FAILURE" command to access each ECG in the group every 3 seconds. Suppose there are 100 ECGs in group 1 on the DALI A bus, ECG1 is accessed in the first 3 seconds, ECG2 is accessed in the 6th second, ECG100 is accessed in the 300th second, and a cycle is completed in 300 seconds, and then it will continue to cycle accordingly. As long as one of the ECGs is disconnected, short-circuited or open-circuited, the object "Group Failure (Status)" will report 1, otherwise it will report 0.

The chart shows the dynamic range for this parameter:

ETS-text	Dynamic range [default value]	Comment
Send On/Off status	<ul style="list-style-type: none"> ● no send,passive state object ● at change ● always at input of telegram 	Sends status signals from the object "On/Off (Status)" with the option you selected.
Send status cyclic (0=no active)	● 0-65535s [0s]	Sends status signals from the objects "On/Off (Status)" at intervals you desire.
Send dimming value status	<ul style="list-style-type: none"> ● no send,passive state object ● at change ● always at input of telegram 	Sends status signals from the object "Dimming Value (Status)" with the option you selected.
Send status cyclic (0=no active)	● 0-65535s [0s]	Sends status signals from the objects "Dimming Value (Status)" at intervals you desire.

The following chart shows the objects that belong to A:ECGs:

Num	Object name	Length	Description
1016	[A:Group1] On/Off(Stat us)	1 bit	Sends the on/off status of the Group. 1.The parameter "SendOn/Off Status"chooses"no send, passive stage object" →update status but no send telegram 2.The parameter "SendOn/Off Status"chooses"at change"→send telegram in every on/off change. 3.The parameter "Send On/Off Status"chooses"always at input of telegram" →send telegram in every on/off command. 4.The parameter "Send Status cyclic" is at a certain time value→send telegram at regular intervals. Note: When dimming value >0, the current state is On, and when dimming value=0 the current state is Off.
1017	[A:Group1] Dimming Value (Status)	1 byte	Sends the dimming value of the Group. 1.The parameter "Send dimming value status" chooses "no send, passive stage object"→update value status but no send telegram. 2.The parameter "Send dimming value status "chooses"at change"→ send telegram in every dimming value change 3.The parameter "Send dimming value status "chooses"always at input of telegram" →send telegram in every dimming command. 4.The parameter "Send Status cyclic" is at a certain time value→send telegram at regular intervals.

Num	Object name	Length	Description
1023	[A:Group1] Failure (Status)	1 bit	Detect if there are any ECG drops, short circuits, or open circuits in the group. As long as one of the situations occurs in an ECG in the group, the object will report "1", otherwise it will report "0"

4.2.2.1.3 A:G1 – Functions

The "Functions" page includes the following functions: Panic mode, Lock, Auto off, Night mode and Operation hours calculation.

The screenshot displays the configuration interface for the 'Functions' section of A:G1. The settings are as follows:

- General:** Priority: Panic mode > Test mode (Central Battery Emergency System) > Lock > Normal operation
- Panic mode:** Enabled (checked).
- Behavior when enable Panic mode:** switch-on value
- Behavior when disable Panic mode:** last value
- A:Groups:** Lock object polarity: 0 = unlock; 1 = lock
- A:G1:**
 - Behavior at locking:** last value
 - Behavior at unlocking:** no action
- Auto off:** Enabled (checked).
- Auto-off threshold value:** 100%
- Auto-off after:** 10 Seconds
- Auto-off disable/enable object:** no object
- Night mode:** Enabled (checked).
- Delay time:** 10 Minutes
- Behavior when enable Night mode:** switch-off value
- Behavior when disable Night mode:** no action
- Operation hours calculation:** Enabled (checked).
- Select data type:** 4 Byte value in second(DTP 13.100)
- Operation hours limit:** 10000 Hours
- Send status every(0=no active):** 0 Hours

● Panic mode

When "Panic mode" is checked, the following parameters appear, which can be used to set the dimming value of the group in panic mode and when the panic mode is released.
Priority: Panic mode > Lock > Night mode.

Panic mode

Behavior when enable Panic mode

Behavior when disable Panic mode

The chart shows the dynamic range for this parameter:

ETS-text	Dynamic range [default value]	Comment
Behavior when enable Panic mode	<ul style="list-style-type: none"> ● switch-off value ● switch-on value ● no action ● defined value 	Uses this parameter to set the behaviors of the group after the mode is triggered. Actions are off, on, no action or set to a certain value.
Value	<ul style="list-style-type: none"> ● 100% ● 99% ... ● 0.8% ● 0.4% ● 0%(OFF) [50%] 	Use this parameter to set a desired value.

ETS-text	Dynamic range [default value]	Comment
Behavior when enable Panic mode	<ul style="list-style-type: none"> ● switch-off value ● switch-on value ● no action ● defined value ● last value 	Uses this parameter to set the behaviors of the group after the mode is released. Actions are off, on, no action or set to a certain value. If you choose "last value", the group back to the previous value before triggering the panic mode.
Value	<ul style="list-style-type: none"> ● 100% ● 99% ... ● 0.8% ● 0.4% ● 0%(OFF) 	Use this parameter to set a desired value

The following chart shows the objects that belong to A:G1:

Num	Object name	Length	Description
6	[Dali A] Activate Panic Mode	1bit	DALI Bus A - Panic mode. Activates or deactivates the panic mode via the bus. This object is only valid when the parameter "Panic mode" of the ECG or Group is checked. Note: Priority: Panic mode > Lock > Night mode.

● Lock

Lock object polarity 0 = unlock;1 = lock 0 = lock;1 = unlock

Behavior at locking

Behavior at unlocking

The chart shows the dynamic range for this parameter:

ETS-text	Dynamic range [default value]	Comment
Lock object polarity	<ul style="list-style-type: none"> ● 0=un lock ● 1=lock ● 0=lock ● 1=un lock 	Sets which value will be interpreted as a lock order and which one as an unlock order. Note: Priority: Panic mode > Lock > Night Mode.
Behavior at locking	<ul style="list-style-type: none"> ● switch-off value ● switch-on value ● last value ● defined value 	Sets the action to be performed when a lock order is received. Note: Priority: Panic mode > Lock > Night Mode.
Value	<ul style="list-style-type: none"> ● 100% ● 99% ... ● 0.8% ● 0.4% ● 0%(OFF) 	Use this parameter to set a desired value.
Behavior at unlocking	<ul style="list-style-type: none"> ● switch-off value ● switch-on value ● no action ● defined value ● last value 	Sets the action to be performed when an unlock order is received. If you choose "last value", the group back to the previous value before the lock order.

ETS-text	Dynamic range [default value]	Comment
Value	<ul style="list-style-type: none"> ● 100% ● 99% ... ● 0.8% ● 0.4% ● 0%(OFF) 	Use this parameter to set a desired value.

The following chart shows the objects that belong to Lock:

Num	Object name	Length	Description
1018	[A:Group1] Lock	1bit	This object is used to lock/unlock the Group Priority: Panic mode> Lock > Night mode.
	[A:Group1] Lock	1 bit	This object is used to lock/unlock the Group Priority: Panic mode> Lock > Night mode

● Auto off

The condition for triggering the "Auto off" function is: when it is detected that the current dimming value of the lamp is greater than or equal to the set auto-off threshold, the lamp will be set to 0% (off) after a delay time.

Auto off

Auto-off threshold value

Auto-off after Seconds

Auto-off disable/enable object

When "Auto off" is checked, the following parameters appear:

ETS-text	Dynamic range [default value]	Comment
Auto off	<ul style="list-style-type: none"> ● no check ● check 	Use this parameter to activate the mode.
Auto-off threshold value	<ul style="list-style-type: none"> ● 100% ● 99% ... ● 0.8% ● 0.4% 	Set the threshold for auto off. Note: The auto off function can only be triggered when the current dimming value is greater than or equal to the auto off threshold.
Auto-off after	<ul style="list-style-type: none"> ● 0-65535s [10s] 	Time count before triggering the Auto Off mode.
Auto-off disable/enable object	<ul style="list-style-type: none"> ● no object ● 0=disable 1=enable ● 0=enable 1=disable 	Whether to use the "Auto off disable/enable" object.

The following chart shows the objects that belong to Auto off:

Num	Object name	Length	Description
1019	[A:Group1] Auto Off	1bit	This object is used to enable/disable the Auto Off function of the Group
	[A:Group1] Staircase light	1 bit	When 'Staircase light' is selected as 'active', enable this object. Value of telegram: 1 = enable the staircase light function; 0 = If the parameter 'Manual switching off' is selected as 'active', the staircase light function can be turned off

● Night mode

When "Night mode" is checked, the following parameters appear, which can be used to set the dimming value of the group in night mode and when the night mode is released.

ETS-text	Dynamic range [default value]	Comment
Night mode	<ul style="list-style-type: none"> ● no check ● check 	Use this parameter to activate the mode. Note: Priority: Panic mode > Lock > Night mode.
Delay time	<ul style="list-style-type: none"> ● 0-65535min [10] 	Time count before setting to the dimming value after the mode is triggered.
Behavior when enable Night mode	<ul style="list-style-type: none"> ● switch-off mode ● switch-on value ● no action ● defined value 	Uses this parameter to set the behaviors of the group after the mode is triggered Actions are off, on, no action or set to a certain value.
Value	<ul style="list-style-type: none"> ● 100% ● 99% ... ● 0.8% ● 0.4% ● 0%(OFF) 	Use this parameter to set a desired value.

ETS-text	Dynamic range [default value]	Comment
Behavior when disable Night mode	<ul style="list-style-type: none"> ● switch-off mode ● switch-on value ● no action ● defined value ● last value 	<p>Uses this parameter to set the behaviors of the group after the mode is released. Actions are off, on, no action or set to a certain value. If you choose "last value" , the group back to the previous value before triggering the night mode.</p>
Value	<ul style="list-style-type: none"> ● 100% ● 99% ... ● 0.8% ● 0.4% ● 0%(OFF) 	Use this parameter to set a desired value

The following chart shows the objects that belong to A:G1:

Num	Object name	Length	Description
7	[Dali A] Activate Night Mode	1bit	DALI Bus A - Panic mode. Activates or deactivates the panic mode via the bus. This object is only valid when the parameter "Panic mode" of the ECG or Group is checked. Note: Priority: Panic mode > Lock > Night mode.

● Operation hours calculation

When "Operation hours calculation" is checked, the following parameters appear:

ETS-text	Dynamic range [default value]	Comment
Operation hours calculation	<ul style="list-style-type: none"> ● no check ● check 	Determines whether an individual operating hour calculation is required for the group.
Select data type	<ul style="list-style-type: none"> ● 4 Byte value in second ● 2 Byte value in hour 	Sends status signals from the object in seconds or in hours.
Operation hours limit	<ul style="list-style-type: none"> ● 1-65535h [10000] 	Sets the life span (operating hours limit) of the group. When the operation time is greater than the limit value, the object "Operation Hours Value" is cleared, and the object "Operation Hours Exceeded" will report an alarm.
Send status every (0=active)	<ul style="list-style-type: none"> ● 0-255h [0] 	Sends status signals from the object "Operation Hours Value" at intervals you desire. Note: The set value of "Send status every" needs to be less than "Operation hours limit", otherwise the object "Operation Hours Value" cannot be reported.

The following chart shows the objects that belong to A:G1:

Num	Object name	Length	Description
1020	[A:Group1] Operation Hours Reset	1bit	Resets the operating hours counter of the Group.
1021	[A:Group1] Operation Hours Value	4bytes	The operating hours of the Group in seconds are sent via this object. When the parameter "Select data type" is set to "4 Byte value in second(DTP 13.100)", the unit of operation time value is seconds.
	[A:Group1] Operation Hours Value	2 bytes	The operating hours of the Group in hours are sent via this object. When the parameter "Select data type" is set to "2 Byte value in hour (DTP 7.007)", the unit of operation time value is hour
1022	[A:Group1] Operation Hours Exeeded	1 bit	When the operation hours' counter exceeds the threshold set by the parameter "Operation hours limit"the object will send '1' and the operation hours' counter is reset to 0

4.2.2.1.4 A:G1 – Staircase light

When the parameter "Staircase light" in the A: G1 page is selected as "active", a new Staircase light submenu will appear. Here, you can configure the lighting duration and warning mode of the staircase lights.

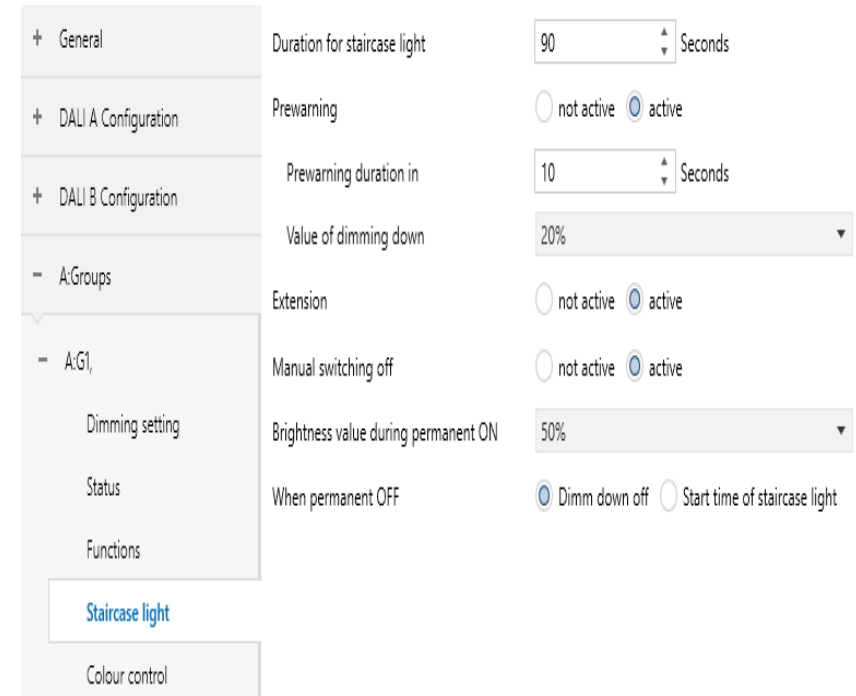

The chart shows the dynamic range for this parameter:

ETS-text	Dynamic range [default value]	Comment
Duration for staircase light	● 1-30000s [90s]	Used to set the lighting time for staircase lights. The brightness value of the staircase light is "Switch on value".

ETS-text	Dynamic range [default value]	Comment
Prewarning	<ul style="list-style-type: none"> ● not active ● active 	Whether to activate the warning mode of the staircase lights before turning them off.
The following two parameters only appear when "Warning" is set to "active"		
Prewarning duration in	<ul style="list-style-type: none"> ● 1-30000s [10]	The duration of the warning mode.
Value of dimming down	<ul style="list-style-type: none"> ● 100% ● 99% ... ● 0.8% ● 0.4% ● 0%(OFF) [20%]	The brightness value in warning mode.
Extension	<ul style="list-style-type: none"> ● not active ● active 	<ul style="list-style-type: none"> ● Active: During the lighting period of the staircase light, triggering the staircase light again will restart the timing process of the staircase light.
Manual switching off	<ul style="list-style-type: none"> ● not active ● active 	Activate the function of manually turning off the staircase lights. If activated, the current staircase light can be turned off by sending object "staircase light"=0. If not activated, you can only wait for the entire process of staircase light to complete before turning off it.

ETS-text	Dynamic range [default value]	Comment
Brightness value during permanent ON	<ul style="list-style-type: none"> ● 100% ● 99% ... ● 0.8% ● 0.4% ● 0%(OFF) [50%]	Brightness in permanent ON mode. Object "permanent ON"=1 enters this mode; Object "permanent ON"=0 to exit this mode. Priority: Panic mode > permanent ON > staircase light.
When permanent OFF	<ul style="list-style-type: none"> ● Dimm down off ● Start time of staircase light 	The action taken after the current group changes from the Permanent ON state to the Permanent OFF state.

The following chart shows the objects that belong to A:G1:

Num	Object name	Length	Description
1019	[A:Group1] Staircase light	1 bit	When 'Staircase light' is selected as 'active', enable this object. Value of telegram: 1 =enable the staircase light function; 0 = If the parameter 'Manual switching off' is selected as 'active', the staircase light function can be turned off

4.2.2.1.5 A:G-Colour control

Colour control type

none ▼

none ✓

Colour Temperature

RGB

RGBW

xy-coordinate

The chart shows the dynamic range for this parameter:

ETS-text	Dynamic range [default value]	Comment
Colour control type	<ul style="list-style-type: none"> <input checked="" type="radio"/> none <input type="radio"/> Colour Temperature <input type="radio"/> RGB <input type="radio"/> RGBW <input type="radio"/> xy-coordinate 	Set the colour type of the group, you can set the colour scene of the group through the DCA app.

The detailed introduction of each colour control type will be introduced in the following chapters:

※ Colour control type- Colour Temperature

Colour control type:

Colour value on DALI System Failure: last colour value define colour value

Colour value: K

Colour value on ECG Power On: last colour value define colour value

Colour value: K

Switch-on behavior: Keep last object value Use defined value

Switch-on colour value: K

Colour temperature object format: 2-bytes Colour Temperature(DPT7.600) 1-byte Percentage(DPT5.001)

Sending colour value status:

Colour changing fading time via dimming:

Minimum colour temperature: K

Maximum colour temperature: K

Use colour function:

State after KNX power recovery:

When colour function is active. Reaction on ...

object "Colour Temperature": Ignore Disable colour function

object "Relative Colour Temperature": Ignore Disable colour function

object "Scene": Ignore Disable colour function

Enable HCL object on page "DALI A Configuration / A:HCL/Dim2Warm functions"

The chart shows the dynamic range for this parameter:

ETS-text	Dynamic range [default value]	Comment
Colour value on DALI System Failure	<ul style="list-style-type: none"> <input checked="" type="radio"/> last colour value <input type="radio"/> define colour value 	Uses this parameter to set the colour temperature of the connected ECGs/lamps in the group when DALI bus voltage falls down. <ul style="list-style-type: none"> <input checked="" type="radio"/> last colour value: The colour temperature remains unchanged.
Colour Value	<input checked="" type="radio"/> 1000 K..10000 K [3000K]	Use this parameter to set a desired colour temperature
Colour value on ECG Power On	<ul style="list-style-type: none"> <input checked="" type="radio"/> last colour value <input type="radio"/> define colour value 	Uses this parameter to set the colour temperature of the connected ECGs/lamps in the group when AC power recovery. <ul style="list-style-type: none"> <input checked="" type="radio"/> last colour value: Use the colour temperature prior to the ECG being powered off.
Colour Value	<input checked="" type="radio"/> 1000 K..10000 K [3000K]	Use this parameter to set a desired colour temperature.
Note: The above parameters are only reset after downloading database, and will not be reset when KNX power is restored.		
Switch-on behavior	<ul style="list-style-type: none"> <input checked="" type="radio"/> Keep last object value <input type="radio"/> Use defined value 	Use this parameter to set the switch-on colour temperature of the connected ECGs/lamps in the group. If you select "Keep last object value", the value is set to the colour temperature prior to the lamp being switched off.

ETS-text	Dynamic range [default value]	Comment
Switch-on colour value	● 1000 K..10000 K [3000K]	Use this parameter to set a desired colour temperature.
Colour temperature object format	● 2-bytes Colour Temperature (DPT7.600) ● 1-byte Percentage (DPT5.001)	Sets the format in which object "colour temperature" of the group is transmitted.
Sending colour value status	● no send, passive status object ● at change ● always at input of telegram	Sends status signals from the object "Colour Temperature Value (Status)" of the group with the option you selected.
Colour changing fading time via dimming	● Immediately ● 0.7s ● 1.0s ● 1.4s ● 90.5s [4.0s]	Defines the time needed to achieve the required colour temperature by dimming.
Minimum colour temperature	● 1000 K..10000 K [2000K]	Use this parameter to set the minimum colour temperature of the group. Note: Manual setting is required here based on the actual minimum value of colour temperature read by DCA.

ETS-text	Dynamic range [default value]	Comment
Maximum colour temperature	● 1000 K..10000 K [6000K]	Use this parameter to set the maximum colour temperature of the group. Note: Manual setting is required here based on the actual maximum value of colour temperature read by DCA.
Use colour function	● not active ● Dim2Warm ● Central colour temperature(HCL)	This parameter is only valid when 'Colour control type' is selected as 'Colour Temperature'. Use this parameter to activate the colour function.
<p>The following parameters will only appear when the "Use color function" is set to "Dim2Warm" or "Central color temperature (HCL)".</p> <p>Note: When using this function, you need to select the parameter "Activate HCL object" in the "DALI A Configuration" section of the A: HCL/DIM2Warm functions.</p>		
State after KNX power recovery	● disable ● enable ● last value	This parameter defines the state of the colour function after the KNX bus voltage is restored. ● disable: After the KNX bus voltage is restored, the colour function is disabled. ● enable: After the KNX bus voltage is restored, the colour function is activated. ● last value: The colour function retains the operating state before the KNX bus voltage is restored (activated or disabled)

ETS-text	Dynamic range [default value]	Comment
Object "Colour Temperature"	<ul style="list-style-type: none"> ● Ignore ● Disable colour function 	<p>This parameter sets how the group/ECG responds when the colour function (Dim2 Warm or HCL) is activated and the colour temperature is set.</p> <ul style="list-style-type: none"> ● Ignore: Ignores the colour temperature setting and the colour function remains active. ● Disable colour function: Set the colour temperature and disable the colour function, using the set colour temperature.
Object "Relative Colour Temperature"	<ul style="list-style-type: none"> ● Ignore ● Disable colour function 	<p>This parameter sets how the group/ECG responds when the colour function (Dim2 Warm or HCL) is activated and the colour temperature is changed.</p> <ul style="list-style-type: none"> ● Ignore: Ignores the colour temperature changes and the colour function remains active. ● Disable colour function: Change the colour temperature and disable the colour function, using the changed colour temperature.

ETS-text	Dynamic range [default value]	Comment
Object "Scene"	<ul style="list-style-type: none"> ● Ignore ● Disable colour function 	<p>This parameter defines how the group/ECG responds when a colour function (Dim2Warm or HCL) is activated and the scene is called.</p> <ul style="list-style-type: none"> ● Ignore: The colour function remains active, ignoring scene changes. ● Disable function: The scene takes effect and the colour function is disabled Group response to scene changes.

The following chart shows the objects that belong to "Colour Temperature":

Num	Object name	Length	Description
1024	[A:Group1] Relative Colour Temperature	4bit	Relative colour temperature adjustment.
1025	[A:Group1] Colour Temperature	2bytes	Absolute colour temperature adjustment.
1026	[A:Group1] Colour Temperature Value(Status)	2bytes	Feedback the colour temperature value of the Group.

Num	Object name	Length	Description
1027	[A:G1] Activate HCL colour function/ Status	1 bit	When 'Use color function' is set to 'Central color temperature (HCL)' this object blocks or enables the HCL color function of the group. Telegram value: 1=activate the automatic HCL color function; 0=disable automatic HCL color function.

※ Colour control type- RGB

Colour control type:

Colour value on DALI System Failure: last colour value define colour value

Colour value:

Colour value on ECG Power On: last colour value define colour value

Colour value:

Switch-on behavior: Keep last object value Use defined value

Switch-on colour value:

Sending colour value status:

Colour changing fading time via dimming:

The chart shows the dynamic range for this parameter:

ETS-text	Dynamic range [default value]	Comment
Colour value on DALI System Failure	<ul style="list-style-type: none"> ● last colour value ● define colour value 	<p>Uses this parameter to set the colour of the connected ECGs/lamps in the group when DALI bus voltage falls down.</p> <ul style="list-style-type: none"> ● last colour value: The colour remains unchanged
Colour Value	<ul style="list-style-type: none"> ● Colour selection ● [#FF0000] 	Use this parameter to set a desired colour
Colour value on ECG Power On	<ul style="list-style-type: none"> ● last colour value ● define colour value 	<p>Uses this parameter to set the colour of the connected ECGs/lamps in the group when AC power recovery.</p> <ul style="list-style-type: none"> ● last colour value: Use the colour prior to the ECG being powered off.
Colour Value	<ul style="list-style-type: none"> ● Colour selection ● [#FF0000] 	Use this parameter to set a desired colour.
<p>Note: The above parameters are only reset after downloading database, and will not be reset when KNX power is restored.</p>		
Switch-on behavior	<ul style="list-style-type: none"> ● Keep last object value ● Use defined value 	Use this parameter to set the switch-on colour of the connected ECGs/lamps in the group. If you select "Keep last object value", the value is set to the colour prior to the lamp being switched off.
Switch-on colour value	<ul style="list-style-type: none"> ● [#FF0000] 	Use this parameter to set a desired colour.

ETS-text	Dynamic range [default value]	Comment
Sending colour value status	<ul style="list-style-type: none"> ● no send, passive status object ● at change ● always at input of telegram 	Sends status signals from the object "Colour RGB Value (Status)" of the group with the option you selected.
Colour changing fading time via dimming	<ul style="list-style-type: none"> ● Immediately ● 0.7s ● 1.0s ● 1.4s ● 90.5s [4.0s] 	Defines the time needed to achieve the required colour by dimming.

The following chart shows the objects that belong to "Colour RGB":

Num	Object name	Length	Description
1025	[A: Group1] Colour RGB	3bytes	Set the RGB value of the Group
1026	[A: Group1] Colour RGB Value(Status)	3bytes	Feedback the RGB value of the Group.

※ Colour control type- RGBW

Colour control type RGBW

Colour value on DALI System Failure last colour value define colour value

Colour value #FF0000

Additional white value

Colour value on ECG Power On last colour value define colour value

Colour value #FF0000

Additional white value

Switch-on behavior Keep last object value Use defined value

Switch-on colour value #FF0000

Additional white value

Sending colour value status at change

Colour changing fading time via dimming 4.0s

The chart shows the dynamic range for this parameter:

ETS-text	Dynamic range [default value]	Comment
Colour value on DALI System Failure	<ul style="list-style-type: none"> ● last colour value ● define colour value 	<p>Uses this parameter to set the colour of the connected ECGs/lamps in the group when DALI bus voltage falls down.</p> <ul style="list-style-type: none"> ●last colour value: The colour remains unchanged.
Colour Value	<ul style="list-style-type: none"> ● Colour selection [#FF0000] 	Use this parameter to set a desired colour.
Additional white value	<ul style="list-style-type: none"> ●0..255 (Slider) [0] 	Use this parameter to set a desired white value
Colour value on ECG Power On	<ul style="list-style-type: none"> ● last colour value ● define colour value 	<p>Uses this parameter to set the colour of the connected ECGs/lamps in the group when AC power recovery.</p> <ul style="list-style-type: none"> ●last colour value: Use the colour prior to the ECG being powered off.
Colour Value	<ul style="list-style-type: none"> ● Colour selection 	Use this parameter to set a desired colour.
Additional white value	<ul style="list-style-type: none"> ●0..255 (Slider) [255] 	Use this parameter to set a desired white value.
Note: The above parameters are only reset after downloading database, and will not be reset when KNX power is restored.		

ETS-text	Dynamic range [default value]	Comment
Switch-on behavior	<ul style="list-style-type: none"> ● Keep last object value ● Use defined value 	Use this parameter to set the switch-on colour of the connected ECGs/lamps in the group. If you select "Keep last object value" , the value is set to the colour prior to the lamp being switched off.
Switch-on colour value	<ul style="list-style-type: none"> ● Colour selection [#FF0000] 	Use this parameter to set a desired colour.
Additional white value	<ul style="list-style-type: none"> ●0..255 (Slider) [255] 	Use this parameter to set a desired white value.
Sending colour value status	<ul style="list-style-type: none"> ● no send, passive status object ● at change ● always at input of telegram 	Sends status signals from the object "Colour RGBW Value (Status)" of the group with the option you selected
Colour changing fading time via dimming	<ul style="list-style-type: none"> ● Immediately ● 0.7s ● 1.0s ● 1.4s ● 90.5s [4.0s] 	Defines the time needed to achieve the required colour by dimming.

The following chart shows the objects that belong to "Colour RGBW":

Num	Object name	Length	Description
1025	[A: Group1] Colour RGBW	6bytes	Set the RGBW value of the Group
1026	[A:Group1] Colour RGBW Value(Status)	6bytes	Feedback the RGBW value of the Group

※ Colour control type- xy-coordinate

Colour control type: xy-coordinate

Colour value on DALI System Failure: last colour value define colour value

Colour x-value: 0.33

Colour y-value: 0.33

Colour value on ECG Power On: last colour value define colour value

Colour x-value: 0.33

Colour y-value: 0.33

Switch-on behavior: Keep last object value Use defined value

Switch-on colour x-value(0..0.8): 0.33

Switch-on colour y-value(0..0.9): 0.33

Sending colour value status: at change

Colour changing fading time via dimming: 4.0s

The chart shows the dynamic range for this parameter:

ETS-text	Dynamic range [default value]	Comment
Colour value on DALI System Failure	<ul style="list-style-type: none"> ● last colour value ● define colour value 	Use this parameter to set the colour of the connected ECGs/lamps in the group when DALI bus voltage falls down <ul style="list-style-type: none"> ● last colour value: The colour remains unchanged
Colour x-value	● 0,33 value between (0..1)	Use this parameter to set a desired x-value
Colour y-value	● 0,33 value between (0..1)	Use this parameter to set a desired y-value.

ETS-text	Dynamic range [default value]	Comment
Colour value on ECG Power On	<ul style="list-style-type: none"> ● last colour value ● define colour value 	Uses this parameter to set the colour (xy coordinate) of the connected ECGs/lamps in the group when AC power recovery. <ul style="list-style-type: none"> ● last colour value: Use the colour prior to the ECG being powered off.
Colour x-value	● 0,33 value between (0..1)	Use this parameter to set a desired x-value
Colour y-value	● 0,33 value between (0..1)	Use this parameter to set a desired y-value
Note: The above parameters are only reset after downloading database, and will not be reset when KNX power is restored.		
Switch-on behavior	<ul style="list-style-type: none"> ● Keep last object value ● Use defined value 	Use this parameter to set the switch-on colour (xycoordinate) of the connected ECGs/lamps in the groups. Use this parameter to set a desired colour.
Switch-on colour x-value (0..1)	● 0,33 value between (0..1)	Use this parameter to set a desired x-value.
Switch-on colour y-value (0..1)	● 0,33 value between (0..1)	Use this parameter to set a desired y-value.
Sending colour value status	<ul style="list-style-type: none"> ● no send, passive status object ● at change ● always at input of telegram 	Sends status signals from the object "Colour xy-coordinate Value (Status)" of the group with the option you selected.
Colour changing fading time via dimming	<ul style="list-style-type: none"> ● Immediately ● 0.7s ● 1.0s ● 1.4s ● 90.5s [4.0s] 	Defines the time needed to achieve the required colour(xy-coordinate) by dimming.

The following chart shows the objects that belong to "xy-coordinate"

Num	Object name	Length	Description
1025	[A:Group 1] Colour xy-coordinate	6bytes	Set the xy-coordinate value of the Group.
1026	[A:Group 1] Colour xy-coordinate Value(Status)	6bytes	Feedback the xy-coordinate value of the Group.

4.2.3 A:Broadcast enable

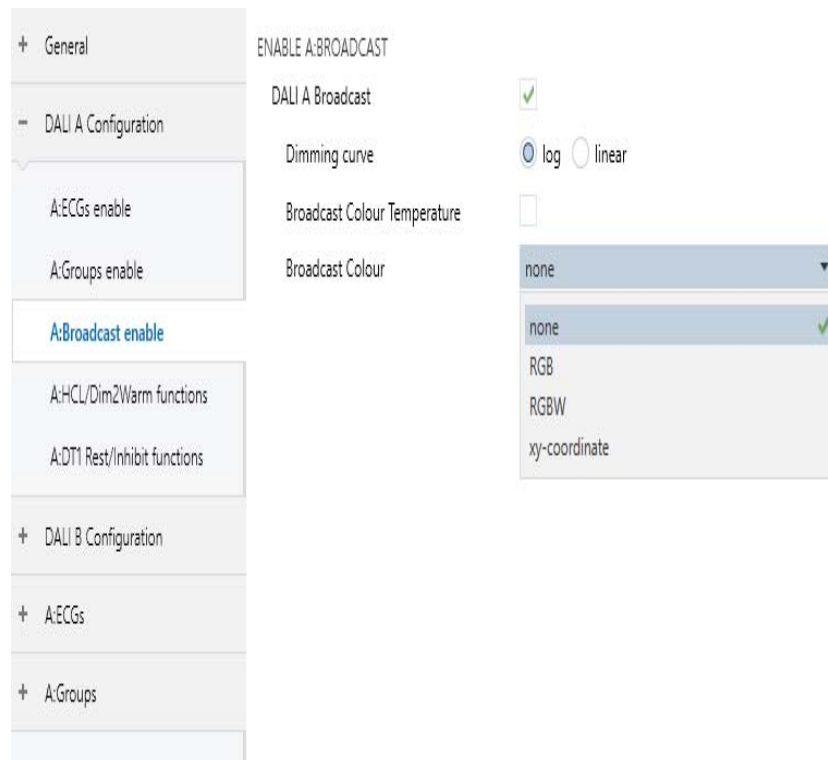

The chart shows the dynamic range for this parameter:

ETS-text	Dynamic range [default value]	Comment
DALI A Broadcast	<ul style="list-style-type: none"> ● no check ● check 	Use this parameter to enable the broadcast function
Dimming curve	<ul style="list-style-type: none"> ● log ● linear 	Sets the dimming curve for broadcast dimming. NOTE: This parameter only sends diming telegrams according to your setting and will not transfer the values to match the dimming curve of the ECGs /lamps. Please select the same curve as the ECGs/ lamps to get the best dimming performance.
Broadcast Colour Temperature	<ul style="list-style-type: none"> ● no check ● check 	Activate or deactivate the broadcast colour temperature control object.
Broadcast Colour	<ul style="list-style-type: none"> ● none ● RGB ● RGBW ● xy-coordinate 	Select the broadcast colour control type.

The following chart shows the objects that belong to DALI A.

Num	Object name	Length	Description
1	[Dali A] Broadcast Switch	1 bit	DALI Bus A - Broadcast Switch. This object is used to switch all connected lamps simultaneously on or off
2	[Dali A] Broadcast Absolute Dimming	1 byte	DALI Bus A - Broadcast Absolute Dimming. This object is used to simultaneously set all connected lamps to a certain brightness.
3	[Dali A] Broadcast Colour Temperature	2 bytes	DALI Bus A -Broadcast Colour Temperature. This object is used to simultaneously set all connected colour temperature lamps to a certain colour temperature.This operation will disable all 'Activate HCL color functions' and 'Activate Dim2Warm color functions'
4	[Dali A] Broadcast Colour RGB	3 bytes	DALI Bus A -Broadcast Colour RGB. This object is used to simultaneously set all connected RGB lamps to a certain colour
	[Dali A] Broadcast Colour RGBW	6 bytes	DALI Bus A -Broadcast Colour RGBW. This object is used to simultaneously set all connected RGBW lamps to a certain colour.
	[Dali A] Broadcast Colour xy-coordinate	6 bytes	DALI Bus A -Broadcast Colour xy-coordinate. This object is used to simultaneously set all connected xy-coordinate lamps to a certain colour.

4.2.4 A:HCL/Dim2Warm functions

- General
- General setting
- DALI setting
- Relays enable
- Sequences enable
- Timers enable
- DALI A Configuration
- A:ECGs enable
- A:Groups enable
- A:Broadcast enable
- A:HCL/Dim2Warm functions
- A:DT1 Rest/Inhibit functions
- + DALI B Configuration

HCL SETTING

HCL colour temperature source HCL colour temperature (2-bytes object) ▼

Initial colour temperature 3000 ▲▼ K

Transition time 32 ▲▼ Seconds

Activate HCL object

DIM2WARM SETTING

Limit proportional range

Lower brightness limit 20% ▼

Upper brightness limit 80% ▼

Limit colour temperature range

Minimum colour temperature 2700 ▲▼ K

Maximum colour temperature 4500 ▲▼ K

Activate Dim2Warm object

4.2.4.1 HCL SETTING

HCL SETTING

HCL colour temperature source Ramp curve (1-bit object) ▼

Rising ramp

Initial colour temperature 2700 ▲▼ K

Final colour temperature 6500 ▲▼ K

Transition time 7200 ▲▼ Seconds

Falling ramp

Initial colour temperature 6500 ▲▼ K

Final colour temperature 2700 ▲▼ K

Transition time 7200 ▲▼ Seconds

Activate HCL object

The chart shows the dynamic range for this parameter:

ETS-text	Dynamic range [default value]	Comment
HCL colour temperature source	<ul style="list-style-type: none"> ● HCL colour temperature (2-bytes object) ● Ramp curve (1-bit object) ● HCL 24h Curve (1-bit object) 	This parameter specifies the HCL color temperature source. Each source option produces different HCL characteristics

4.2.4.1.1 HCL colour temperature source - HCL colour temperature (2-bytes onbject)

HCL colour temperature(2-bytes object) :

Two byte colour temperature group objects. It is the source of HCL features. The HCL function follows the values sent by this group of objects. The DALI gateway adjusts all contained ECGS or groups to the colour temperature value sent by the object. The higher the frequency at which the group object sends colour temperature values, the more accurately the light can simulate the changing effect of the day.

HCL colour temperature source

Initial colour temperature K

Transition time Seconds

Activate HCL object

The chart shows the dynamic range for this parameter:

ETS-text	Dynamic range [default value]	Comment
Initial colour temperature	● 1000-10000K [3000K]	This parameter defines the initial colour temperature value of the HCL curve when the KNX power supply is powered on.
Transition time	● 0-65535s [32s]	This parameter defines the time required for the HCL curve to gradually transition from the current colour temperature to the new colour temperature.
Activate HCL object	<ul style="list-style-type: none"> ● no check ● check 	Use this parameter to activate the 'Activate automatic HCL colour function' object. This object automatically activates or disables the HCL function of the entire output. <ul style="list-style-type: none"> ● no check: Do not activate the "Activate automatic HCL colour function" group object. ● check: Activate the "Activate automatic HCL colour function" group object. This group object controls all groups.

The following chart shows the objects that belong to DALI A.

Num	Object name	Length	Description
21	[Dali A] HCL Colour Temperature	2 bytes	Enable this object when 'HCL colour temperature source' is set to 'HCL colour temperature (2-bytes object)'. This object is used to control the colour temperature value of HCL
22	[Dali A] Activate automatic HCL colour function	1 bit	If 'Enable activate HCL object' is set to 'check', then the object is enabled. This object activates or disables the automatic HCL colour function. The value of the telegram: 1=Activate the automatic HCL colour function; 0=Disable the automatic HCL colour function

4.2.4.1.1 HCL colour temperature source - Ramp curve(1-bit object)

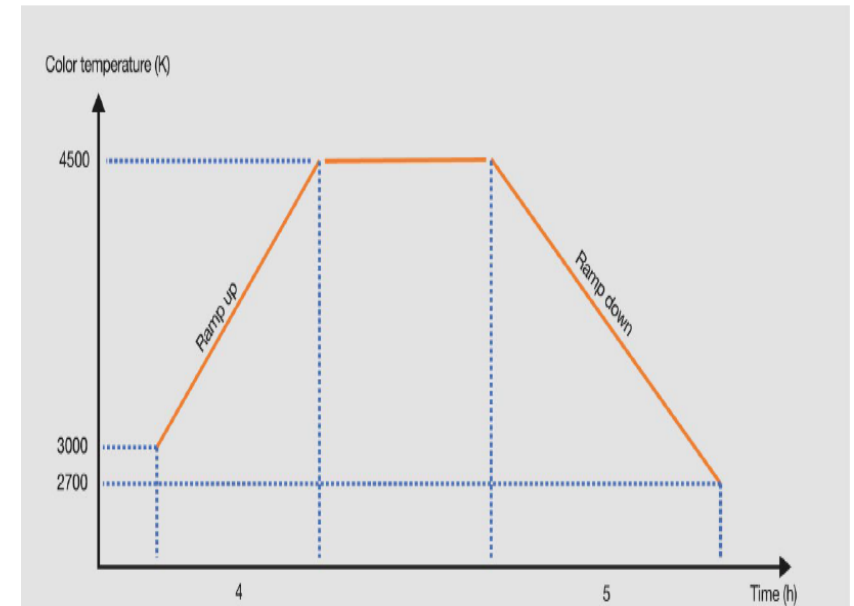

Ramp curve(1-bit object):

1-bit slope curve group object. It can parameterize the colour temperature slope curve. For example, Object "HCL ramp up/down" (value 0) triggers an ascending gradient, starting at a colour temperature of 3000K, and after 4 hours, reaching the set value of 4500K (final colour temperature). Then, the colour temperature value remains at the set value until the "HCL ramp up/down" group object triggers a descent slope (value 1), starting at 4500K and changing to 2700K after 5 hours.

Note: When the "HCL ramp up/down" group object triggers an upward slope, if the current colour temperature of the group/ECG is not the initial colour temperature of the ramp curve, it takes a fixed time of 4 seconds to gradually change to the initial colour temperature of the ramp curve before making changes based on the upward slope curve.

HCL colour temperature source Ramp curve (1-bit object) ▾

Rising ramp

Initial colour temperature 2700 K

Final colour temperature 6500 K

Transition time 7200 Seconds

Falling ramp

Initial colour temperature 6500 K

Final colour temperature 2700 K

Transition time 7200 Seconds

Activate HCL object

The chart shows the dynamic range for this parameter:

ETS-text	Dynamic range [default value]	Comment
Rising ramp		
Initial colour temperature	● 1000-10000K [2700K]	This parameter defines the colour temperature at the beginning of the upward slope.
Final colour temperature	● 1000-10000K [6500K]	This parameter defines the colour temperature at the end of the rising slope.
Transition time	● 0-65535s [3600s]	This parameter defines the ramp up time, which is the time required for the ramp from start to end.

ETS-text	Dynamic range [default value]	Comment
Falling ramp		
Initial colour temperature	● 1000-10000K [6500K]	This parameter defines the colour temperature at the beginning of the descent slope.
Final colour temperature	● 1000-10000K [2700K]	This parameter defines the colour temperature at the end of the descent slope.
Transition time	● 0-65535s [3600s]	This parameter defines the descent ramp time, which is the time required for the ramp from start to end.
Activate HCL object	● no check ● check	Use this parameter to activate the 'Activate automatic HCL colour function' object. This object automatically activates or disables the HCL function of the entire output. ● no check: Do not activate the "Activate automatic HCL colour function" group object. ● check: Activate the "Activate automatic HCL colour function" group object. This group object controls all groups.

The following chart shows the objects that belong to DALI A.

Num	Object name	Length	Description
21	[Dali A] HCL ramp up/down	1 bit	When the "HCL color temperature source" is set to "Ramp curve (1-bit object)," this object is enabled. This object triggers the HCL slope curve. The telegram values are: 0=start rising slope; 1=start descending slope
22	[Dali A] Activate automatic HCL colour function	1 bit	If 'Enable activate HCL object' is set to 'check', then the object is enabled. This object activates or disables the automatic HCL colour function. The value of the telegram: 1=Activate the automatic HCL colour function; 0=Disable the automatic HCL colour function

4.2.4.1.3 HCL colour temperature source - HCL 24h Curve (1-bit object)

HCL colour temperature source HCL 24h Curve (1-bit object) ▾

When "HCL 24h Curve (1-bit object)" is selected, a new sub page "A: HCL 24h Curve" will appear. Here, you can customize the 1-24 hour colour temperature change curve, triggered by the Object "HCL 24-hour Curve" (value 1).

- General

General setting

DALI setting

Relays enable

Sequences enable

Timers enable

01h	02h	03h	04h	05h	06h
3000 <small>↕ K</small>	3000 <small>↕ K</small>	3000 <small>↕ K</small>	3000 <small>↕ K</small>	3000 <small>↕ K</small>	3000 <small>↕ K</small>
07h	08h	09h	10h	11h	12h
4500 <small>↕ K</small>	4900 <small>↕ K</small>	5300 <small>↕ K</small>	5800 <small>↕ K</small>	6000 <small>↕ K</small>	6000 <small>↕ K</small>
13h	14h	15h	16h	17h	18h
6000 <small>↕ K</small>	6000 <small>↕ K</small>	5900 <small>↕ K</small>	5700 <small>↕ K</small>	5300 <small>↕ K</small>	4800 <small>↕ K</small>
19h	20h	21h	22h	23h	24h
4300 <small>↕ K</small>	3600 <small>↕ K</small>	3000 <small>↕ K</small>	3000 <small>↕ K</small>	3000 <small>↕ K</small>	3000 <small>↕ K</small>

- DALI A Configuration

A:ECGs enable

A:Groups enable

A:Broadcast enable

- A:HCL/Dim2/Warm functions

A:HCL 24h Curve

A:DT1 Rest/Inhibit functions

+ DALI B Configuration

The chart shows the dynamic range for this parameter:

ETS-text	Dynamic range [default value]	Comment
01h-24h	● 1000-10000K [3000K]	Customize the 1-24 hour colour temperature change curve.

The following chart shows the objects that belong to DALI A:

Num	Object name	Length	Description
21	[Dali A] HCL 24h Curve	1 bit	When the "HCL colour temperature source" is set to "HCL 24-hour Curve (1-bit object)", enable this object to trigger the HCL 24-hour Curve function
22	[Dali A] Activate automatic HCL colour function	1 bit	If 'Enable activate HCL object' is set to 'check', then the object is enabled. This object activates or disables the automatic HCL colour function. The value of the telegram: 1=Activate the automatic HCL colour function; 0=Disable the automatic HCL colour function

4.2.4.2 "HCL 24h curve" example

Taking office lighting as an example, assume that there are a total of 12 colour temperature lamps in the first floor interior. They are connected to the DALI-A bus and assigned to the same group "A: Group 1". We will use the HCL function to dynamically adjust the colour temperature of the light, achieving the effect shown in the following figure.



Operating Steps (Step 1~5 can be set offline; Step 6~10 needs to be set online.):

Step 1: Activate A: Group 1 on the "A: Groups enable" page.

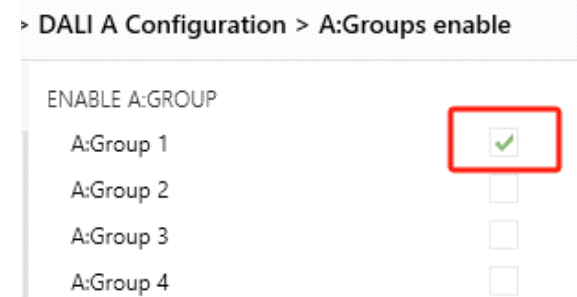

Step 2: On the "A: HCL/Dim2Warn functions" page, the parameter "HCL colour temperature source" is selected as "HCL 24h Curve (1-bit object)". The parameter "Activate HCL object" is unchecked.

Note: When the parameter "Activate HCL object" is checked, the object "[DALI A] Activate automatic HCL colour function" is available. This object is used as a block function to prevent all groups from entering HCL mode. If you do not need this object, please leave the parameter "Activate HCL object" unchecked.

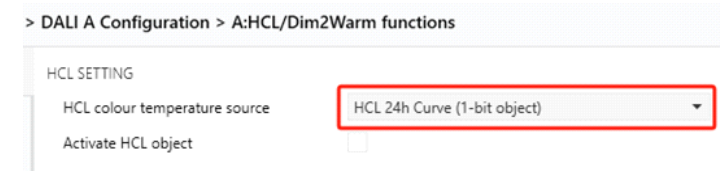

Step 3: On the "A: HCL 24-hour Curve" page, set the 24-hour colour temperature curve as shown in the following figure.

> DALI A Configuration > A:HCL/Dim2Warn functions > A:HCL 24h Curve

01h	02h	03h	04h	05h	06h
3500 ↕ K	3500 ↕ K	3500 ↕ K	3500 ↕ K	3500 ↕ K	3500 ↕ K
07h	08h	09h	10h	11h	12h
3500 ↕ K	3500 ↕ K	4000 ↕ K	4500 ↕ K	5000 ↕ K	5300 ↕ K
13h	14h	15h	16h	17h	18h
5600 ↕ K	6000 ↕ K	5600 ↕ K	5000 ↕ K	4500 ↕ K	4000 ↕ K
19h	20h	21h	22h	23h	24h
3500 ↕ K	3200 ↕ K	3200 ↕ K	3200 ↕ K	3200 ↕ K	3200 ↕ K

Step 4: On the "Colour control" page of "A: G1", the parameter "Colour control type" is selected as "Colour Temperature" and the parameter "Use colour function" is selected as "Central colour temperature (HCL)". In this example, the parameter "Disable colour function" is unchecked.

Note: If the parameter "Disable colour function" is checked, manually sending the "colour temperature" command during the execution of the HCL function will disable the HCL function. If you want to enable the HCL function again, you need to have Object "[A: G1] Activate HCL colour function/Status" send the "Enable" command first, and then have Object "[DALI A] HCL 24-hour Curve" send the "On" command.

A:Groups > A:G1, > Colour control

The parameter "Color control type" will be mapped to the "Scene" page of the DCA APP. After selecting the color control type, please click on the "Scene" page to refresh.

Colour control type: **Colour Temperature**

Colour value on DALI System Failure: last colour value define colour value

Colour value on ECG Power On: last colour value define colour value

Switch-on behavior: Keep last object value Use defined value

Colour temperature object format: 2-bytes Colour Temperature(DPT7.600) 1-byte Percentage(DPT5.001)

Sending colour value status: at change

Colour changing fading time via dimming: 4.0s

Minimum colour temperature: 2700 K

Maximum colour temperature: 6500 K

Use colour function: **Central colour temperature(HCL)**

State after KNX power recovery: disable

When colour function is active. Reaction on ...

object "Colour Temperature": Ignore Disable colour function

object "Relative Colour Temperature": Ignore Disable colour function

object "Scene": Ignore Disable colour function

Enable HCL object on page "DALI A Configuration / A:HCL/Dim2Warm functions"

Step 5: On the "DCA - DALI A – Groups" page, assign ECG 1 to ECG 12 in the same group "A: Group 1".

DALI A		A Group 1(plan) Description:	
Installation	Groups	ECG NO.	ECG Description
		ECG 1	
		ECG 2	
		ECG 3	
		ECG 4	
		ECG 5	
		ECG 6	
		ECG 7	
		ECG 8	
		ECG 9	
		ECG 10	
		ECG 11	
		ECG 12	

Step 6: Use the ETS "Download ALL" to load the individual address and application into the gateway and devices.

Download Highlight

Download All

Download Partial

Download Individual Address

Overwrite Individual Address

Download Application

Step 7: On the DCA page, use "Scan" to assign DALI short addresses to 12 lamps.

DALI A		Reinstall	Scan	Partial download	Full download				
Installation	Groups	Scenes	Flag	ECG NO.	ECG Description	Addr	Type	Group NO.	Group Description
			<input type="radio"/>	ECG 1				G1	
			<input type="radio"/>	ECG 2				G1	
			<input type="radio"/>	ECG 3				G1	
			<input type="radio"/>	ECG 4				G1	
			<input type="radio"/>	ECG 5				G1	
			<input type="radio"/>	ECG 6				G1	
			<input type="radio"/>	ECG 7				G1	
			<input type="radio"/>	ECG 8				G1	
			<input type="radio"/>	ECG 9				G1	
			<input type="radio"/>	ECG 10				G1	
			<input type="radio"/>	ECG 11				G1	
			<input type="radio"/>	ECG 12				G1	
			<input type="radio"/>	ECG 13					
			<input type="radio"/>	ECG 14					

Then, the 12 lamps A0~A11 are associated and paired with ECG 1~ECG 12, and the grouping operation was also completed.

DALI A						
Installation	Flag	ECG NO.	ECG Description	Addr	Type	Group NO.
Groups	plan	ECG 1		A0	Multi	G1
Scenes	plan	ECG 2		A1	Multi	G1
DALI B						
Installation	plan	ECG 3		A2	Multi	G1
Groups	plan	ECG 4		A3	Multi	G1
Scenes	plan	ECG 5		A4	Multi	G1
	plan	ECG 6		A5	Multi	G1
	plan	ECG 7		A6	Multi	G1
	plan	ECG 8		A7	Multi	G1
	plan	ECG 9		A8	Multi	G1
	plan	ECG 10		A9	Multi	G1
	plan	ECG 11		A10	Multi	G1
	plan	ECG 12		A11	Multi	G1

Step 8: On the DCA page, use "Full download" to download all DALI parameters to the lamps and devices.

DALI A						
Installation	Flag	ECG NO.	ECG Description	Addr	Type	Group NO.
Groups	plan	ECG 1		A0	Multi	G1
Scenes	plan	ECG 2		A1	Multi	G1

Step 9: Please ensure that "A: G1" is "On". If not, you can use Object "[A: G1] On/Off" or "[A: G1] Relative Dimming" or "[A: G1] Absolute Dimming" to light up the lamps in the group.

Step 10: Please send commands in the following order (①—> ②), otherwise the HCL function cannot be enabled normally.

- ① Object "[A: G1] Activate HCL colour function/Status" sends "Enable" command.
- ② Object "[DALIA] HCL 24h Curve" sends "On" command.

Note: If you set the parameter "State after KNX power recovery" to "enable", it means that Object "[A: G1] Activate HCL colour function/Status" has already sent the "Enable" command, then you only need Object "[DALIA] HCL 24-hour Curve" to send the "On" command to enable the HCL function.

State after KNX power recovery

4.2.4.3 DIM2WARM SETTING

DIM2WARM SETTING

Limit proportional range	<input checked="" type="checkbox"/>
Lower brightness limit	<input type="text" value="20%"/>
Upper brightness limit	<input type="text" value="80%"/>
Limit colour temperature range	<input checked="" type="checkbox"/>
Minimum colour temperature	<input type="text" value="2700"/> K
Maximum colour temperature	<input type="text" value="4500"/> K
Activate Dim2Warm object	<input checked="" type="checkbox"/>

The chart shows the dynamic range for this parameter:

ETS-text	Dynamic range [default value]	Comment
Limit proportional range	<ul style="list-style-type: none"> ● no check ● check 	<p>Use this parameter to limit the scale range, which is the range of linear dependence between brightness and colour temperature.</p> <ul style="list-style-type: none"> ● No check: No limit on the scale range. ● Check: The proportion range is limited by the upper and lower brightness limits. Between these limitations, the colour temperature varies proportionally with brightness. Below or above the limit, the system uses the minimum or maximum colour temperature respectively.
Lower brightness limit	<ul style="list-style-type: none"> ● 0-99% [20%] 	<p>Set the lower brightness limit. Below this brightness, the colour temperature remains unchanged. Above this brightness, the colour temperature changes proportionally to the brightness.</p>
Upper brightness limit	<ul style="list-style-type: none"> ● 0.4-100% [80%] 	<p>Set the upper brightness limit. Above this brightness, the colour temperature remains unchanged. Below this brightness, the colour temperature changes proportionally to the brightness.</p>

The chart shows the dynamic range for this parameter:

ETS-text	Dynamic range [default value]	Comment
Limit colour temperature range	<ul style="list-style-type: none"> ● no check ● check 	<p>This parameter limits the range of colour temperature and reduces the proportional range of linear dependence between colour temperature and brightness.</p> <ul style="list-style-type: none"> ● No check: No limit on colour temperature. The colour temperature range is completely specified by the minimum and maximum colour temperatures. ● Check: Colour temperature has additional limitations on the Dim2Warm function.
Minimum colour temperature	<ul style="list-style-type: none"> ● 100-10000K [2700K] 	<p>The lowest colour temperature within the Dim2Warm colour temperature range.</p>
Maximum colour temperature	<ul style="list-style-type: none"> ● 1000-10000K [4500K] 	<p>The highest colour temperature within the Dim2Warm colour temperature range.</p>

ETS-text	Dynamic range [default value]	Comment
Activate Dim2Warm object	<ul style="list-style-type: none"> ● no check ● check 	<p>Use this parameter to activate the 'Activate Dim2Warm colour function' object. This object automatically activates or disables the Dim2Warm function.</p> <ul style="list-style-type: none"> ● no check: Do not activate the "Activate Dim2Warm colour function" group object. ● check: Activate the "Activate Dim2Warm colour function" group object. This group object controls all groups.

The following chart shows the objects that belong to DALI A.

Num	Object name	Length	Description
23	[Dali A] Activate automatic Dim2Warm colour function	1 bit	If 'Enable activate Dim2Warm object' is set to 'check', then the object is enabled. This object is used to activate or disable the automatic Dim2Warm colour function. The value of the telegram: 1=activate the automatic Dim2Warm colour function; 0= Disable the automatic Dim2Warm colour function

4.2.5 A:DT1 Rest/Inhibit functions

The rest mode of emergency lights refers to the state in which they are turned off during the operation of emergency lighting. The suppression mode is a timed state (15 minutes). In this state, when the power grid voltage fails, the emergency light does not switch to the emergency operation state. In these two modes, the emergency light no longer performs its safety function, but remains turned off. Note: This function should be used with caution. If the power supply needs to be frequently turned off during the construction phase, using the "Rest/Inhibit" mode can help prevent the battery in the emergency light from constantly charging or discharging, thereby improving the service life of the emergency light.

The screenshot shows a configuration window with a sidebar on the left and a main panel on the right. The sidebar has a tree view with the following items:

- + General
- DALI A Configuration
 - A:ECGs enable
 - A:Groups enable
 - A:Broadcast enable
 - A:HCL/Dim2Warm functions
 - A:DT1 Rest/Inhibit functions** (highlighted in blue)
- + DALI B Configuration

The main panel displays the configuration for the selected 'A:DT1 Rest/Inhibit functions' section, titled 'REST/INHIBIT MODE'. It contains the following settings:

- Enable rest mode:
- Automatically exit rest mode after: 8 Hours (dropdown menu)
- Send status message rest mode:
- Send object value: at change (dropdown menu)
- Enable inhibit mode:
- Automatically exit inhibit mode after: 8 Hours (dropdown menu)
- Send status message inhibit mode:
- Send object value: at change (dropdown menu)

The chart shows the dynamic range for this parameter:

ETS-text	Dynamic range [default value]	Comment
Enable rest mode	<ul style="list-style-type: none"> ● no check ● check 	Whether to activate the "Activate Rest Mode" object
Automatically exit rest mode after	<ul style="list-style-type: none"> ● 0-48h [8h] 	This parameter defines the duration of the emergency lighting converter in rest mode. During this period, the emergency lighting function will not be activated. In the event of grid voltage failure, the emergency lighting converter does not turn on emergency lighting. Note: The DLC-02-KN gateway repeats the DALI rest command to the emergency lighting converter approximately every 5 minutes.
Send status message rest mode	<ul style="list-style-type: none"> ● no check ● check 	Whether to activate the "Send status message rest mode".

ETS-text	Dynamic range [default value]	Comment
Send object value	<ul style="list-style-type: none"> ● no send, passive state object ● at change ● always at input of telegram 	Set the condition options for sending "On/Off (Status)" messages.
Enable inhibit mode	<ul style="list-style-type: none"> ● no check ● check 	Whether to activate the "Activate Inhibit Mode" object.
Automatically exit inhibit mode after	<ul style="list-style-type: none"> ● 0-48h [8h] 	This parameter defines the duration of the emergency lighting converter in inhibit mode. During this period, the emergency lighting function will not be activated. In the event of grid voltage failure, the emergency lighting converter does not turn on emergency lighting. Note: The DLC-02-KN gateway repeats the DALI rest command to the emergency lighting converter approximately every 5 minutes.
Send status message inhibit mode	<ul style="list-style-type: none"> ● no check ● check 	Whether to activate the "Send status message inhibit mode".
Send object value	<ul style="list-style-type: none"> ● no send, passive state object ● at change ● always at input of telegram 	Set the condition options for sending "On/Off (Status)" messages.

5.DALI Commissioning

Following the physical installation and wiring of the DALI ECGs and lamps and the electronic commissioning, the connected ECGs need to be learnt-in.

Before opening the DCA interface to scan the device, you need to assign the KNX physical address first. Only after the address is assigned and the database is downloaded to the DLC-02-KN can you start operations such as firmware upgrade, DALI scanning, parameter downloading, and DALI testing. Otherwise, two types of error messages as shown in the following figure will appear.

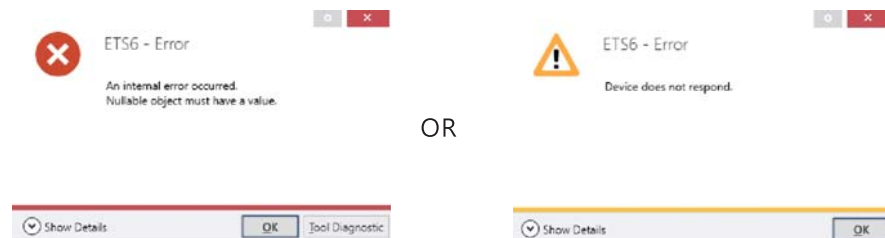

After downloading the database, please open the DCA communication interface and configure DALI related parameters here.

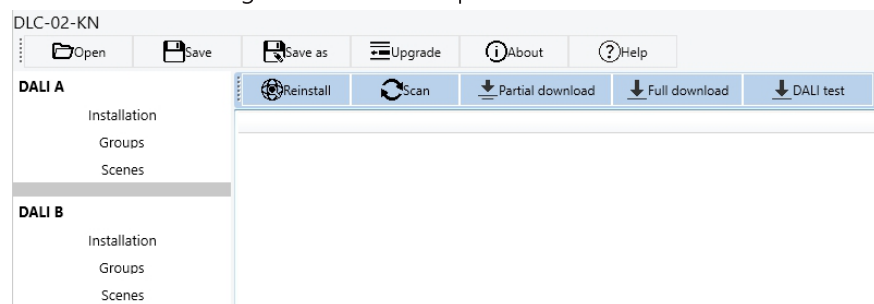

5.1 Menu



- (1)Open : Open an existing project file and display configuration information
- (2)Save : Save the current configuration information to the project file
- (3)Save as : Save the current configuration information as a new project file
- (4)Upgrade : MEAN WELL will continue to optimize and enhance the application functions of DLC-02-KN, allowing system developers and end users to have a more convenient user experience. New firmware files can be downloaded to the product through the "Upgrade" function to obtain the latest features

User may find the latest firmware files from below link.
https://www.meanwell.com/upload/PDF/KNX/DLC-02-KN/DLC-02-KN_log.pdf

After clicking 'Upgrade', a new window will appear where you can complete the firmware upgrade of KNX MCU and DALI MCU

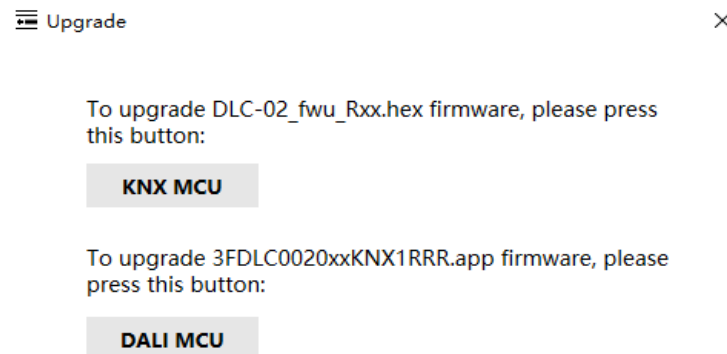

KNX MCU upgrade window :

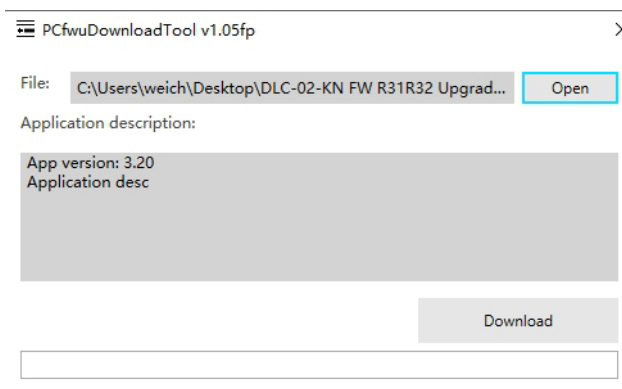

DALI MCU upgrade window. Note: When upgrading DALI MCU, the USB cable needs to be connected to the USB port of DLC-02-KN.

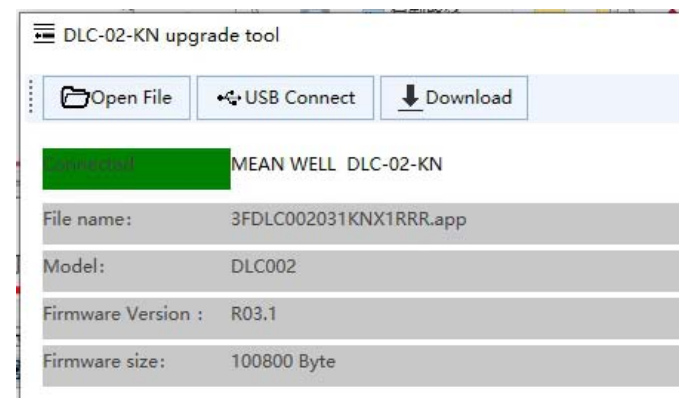

(5) About : Display ETS APP version and other information of DLC-02-KN

(6) Help : Quickly link to the product manual

5.2 DALI Operation interface

Through this interface, you can first configure the group and scene of virtual lamps off-line (Other DALI parameters can be configured in the ETS interface, see Chapter 4 for details), and create project files. When installing on site, the actual lamps and virtual lamps can be paired through DALI addressing, and then the pre created project files can be imported into the site for use through the "download" operation.

In addition, you can also test lamps, groups, and scenes online, as well as change the DALI short address of lamps.

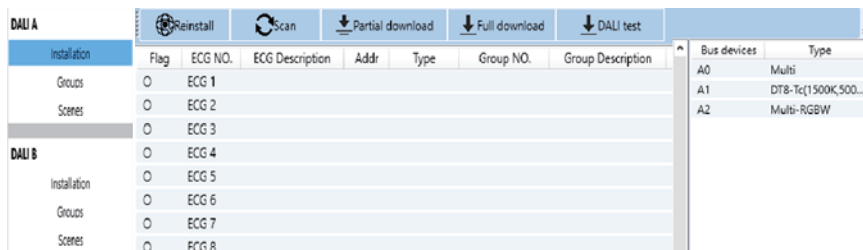

5.2.1 DALI Addressing and Parameter Download

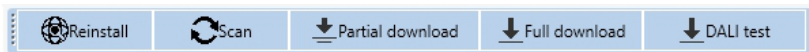

(1) DALI Addressing

Use the "Reinstall" or "Scan" buttons to start scanning for devices and assign addresses. The scanned devices will be displayed in the far right area

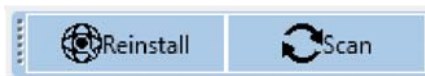

During this process, all ECGs are automatically recognized, and each ECG is assigned a short address from 0 to 63, which may take several minutes. As shown in the figure below, there are 3 ECGs (short addresses: A0~A2) on the DALI A bus

Bus devices	Type
A0	Multi
A1	DT8-Tc(1500K,500...
A2	Multi-RGBW

Note: During the first installation, "Scan" and "Reinstall" make a no difference in searching devices and addressing. After an installation, the "Scan" button carries out a search for previously addressed and unaddressed devices. Address for previously addressed devices will remain unchanged. The next available address is then assigned to devices which have been recently added, whereas "Reinstall" removes all addresses and then re-addresses them randomly.

(2) Parameter download

All parameter configurations (including groups, scenes, etc.) are only displayed in the workspace and will not be immediately loaded into the DALI gateway. To download the configuration to the gateway and ECGs, press the "Partial download" or "Full download" button

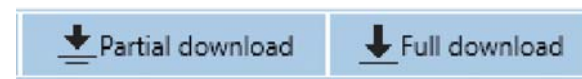

Partial download : Only download the data of the changed ECG and Group to the gateway

Full download : Download the data of all ECG and Group to the gateway

Note : Please be aware that the download on the DCA interface only programs the DALI configuration data to the gateway and ECGs. The ETS application with parameter settings and group addresses still needs to be downloaded to the device. This is done, as usual, via the normal download process in the ETS.

(3) DALI test

On the DALI test interface, users can quickly test the brightness, colour temperature, and colour effects of online lamps. Before using the DALI test, please scan the online lamps and assign addresses via the "Scan" or "Reinstall" function.



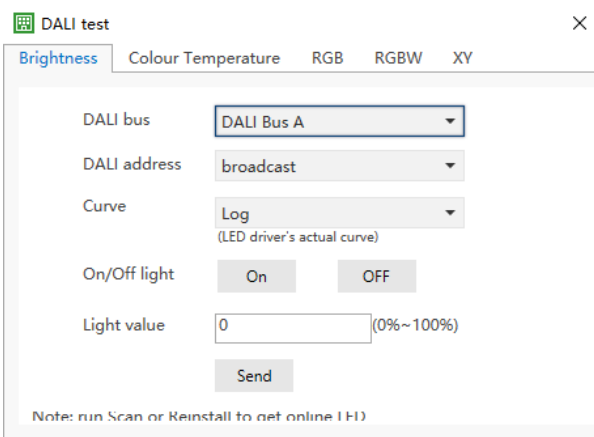

The following table shows the description of the relevant parameters:

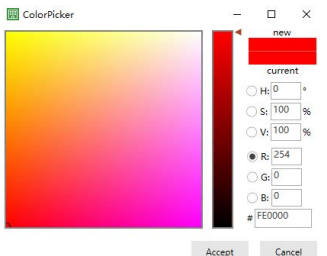
Parameter	Description
Brightness type	
DALI bus	Select the DALI bus. (DALI Bus A or DALI Bus B)
DALI address	Select the address of the lamp to be tested. (broadcast or A0~A63 or B0~B63)
Curve	The actual dimming curve type of the lamp to be tested. (Log or Linear)
On/Off light	Turn-on or turn-off the lamp. (On: 100%; Off: 0%)
Light value	Set the brightness value. (0%, 1%, ..., 99%, 100%)
Send	Execute the DALI instruction.
Colour Temperature type	
Tc value	Set the colour temperature value. (1000~10000K)
RGB type	
Colour value	Set the colour. (RGB Colour Picker) 

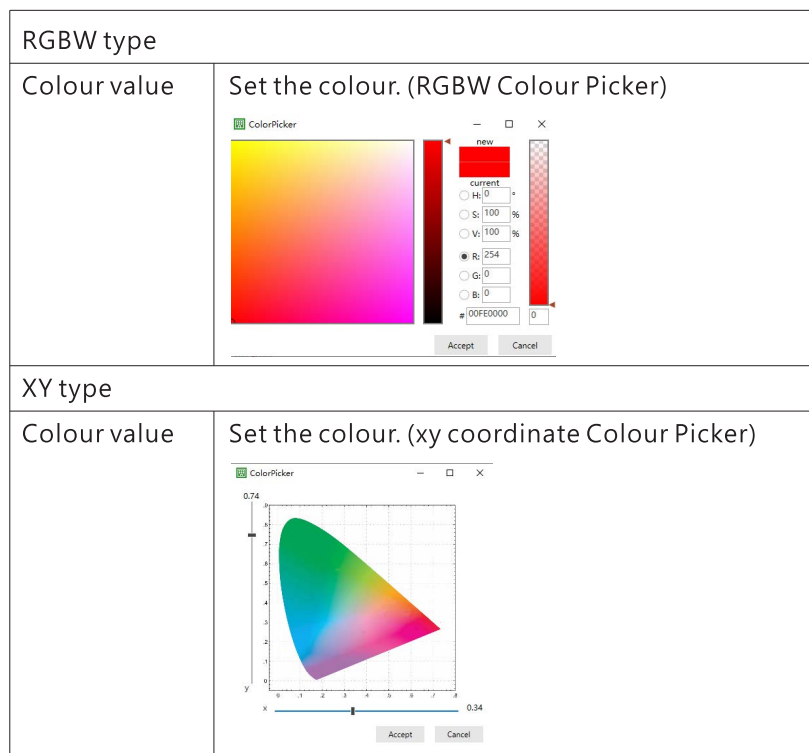

5.2.2 DALI Bus

The parameter configuration method for DALI A and DALI B buses is the same. The following detailed explanation will take the DALI A bus as an example

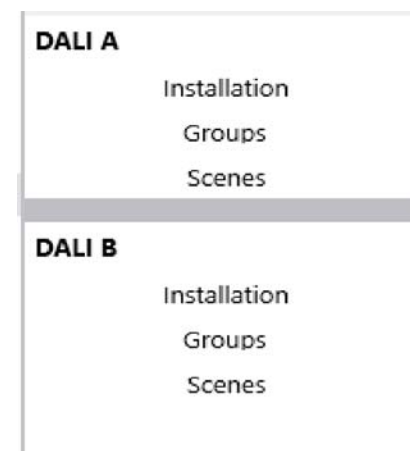

5.2.2.1 DALI A-Installation

(1) As shown in the following figure, the "allocation area" shows that 64 ECGs can be connected on the DALI bus, and the "Waiting area" shows the addressed light fixtures (A0~A2)

Flag	ECG NO.	ECG Description	Addr	Type	Group NO.	Group Description	Bus devices	Type
○	ECG 1						A0	Multi
○	ECG 2						A1	DT8-Tc(1500K,500...
○	ECG 3						A2	Multi-RGBW
○	ECG 4							
○	ECG 5							
○	ECG 6							
○	ECG 7							
○	ECG 8							

Allocation area

Waiting area

The following table shows the description of the relevant parameters

Parameter	Description
ECG NO.	Display the number of the ECG (ECG1~ECG64)
ECG Description	Display the name of the ECG. This name can be edited on the "Parammers" interface of ETS
Addr	Display the DALI short address of the ECG(A0~A63)
Type	Display the type of the ECG
Group NO.	Display the group in which the ECG is located(G1~G16)
Group Description	Display the name of the group where the ECG is located

In the "Waiting area", select the addressed lamp and right-click to perform online on/off and flashing tests

Bus devices	Type
A0	Mult
A1	DT8-
A2	Mult
	On
	Off
	Blink
	Broadcast On
	Broadcast Off

(2) In the "Waiting area", select a lamp and hold down the left mouse button to move it to the "Allocation Area" and complete address pairing with any ECG.After pairing, the default state of the lamp is OFF. If you want to cancel ECG pairing, simply move it back to the "Waiting area".

Flag	ECG NO.	ECG Description	Addr	Type	Group NO.	Group Description	Bus devices	Type
plan	ECG 1		A1	DT8-Tc(1500K,500...			A0	Multi
plan	ECG 2		A2	Multi-RGBW				
○	ECG 3							
○	ECG 4							
○	ECG 5							
○	ECG 6							
○	ECG 7							
○	ECG 8							

Allocation area

Waiting area

Select the paired lamp and right-click. Not only can you perform on/off and flashing tests online, but you can also modify its DALI short address

Flag	ECG NO.	ECG Description	Addr	Type	Group NO.	Group Description
plan	ECG 1		A1	DT8-Tc(1500K,500...		
plan	ECG 2		A2	Multi-RGBW		
○	ECG 3					
○	ECG 4					
○	ECG 5					
○	ECG 6					
○	ECG 7					
○	ECG 8					

- Command 1 : On
Set the brightness of the lamp to maximum
- Command 2 : Off
Turn off the lamp
- Command 3 : Blink
The lamp flashes repeatedly, with an interval of 1 second
- Command 4 : Set Short Address
Reset the short address of the lamp

5.2.2.2 DALI A-Groups

(1) Each DALI bus can be configured with 16 groups, and selecting one group can view its member information.

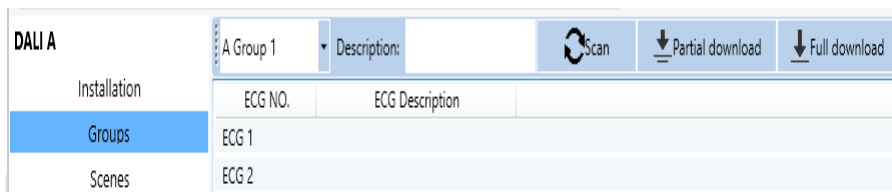

The following table shows the description of the relevant parameters

Parameter	Description
A Group n	The group of DALI A bus:Group 1~16.
Description.	Set the name of the scene. The maximum character length is 30 bits.
ECG NO.	Display the number of the ECG
ECG Description	Display the name of the ECG (the ECG name is set on the "Parameters" page)

(2) There are 64 virtual lamps that can be grouped within the 'waiting area'. Select one of the lamps and hold down the left mouse button to move it to the "grouping area", thus completing the grouping operation of the lamps. If you want to cancel the grouping of lamps, simply move them back to the "waiting area".

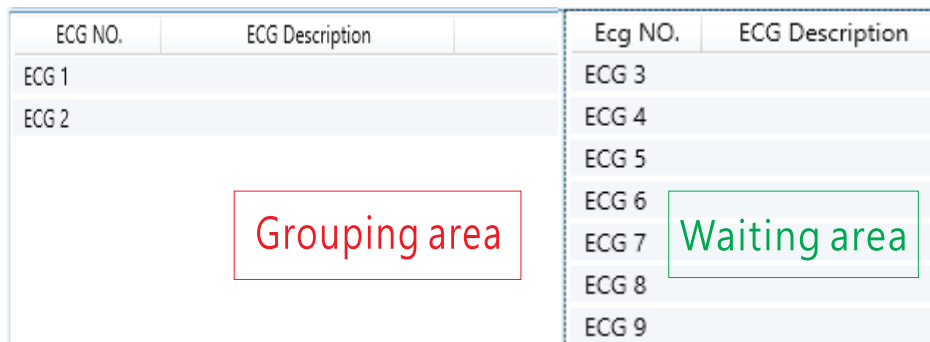

(3) After grouping, please click on the "Partial download" or "Full download" button to download the grouping information to the gateway and ECGs. After downloading, click the right mouse button to perform lamp on, lamp off, and flashing tests on the group.

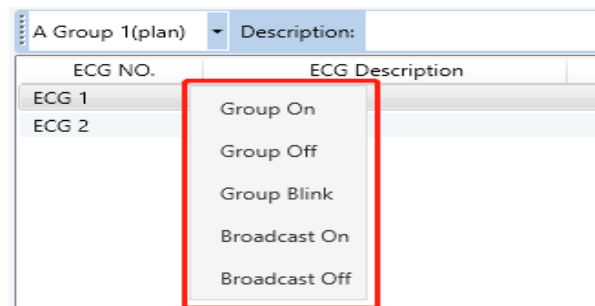

Command 1 : Group On

Set the brightness of all lamps in this group to maximum

Command 2 : Group Off

Turn off all lamps in this group

Command 3 : Group Blink

Cycle all lamps in the group to flash, with an interval of 1 second

Command 4 : Broadcast On

Set the brightness of all lamps on the corresponding DALI bus to maximum

Command 5 : Broadcast Off

Turn off all lamps on the corresponding DALI bus

5.2.2.3 DALI A-Scenes

(1) Each DALI bus can be configured with 16 scenes. After selecting one of the scenes, all lamps or groups assigned to that scene will be displayed. In this interface, you can set the scene brightness, colour, and fade time for lamps or groups, and also test the scene online.

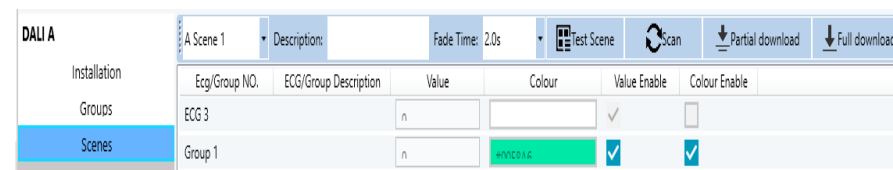

The following table shows the description of the relevant parameters

Parameter	Description
A Scene n	The scene of DALI A bus:Scene 1~16
Description.	Set the name of the scene. The maximum character length is 30 bits
Fade Time	Display the fade time of the scene
Test Scene	Scene testing

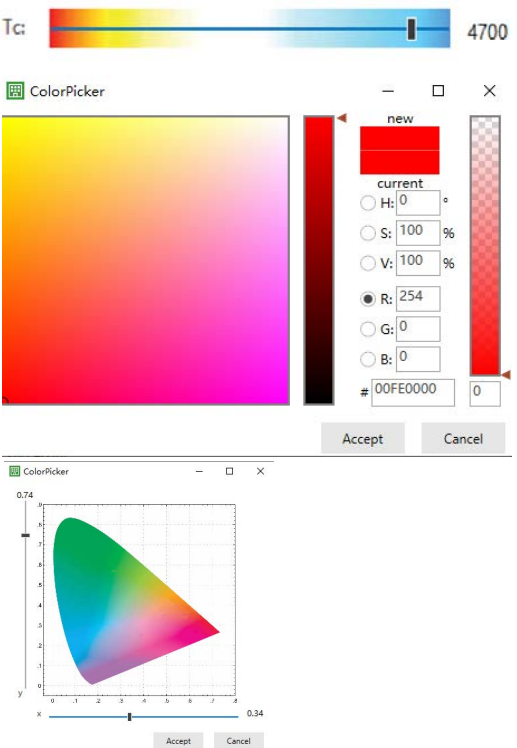
ECG/Group NO.	Display the ECG or group number.
ECG/Group Description.	Display the name of the ECG or group. (The ECG name is set through the "Parameters" page. The Group name is set the "Groups" page in DCA)
Value	Display the brightness of the scene, with values ranging from 0, 1, 2, 100%). Only when 'Value Enable' is checked will it take effect
Colour	<p>Double clicking here will pop up a colour temperature bar or colour wheel, which is used to set the colour or colour (RGB/xy coordinates) for the scene. Only when 'Colour Enable' is checked will it take effect</p> 
Value Enable	Whether to activate the brightness level setting function
Colour Enable	Whether to activate the colour setting function. It will only take effect when the control type of ECG or Group is DT8 (Colour Temperature/RGB/RGBW/xy coordinate). The control types of ECG and Group are set through the "Parameters" page

(2) In the "waiting area", there are 64 virtual lamps and 16 groups that can be assigned scenes. Select one of the lamps or groups and press and hold the left mouse button to move it to the "allocation area", thus completing the scene allocation. If you want to cancel the scene, simply move it back to the 'waiting area

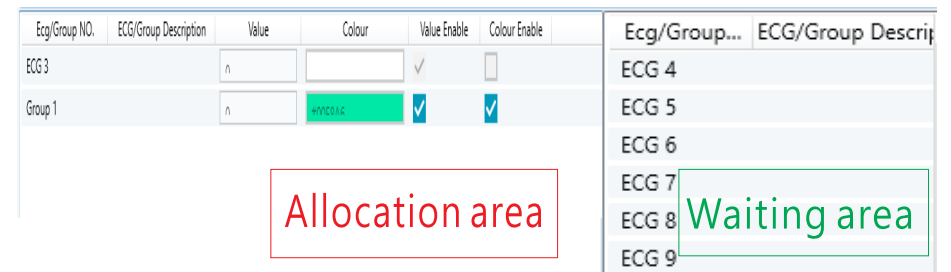

(3) After setting the scene, please click on the "Partial download" or "Full download" button to download the scene information to the gateway and ECGs. After downloading, click the right mouse button to trigger the scene effect online

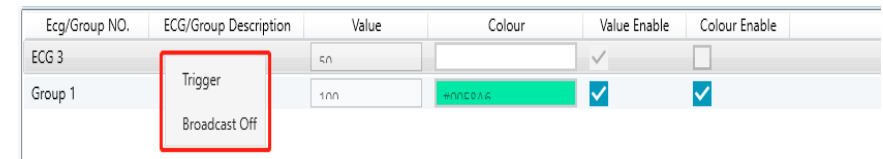

Command 1 : Trigger

The corresponding scene is triggered

Command 2 : Broadcast Off

Turn off all lamps on the corresponding DALI bus

6.Communication Objects

Communication objects available for communication of the device via the KNX are shown in the table below. The objects are, in parts, displayed or hidden, depending on how the parameters are set

6.1 Summary and Usage

Num	Object name	Length	DPT	Flag	Function	Description
1	[Dali A] Broadcast Switch	1bit	Switch (DPT 1.001)	CW	On/Off	DALI Bus A - Broadcast Switch. This object is used to switch all connected lamps simultaneously on or off
2	[Dali A] Broadcast Absolute Dimming	1 byte	percentage (DPT 5.001)	CW	Absolute Dimming	DALI Bus A - Broadcast Absolute Dimming. This object is used to simultaneously set all connected lamps to a certain brightness.
3	[Dali A] Broadcast Colour Temperature	2 bytes	absolute colour temperature(K) (DPT 7.600)	CW	Colour Temperature Setting	DALI Bus A -Broadcast Colour Temperature. This object is used to simultaneously set all connected colour temperature lamps to a certain colour temperature.This operation will disable all 'Activate HCL color functions' and 'Activate Dim2Warm color functions'
4	[Dali A] Broadcast Colour RGB	3 bytes	RGB value 3x (DPT232.600)	CW	Colour RGB Setting	DALI Bus A -Broadcast Colour RGB. This object is used to simultaneously set all connected RGB lamps to a certain colour
	[Dali A] Broadcast Colour RGBW	6 bytes	RGBW value 4x (DPT251.600)	CW	Colour RGBW Setting	DALI Bus A -Broadcast Colour RGBW. This object is used to simultaneously set all connected RGBW lamps to a certain colour.

Num	Object name	Length	DPT	Flag	Function	Description
	[Dali A] Broadcast Colour xy-coordinate	6 bytes	colour xy-coordinate (DPT242.600)	CW	Colour xy-coordinate Setting	DALI Bus A -Broadcast Colour xy-coordinate. This object is used to simultaneously set all connected xy-coordinate lamps to a certain colour.
5	[Dali A] Broadcast Scene	1 byte	scene number (DPT 18.001)	CW	Scene No.(1...16)	Dali A bus scene control, which can be configured in the DCA page. Note: 1. Activating the scene will disable all "Activate HCL colour functions" and "Activate Dim2Warm colour functions"2. After using the scene function, do not use the "download" function in the DCA page again, otherwise the scene setting information will be overwritten.
6	[Dali A] Activate Panic Mode	1bit	start/stop (DPT 1.010)	CW	Activate/ Stop	DALI Bus A - Panic mode. Activates or deactivates the panic mode via the bus. This object is only valid when the parameter "Panic mode" of the ECG or Group is checked. Note: Priority: Panic mode > Lock > Night mode.
7	[Dali A] Activate Night Mode	1 bit	start/stop (DPT 1.010)	CW	Activate/ Stop	DALI Bus A - Night mode. Activates or deactivates the night mode via the bus. This object is only valid when the parameter "Night mode" of the ECG or Group is checked. Note: Priority: Panic mode > Lock > Night mode.

Num	Object name	Length	DPT	Flag	Function	Description
8	[Dali A] Activate Test Mode	1 bit	start/stop (DPT 1.010)	CW	Activate/ stop	Activate the test mode on the Dali A bus. When the parameter "Emergency Luminaire with Central Battery" in ECG is selected as "Central Battery Emergency Luminaire", the ECG responds to the test mode
9	[Dali A] Activate Rest Mode	1 bit	start/stop (DPT 1.010)	CW	Activate/ stop	Activate/stop the rest mode on the Dali A bus
10	[Dali A] Activate Inhibit Mode	1 bit	start/stop (DPT 1.010)	CW	Activate/ stop	Activate/stop the inhibit mode on the Dali A bus.
11	[Dali A] Dali Short Circuit	1 bit	alarm (DPT 1.005)	CRT	0 = No Error;1 = Error	Reports the presence of a DALI short-circuit in the connected DALI segment. When bus A is short-circuit, the object sends '1', otherwise it sends '0'.
12	[Dali A] ECG Presence	1 bit	alarm (DPT 1.005)	CRT	0 = No Error;1 = Error	Reports the presence of a ECG disconnect in the connected DALI segment. When at least one ECG on bus A is disconnected, the object sends '1', otherwise it sends '0'
13	[Dali A] ECG Diagnostics	1byte	diagnostics value (DPT 238.600)	CRT	ECG Diagnostics	This object is used to send the error status of lamp or ECG errors in the DALI bus A when the system is started or when a change has taken place. Bit 0-5 refer to the number of the ECG, range from 0-63. Bit 6 represents a lamp error. Bit 7 represents an ECG error.0 = no error; 1 = error

Num	Object name	Length	DPT	Flag	Function	Description
14	[Dali A] On/Off (Status Group1 Group16)	4 bytes	bit-combined info on/off (DPT 27.001)	CRT	Status	Sends the on/off status for groups 1- 16. Bit 0-15 refer to Group 1 to Group 16. For example: Grp.16 15 14 13... 3 2 1 Bit 15 14 13 12... 3 2 1 0 Group 3 on: 0 0 0 0 0 0 0 0 0 0 0 0 1 0 0
15	[Dali A] On/Off (Status ECG1-ECG16)	4 bytes	bit-combined info on/off (DPT 27.001)	CRT	Status	Sends the on/off status for ECGs 1-16. Bit 0-15 refer to ECG 1 to ECG 16. For example: ECG.16 15 14 13... 3 2 1 Bit 15 14 13 12... 3 2 1 0 ECG 3 on:0 0 0 0 0 0 0 0 0 0 0 1 0 0
16	[Dali A] On/Off (Status ECG 17-ECG32)	4 bytes	bit-combined info on/off (DPT 27.001)	CRT	Status	Sends the on/off status for ECGs 17-32. Bit 0-15 refer to ECG 17 to ECG 32
17	[Dali A] On/Off (Status ECG 33-ECG48)	4 bytes	bit-combined info on/off (DPT 27.001)	CRT	Status	Sends the on/off status for ECGs 33-48. Bit 0-15 refer to ECG 33 to ECG 48
18	[Dali A] On/Off (Status ECG 49-ECG64)	4 bytes	bit-combined info on/off (DPT 27.001)	CRT	Status	Sends the on/off status for ECGs 49-64. Bit 0-15 refer to ECG 49 to ECG 64
19	[Dali A] Standby Switch-off	1 bit	switch (DPT 1.001)	CW	Standby Switch-off	If 'Standby switch off' is set to 'check', then the object is enabled. This object sends "0" when the standby condition is satisfied, and "1" when the standby condition is released
20	[Dali A] Enable/ Disable standby Switch-off	1 byte	enable (DPT 1.003)	CW	0=Disable; 1=Enable	Enable or disable "Standby switchoff" function. When "Standby switchoff" is not enabled, object 19 [DALI A] Standby Switch-off will send "1"

Num	Object name	Length	DPT	Flag	Function	Description
21	[Dali A] HCL Colour Temperature	2 bytes	absolute colour temperature(K) (DPT 7.600)	CW	HCL Colour Temperature Setting	Enable this object when 'HCL colour temperature source' is set to 'HCL colour temperature (2-bytes object)'. This object is used to control the colour temperature value of HCL
	[Dali A] HCL ramp up/down	1 bit	up/down (DPT 1.008)	CW	0=Up; 1=Down	When the "HCL color temperature source" is set to "Ramp curve (1-bit object)," this object is enabled. This object triggers the HCL slope curve. The telegram values are: 0=start rising slope; 1=start descending slope
	[Dali A] HCL 24h Curve	1 bit	switch (DPT1.001)	CW	0=Off; 1=On	When the "HCL colour temperature source" is set to "HCL 24-hour Curve (1-bit object), enable this object to trigger the HCL 24-hour Curve function
22	[Dali A] Activate automatic HCL colour function	1 bit	enable (DPT1.003)	CW	0=Disable; 1=Enable	If 'Enable activate HCL object' is set to 'check', then the object is enabled. This object activates or disables the automatic HCL colour function. The value of the telegram: 1=Activate the automatic HCL colour function; 0=Disable the automatic HCL colour function

Num	Object name	Length	DPT	Flag	Function	Description
23	[Dali A] Activate automatic Dim2Warm colour function	1 bit	enable (DPT 1.003)	CW	0=Disable; 1=Enable	If 'Enable activate Dim2Warm object' is set to 'check', then the object is enabled. This object is used to activate or disable the automatic Dim2Warm colour function. The value of the telegram: 1=activate the automatic Dim2Warm colour function; 0= Disable the automatic Dim2Warm colour function
24	[Dali B] Broadcast Switch	1 bit	switch (DPT 1.001)	CW	On/Off	DALI Bus B - Broadcast Switch. This object is used to switch all connected lamps simultaneously on or off
25	[Dali B] Broadcast Absolute Dimming	1 byte	percentage (DPT 5.001)	CW	Absolute Dimming	DALI Bus B - Broadcast Absolute Dimming. This object is used to simultaneously set all connected lamps to a certain brightness.
26	[Dali B] Broadcast Colour Temperature	2 bytes	absolute colour temperature(K) (DPT 7.600)	CW	Colour Temperature Setting	DALI Bus B - Broadcast Colour Temperature. This object is used to simultaneously set all connected colour temperature lamps to a certain colour temperature. This operation will disable all 'Activate HCL color functions' and 'Activate Dim2Warm color functions'.

Num	Object name	Length	DPT	Flag	Function	Description
27	[Dali B] Broadcast Colour RGB	3 bytes	RGB value 3x (DPT232.600)	CW	Colour RGB Setting	DALI Bus B-Broadcast Colour RGB.This object is used to simultaneo- usly set all connected RGB lamps to a certain colour.
	[Dali B] Broadcast Colour RGBW	6 bytes	RGBW value 4x (DPT251.600)	CW	Colour RGBW Setting	DALI Bus B-Broadcast Colour RGBW.This object is used to simultaneously set all connected RGBW lamps to a certain colour.
	[Dali B] Broadcast Colour xy-coordinate	6 bytes	colour xy-coordinate (DPT242.600)	CW	Colour xy-coordinate Setting	DALI Bus B -Broadcast Colour xy-coordinate. This object is used to simultaneously set all connected xy-coordinate lamps to a certain colour
28	[Dali B] Broadcast Scene	1 byte	scene number (DPT 18.001)	CW	Scene No.(1...16)	Dali B bus scenario control, which can be configured in the DCA page. Note: 1. Activating the scene will disable all "Activate HCL colour functions" and "Activate Dim2Warm colour functions" 2. After using the scene function, do not use the "download" function in the DCA page again, otherwise the scene setting information will be overwritten.

Num	Object name	Length	DPT	Flag	Function	Description
29	[Dali B] Activate Panic Mode	1 bit	start/stop (DPT 1.010)	CW	Activcate/ stop	DALI Bus B-Panic mode Activates or deactivates the panic mode via the bus. This object is only valid when the parameter"Panic mode" of the ECG or Group is checked. Note: Priority: Panic mode > Lock > Night mode.
30	[Dali B] Activate Night Mode	1 bit	start/stop (DPT 1.010)	CW	Activate/ Stop	DALI Bus B-Night mode Activates or deactivates the night mode via the bus. This object is only valid when the parameter"Night mode" of the ECG or Group is checked. Note: Priority: Panic mode > Lock > Night mode.
31	[Dali B] Activate Test Mode	1 bit	start/stop (DPT 1.010)	CW	Activate/ Stop	Activate the test mode on the Dali B bus. When the parameter "Emergency Luminaire with Central Battery" in ECG is selected as " Central Battery Emergency Luminaire", the ECG responds to the test mode.
32	[Dali B] Activate Rest Mode	1 bit	start/stop (DPT 1.010)	CW	Activate/ Stop	Activate/stop the rest mode on the Dali B bus
33	[Dali B] Activate Inhibit Mode	1 bit	start/stop (DPT 1.010)	CW	Activate/ Stop	Activate/stop the inhibit mode on the Dali B bus
34	[Dali B] Dali Short Circuit	1 bit	alarm (DPT 1.005)	CRT	0=No Error; 1=Error	Reports the presence of a DALI short-circuit in the connected DALI segment. When bus B is short-circuit, the object sends '1', otherwise it sends '0'.

Num	Object name	Length	DPT	Flag	Function	Description
35	[Dali B] ECG Presence	1 bit	alarm (DPT 1.005)	CRT	0=No Error; 1=Error	Reports the presence of a ECG disconnect in the connected DALI segment. When at least one ECG on bus B is disconnected, the object sends '1', otherwise it sends '0'.
36	[Dali B] ECG Diagnostics	1byte	diagnostics value (DPT 238.600)	CRT	ECG Diagnostics	This object is used to send the error status of lamp or ECG errors in the DALI bus B when the system is started or when a change has taken place. Bit 0-5 refer to the number of the ECG, range from 0 -63. Bit 6 represents a lamp error. Bit 7 represents an ECG error 0 = no error; 1 = error
37	[Dali B] On/Off (Status Group1- Group16)	4 bytes	bit-combin ed info on/off (DPT 27.001)	CRT	Status	Sends the on/off status for groups 1-16. Bit 0 -15 refer to Group 1 to Group 16. For example: Grp.16 15 14 13 ... 3 2 1 Bit 15 14 13 12 ... 3 2 1 0 Group 3 on: 0 0 0 0 0 0 0 0 0 0 0 0 1 0 0
38	[Dali B] On/Off (Status ECG1- ECG16)	4 bytes	bit-combin ed info on/off (DPT 27.001)	CRT	Status	Sends the on/off status for ECGs 1-16. Bit 0-15 refer to ECG 1 to ECG16 For example: ECG.16 15 14 ... 3 2 1 Bit 15 14 13 12 ... 3 2 1 0 ECG 3 on: 0 0 0 0 0 0 0 0 0 0 0 0 1 0 0
39	[Dali B] On/Off (Status ECG17- ECG32)	4 bytes	bit-combin ed info on/off (DPT 27.001)	CRT	Status	Sends the on/off status for ECGs 17-32. Bit 0-15 refer to ECG 17 to ECG32

Num	Object name	Length	DPT	Flag	Function	Description
40	[Dali B] On/Off (Status ECG33- ECG48)	4 bytes	bit-combin ed info on/off (DPT 27.001)	CRT	Status	Sends the on/off status for ECGs 33-48. Bit 0-15 refer to ECG 33 to ECG 48
41	[Dali B] On/Off (Status ECG49- ECG64)	4 bytes	bit-combin ed info on/off (DPT 27.001)	CRT	Status	Sends the on/off status for ECGs 49-64. Bit 0-15 refer to ECG 49 to ECG 64
42	[Dali B] Standby Switch-off	1 bit	switch (DPT 1.001)	CW	Standby Switch-off	If 'Standby switch off' is set to 'check', then the object is enabled. This object sends "0" when the standby condition is satisfied, and "1" when the standby condition is released
43	[Dali B] Enable/ Disable Standby Switch-off	1 bit	enable (DPT 1.001)	CW	0=Disable; 1=Enable	Enable or disable "Standby switchoff" function. When "Standby switchoff" is not enabled, object 38 [DALI B] Standby Switch-off will send "1"
44	[Dali B] HCL Colour Temperature	2 bytes	absolute colour temperature (K) (DPT 7.600)	CW	HCL Colour Temperature Setting	Enable this object when 'HCL colour temperature source' is set to 'HCL colour temperature (2-bytes object)'. This object is used to control the colour temperature value of HCL

Num	Object name	Length	DPT	Flag	Function	Description
	[Dali B] HCL ramp up/ down	1 bit	up/down (DPT 1.008)	CW	0=Up; 1=Down	When the "HCL color temperature source" is set to "Ramp curve (1-bit object)," this object is enabled. This object triggers the HCL slope curve. The telegram values are: 0=start rising slope; 1=start descending slope
	[Dali B] HCL 24h Curve	1 bit	switch (DPT 1.001)	CW	0=Off; 1=On	When the "HCL colour temperature source" is set to "HCL 24-hour Curve (1-bit object), enable this object to trigger the HCL 24-hour Curve function
45	[Dali B] Activate automatic HCL colour function	1 bit	enable (DPT 1.003)	CW	0=Disable; 1=Enable	If 'Enable activate HCL object' is set to 'check', then the object is enabled. This object activates or disables the automatic HCL colour function. The value of the telegram: 1=Activate the automatic HCL colour function; 0=Disable the automatic HCL colour function
46	[Dali B] Activate automatic Dim2Warm colour function	1 bit	enable (DPT 1.003)	CW	0=Disable; 1=Enable	If 'Enable activate Dim2Warm object' is set to 'check', then the object is enabled. This object is used to activate or disable the automatic Dim2Warm colour function. The value of the telegram: 1=activate the automatic Dim2Warm colour function; 0= Disable the automatic Dim2Warm colour function

Num	Object name	Length	DPT	Flag	Function	Description
47	[Central Function] operation	1 bit	state (DPT 1.011)	CRT	Operation	When active, this object is use to send status of the device to the system at regular intervals which is set by the parameter "Send operation cyclic"
48	[Central Function] All Relays On/Off	1 bit	switch (DPT 1.001)	CW	0 = Off; 1 = On	This object is use to switch all of the selected relays on/off. Note: The object is valid only when the following requirements are met. (1)The parameter "All Relays On/Off" and "Relay n(n=1~4)control" in "General setting" are checked (2)When "Relay n (n=1~4) control" is checked, there is a submenu called "Relays" in which the parameter "Central function" shall be checked
49	[Central Function] All Relays On/Off (Status)	1 bit	switch (DPT 1.001)	CRT	0 = Off; 1 = On	Sends the on/off status for the relays. 1: all of the selected relays are off. 0: one of the selected relays is on.
50	[Central Function] RTC	3 bytes	time of day (DPT 10.001)	CR	Time	This object is used to set the time of DLC-02-KN, as well as read the time from DLC-02-KN
51	[Central Function] RTC	3 bytes	data (DPT 11.001)	CR	Data	This object is used to set the date of DLC-02-KN, as well as read the date from DLC-02-KN.

Num	Object name	Length	DPT	Flag	Function	Description
52	[Central Function] AC Failure (Status)	1 bit	alarm (DPT 1.005)	CRT	0 = No Error 1 = Error	When the AC power of DLC-02-KN is disconnected, the object sends "1", and when the AC power supply of DLC-02-KN is normal, it sends "0"
53	[A:ECG 1] On/Off	1 bit	switch (DPT 1.001)	CW	0 = Off; 1 = On	Use this object to switch the ECG on or off. The dimming value is set by the parameters "Switch -On value" and "Switch -off value"
	[A:ECG 1] Permanent ON	1 bit	switch (DPT 1.001)	CW	0 = Off; 1 = On	When 'Staircase light' is selected as 'active', enable this object. Telegram value: 1= entering Permanent ON mode; 0=Exit Permanent ON mode
54	[A:ECG 1] Realtive Dimming	4 bit	dimming control (DPT 3.007)	CW	4-Bit Dimming Control	This object is used for the relative dimming of the ECG
55	[A:ECG 1] Absolutely Dimming	1 byte	percentage (DPT 1.001)	CW	1-Byte Dimming Control	This object is used for the absolute dimming of the ECG

Num	Object name	Length	DPT	Flag	Function	Description
56	[A:ECG 1] On/Off (Status)	1 bit	switch (DPT 1.001)	CRT	0 = Off; 1 = On	<p>Sends the on/off status of the ECG.</p> <p>1.The parameter "Send On/Off Status"chooses" no send, passive stage object".→ update status but no send telegram.</p> <p>2.The parameter "Send On/Off Status" chooses" at change" → send telegram in every on/off change.</p> <p>3.The parameter "Send On/Off Status" chooses" always at input of telegram" → send telegram in every on/off command.</p> <p>4. The parameter "Send Status cyclic" is at a certain time value→ send telegram at regular intervals.</p> <p>Note: When dimming value>0, the current state is On, and when dimming value=0, the current state is Off</p>

Num	Object name	Length	DPT	Flag	Function	Description
57	[A:ECG 1] Dimming Value(Stat us)	1 byte	percentage (DPT5.001)	CRT	0 - 100%	Sends the dimming value of the ECG. 1.The parameter "Send dimming value status" chooses "no send, passive stage object". → update value status but no send telegram. 2.The parameter "Send dimming value status" chooses "at change" → send telegram in every dimming value change. 3.The parameter "Send dimming value status" chooses "always at input of telegram" → send telegram in every dimming command. 4.The parameter "Send Status cyclic" is at a certain time value → send telegram at regular intervals.
58	[A:ECG 1] Lock	1 bit	enable (DPT1.003)	CW	0=Unlock; 1=Lock	This object is used to lock/unlock the ECG. Priority: Panic mode > Lock > Night mode
	[A:ECG 1] Lock	1 bit	enable (DPT1.003)	CW	0=Lock; 1=Unlock	This object is used to lock/unlock the ECG. Priority: Panic mode > Lock > Night mode

Num	Object name	Length	DPT	Flag	Function	Description
59	[A:ECG 1] Auto Off	1 bit	enable (DPT1.003)	CW	0=Disable; 1=Enable	This object is used to enable/disable the Auto Off function of the ECG
	[A:ECG 1] Staircase light	1 bit	enable (DPT1.003)	CW	0=Off 1=On	When 'Staircase light' is selected as 'active', enable this object. Value of telegram: 1= enable the staircase light function; 0 = If the parameter 'Manual switching off' is selected as 'active', the staircase light function can be turned off
60	[A:ECG 1] Operation Hours Reset	1 bit	reset (DPT1.015)	CW	1=Reset	Resets the operating hours counter of the ECG.
61	[A:ECG 1] Operation Hours value	4 bytes	time lag(s) (DPT13.100)	CRT	4-Bytes Value in Second	The operating hours of the ECG in seconds are sent via this object. When the parameter "Select data type" is set to "4 Byte value in second(DTP 13.100)", the unit of operation time value is seconds.
	[A:ECG 1] Operation Hours value	2 bytes	enable (DPT1.003)	CRT	2-Bytes Value in Hours	The operating hours of the ECG in hours are sent via this object. When the parameter "Select data type" is set to "2 Byte value in hour (DTP 7.007)", the unit of operation time value is hour.

Num	Object name	Length	DPT	Flag	Function	Description
62	[A:ECG 1] Operation Hours Exceeded	1 bit	enable (DPT1.005)	CRT	0=No Exeeded 1=Exeeded	When the operation hours' counter exceeds the threshold set by the parameter "Operation hours limit" the object will send '1' and the operation hours' counter is reset to 0.
63	[A:ECG 1] Failure (Status)	1 bit	alarm (DPT1.005)	CRT	0=No Error; 1=Error	Detects whether the ECG is disconnected, short circuit or open circuit. As long as one of these situations occurs, the object will report "1", otherwise it will report "0".
64	[A:ECG 1] Converter Test Control	1 byte	converter test control (DPT20.611)	CW	Control Test Command	This object is used to start duration test of the converter, function tests and battery status queries. Furthermore, it allows to stop running test and to reset test flags. These object follows the following coding: Bit 0: Reserved. Bit 1: Start function test Bit 2: Start duration test Bit 3: Start partial duration test Bit 4: Stop test Bit 5: Reset function test done flag Bit 6: Reset duration test done flag Bit 7 – 255: Reserved

Num	Object name	Length	DPT	Flag	Function	Description
65	[A:ECG 1] Converter Status	2 bytes	Dali converter status (DPT244.600)	CRT	Status of a Converter	Converter Mode. This object is used to send the status of a converter with the following coding: Bit 0: Unknown. Bit 1: Normal mode active. Bit 2: Inhibit mode active: for 15 minutes the converter will not switch the emergency lighting on when a power failure occurring. Bit 3: Hardwired inhibit mode active: digital input that the converter can have to activate the inhibit mode. Bit 4: Rest mode active: forced off emergency lighting during emergency mode. Bit 5: Emergency mode active. Bit 6: Extended emergency mode active. Bit 7: FT in progress. Bit 8: DT in progress. Bit 9: PDT in progress. Bit 10 - 15: Reserved. HS: Hardware status. Bit0: Hard connection suppression activation. Bit1: The hard wire switch has been turned on. Bit2, Bit3: Reserved. Equal to 0. FP: Functional testing to be determined. 0: Unknown. 1: No test waiting.

Num	Object name	Length	DPT	Flag	Function	Description
						2: Test waiting. 3: Reserved. DP: Continuous testing to be determined. 0: Unknown. 1: No test waiting. 2: Test waiting. 3: Reserved. PP: Partial duration testing to be determined. 0: Unknown. 1: No test waiting. 2: Test waiting. 3: Reserved. CF: Frequency converter failure. Indicates that one or more faults have been detected. More information about the types of faults can be found in CTR. 0: Unknown. 1: No fault detected. 2: Fault detected. 3: Reserved.

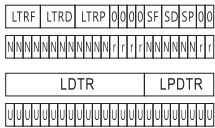
Num	Object name	Length	DPT	Flag	Function	Description
66	[A:ECG 1] Converter Test Result	6 bytes	Dali converter test control (DPT244.600)	CRT	Result of a Test	 <p>This object is used to send the result of the last converter test with the following coding: LTRF, LTRD, LTRP: Last Test Result Function/Duration/Partial duration: Indicates the test result of each type: Bit 0: Unknown. Bit 1: Passed in time. Bit 2: Passed max delay exceeded. Bit 3: Failed, test executed in time. Bit 4: Failed, max delay exceeded. Bit 5: Test manually stopped. Bit 6 - 15: Reserved. SF, SD, SP: Start method of last Function/Duration/Partial test. Indicates the method by which the last test started. Updated when a test is finish. Bit 0: Unknown. Bit 1: Started automatically. Bit 2: Started by Gateway. Bit 3: Reserved. LDTR: Last Duration Test Result. Contains the battery discharge</p>

Num	Object name	Length	DPT	Flag	Function	Description
						time as the result of the last successful duration test indicated in minutes. LPDTR: Last Partial Duration Test Result. Provides the remaining battery charge level after the last partial duration test. bit 0: Deep discharge point. Bit 1 - 253: Battery level. Bit 254: Fully charged. Bit 255: Unknown.

Num	Object name	Length	DPT	Flag	Function	Description
When "Colour Control Type" is selected as "Colour Temperature":						
64	[A:ECG 1] Relative Colour Temperature	4 bit	dimming control (DPT 3.007)	CW	4-Bit Colour Temperature Control	Relative colour temperature adjustment.
65	[A:ECG 1] Colour Temperature	2 bytes	absolute colour temperature(K) (DPT7.600)	CW	2-Bytes Colour Temperature Control	Absolute colour temperature adjustment
66	[A:ECG 1] Colour Temperature Value (Status)	2 bytes	absolute colour temperature(K) (DPT7.600)	CRT	1000-10000K	Feedback the colour temperature value of the ECG
When "Colour Control Type" is selected as "Colour RGB":						
65	[A:ECG 1] Colour RGB	3 bytes	RGB value 3x (DPT232.600)	CW	3-Bytes Colour RGB Control	Set the RGB value of the ECG
66	[A:ECG 1] Colour RGB Value (Status)	3 bytes	RGB value 3x (DPT232.600)	CRT	3-Bytes Colour RGB Value	Feedback the RGB value of the ECG
When "Colour Control Type" is selected as "Colour RGBW":						
65	[A:ECG 1] Colour RGBW	6 bytes	RGBW value 4x (DPT251.600)	CW	6-Bytes Colour RGBW Control	Set the RGBW value of the ECG
66	[A:ECG 1] Colour RGBW Value (Status)	6 bytes	RGBW value 4x (DPT251.600)	CRT	6-Bytes Colour RGBW Value	Feedback the RGBW value of the ECG

Num	Object name	Length	DPT	Flag	Function	Description
When "Colour Control Type" is selected as "Colour xy-coordinate":						
65	[A:ECG 1] Colour xy-coordinate	6 bytes	colour xy-coordinate (DPT242.600)	CW	6-Bytes Colour xy-coordinate Control	Set the xy-coordinate value of the ECG
66	[A:ECG 1] Colour xy-coordinate Value (Status)	6 bytes	colour xy-coordinate 4x (DPT242.600)	CRT	6-Bytes Colour xy-coordinate Value	Feedback the xy-coordinate value of the ECG.
67	[A:ECG 1] Staircase prewarning	1 bit	alarm (DPT1.005)	CRT	Alarm	When the prewarning mode is enabled, the object is enabled. After the staircase light time ends, the object sends '1'. After the prewarning time ends, the channel is closed and the object sends '0'
Please refer to the above ECG 1 for the objects description of the ECG 2 to ECG 64 channels in the DALIA bus						

Num	Object name	Length	DPT	Flag	Function	Description
1013	[A:Group1] On/Off	1bit	Switch (DPT1.001)	CW	0 = Off; 1 = On	Use this object to switch the Group on or off. The dimming value is set by the parameters "Switch-On value" and "Switch-off value"
	[A:G1] Permanent ON	1bit	Switch (DPT1.001)	CW	0 = Off; 1 = On	When 'Staircase light' is selected as 'active', enable this object. Telegram value: 1= entering Permanent ON mode; 0=Exit Permanent ON mode
1014	[A:Group1] Relative Dimming	4 bit	4 bit Dimming control (DPT 3.007)	CW	4-Bit Dimming Control	This object is used for the relative dimming of the Group.
1015	[A:Group1] Absolute Dimming	1 byte	Percentage (DPT5.001)	CW	1-Byte Dimming Control	This object is used for the absolute dimming of the Group.
1016	[A:Group1] On/Off(Stat us)	1bit	Switch (DPT1.001)	CRT	0 = Off; 1 = On	Sends the on/off status of the Group. 1.The parameter "Send On/Off Status "chooses"no send, passive stage object"→ update status but no send telegram 2.The parameter "Send On/Off Status "chooses"at change"→ send telegram in every on/off change. 3.The parameter "Send On/Off Status "chooses"always at input of telegram".→ send telegram in every on/off command. 4.The parameter "Send Status cyclic" is at a certain time value→ send telegram at

Num	Object name	Length	DPT	Flag	Function	Description
						regular intervals. Note: When dimming value>0, the current state is On, and when dimming value=0, the current state is Off.
1017	[A:Group1] Dimming Value (Status)	1 byte	Percentage (DPT5.001)	CRT	0-100%	Sends the dimming value of the Group. 1.The parameter "Send dimming value status" chooses "no send, passive stage object"→ update value status but no send telegram. 2.The parameter "Send dimming value status" chooses"at change"→ send telegram in every dimming value change 3.The parameter "Send dimming value status" chooses"always at input of telegram"→ send telegram in every dimming command. 4.The parameter "Send Status cyclic" is at a certain time value→ send telegram at regular intervals.
1018	[A:Group1] Lock	1 bit	Enable (DPT1.003)	CW	0 = Unlock 1 = Lock	This object is used to lock/unlock the Group Priority: Panic mode> Lock > Night mode.

Num	Object name	Length	DPT	Flag	Function	Description
	[A:Group1] Lock	1 bit	Enable (DPT1.003)	CW	0 = Lock; 1 = Unlock	This object is used to lock/unlock the Group Priority: Panic mode> Lock > Night mode
	[A:Group1] Auto Off	1bit	Enable (DPT1.003)	CW	0 = Disable 1 = Enable	This object is used to enable/disable the Auto Off function of the Group
1019	[A:Group1] Staircase light	1 bit	switch (DPT1.001)	CW	0=Off 1=On	When 'Staircase light' is selected as 'active', enable this object. Value of telegram: 1 = enable the staircase light function; 0 = If the parameter 'Manual switching off' is selectedas 'active', the staircase light function can be turned off
1020	[A:Group1] Operation Hours Reset	1 bit	Reset (DPT1.015)	CW	1 = Reset	Resets the operating hours counter of the Group.
	[A:Group1] Operation Hours Value	4bytes	Time lag(s) (DPT13.100)	CRT	4-Bytes Value in Second	The operating hours of the Group in seconds are sent via this object. When the parameter "Select data type" is set to "4 Byte value in second(DTP 13.100)", the unit of operation time value is seconds.
1021	[A:Group1] Operation Hours Value	2 bytes	Time (h) (DPT7.007)	CRT	2-Bytes Value in Hours	The operating hours of the Group in hours are sent via this object. When the parameter "Select data type" is set to "2 Byte value in hour (DTP 7.007)", the unit of operation time value is hour

Num	Object name	Length	DPT	Flag	Function	Description
1022	[A:Group1] Operation Hours Exceeded	1bit	Alarm (DPT1.005)	CRT	0 = No Exeeded; 1 = Exeeded	When the operation hours' counter exceeds the threshold set by the parameter "Operation hours limit" the object will send '1' and the operation hours' counter is reset to 0.
1023	[A:Group1] Failure (Status)	1 bit	Alarm (DPT1.005)	CRT	0 = No Error; 1 = Error	Detect if there are any ECG drops, short circuits, or open circuits in the group. As long as one of the situations occurs in an ECG in the group, the object will report "1", otherwise it will report "0"
When "Colour Control Type" is selected as "Colour Temperature":						
1024	[A:Group1] Relative Colour Temperature	4bit	dimming control (DPT 3.007)	CW	4-Bit Colour Temperature Control	Relative colour temperature adjustment.
1025	[A:Group1] Colour Temperature	2bytes	absolute colour temperature(K) (DPT7.600)	CW	2-Bytes Colour Temperature Control	Absolute colour temperature adjustment.
1026	[A:Group1] Colour Temperature Value(Status)	2bytes	absolute colour temperature(K) (DPT7.600)	CRT	1000-10000K	Feedback the colour temperature value of the Group.
When "Colour Control Type" is selected as "Colour RGB":						
1025	[A:Group1] Colour RGB	3bytes	RGB value 3x (DPT232.600)	CW	3-Bytes Colour RGB Control	Set the RGB value of the Group
1026	[A:Group1] Colour RGB Value(Status)	3bytes	RGB value 3x (DPT232.600)	CRT	3-Bytes Colour RGB Value	Feedback the RGB value of the Group.

Num	Object name	Length	DPT	Flag	Function	Description
When "Colour Control Type" is selected as "Colour RGBW":						
1025	[A:Group1] Colour RGBW	6bytes	RGBW value 4x (DPT251.600)	CW	6-Bytes Colour RGBW Control	Set the RGBW value of the Group
1026	[A:Group1] Colour RGBW Value(Status)	6bytes	RGBW value 4x (DPT251.600)	CRT	6-Bytes Colour RGBW Value	Feedback the RGBW value of the Group
When "Colour Control Type" is selected as "Colour xy-coordinate":						
1025	[A:Group1] Colour xy-coordinate	6bytes	colour xy-coordinate (DPT242.600)	CW	6-Bytes Colour xy-coordinate Control	Set the xy-coordinate value of the Group.
1026	[A:Group1] Colour xy-coordinate Value(Status)	6bytes	colour xy-coordinate 4x (DPT242.600)	CRT	6-Bytes Colour xy-coordinate Value	Feedback the xy-coordinate value of the Group.
1027	[A:G1] Activate Dim2Warm colour function/ Status	1 bit	enable (DPT1.003)	CRWT	0=Disable; 1=Enable	When 'Use colour function' is set to 'Dim2Warm', this object is enabled. This object blocks or enables the Dim2Warm colour function of the group. Telegram value: 1= activate the automatic Dim2Warm colour function; 0 = disable automatic Dim2Warm colour function
	[A:G1] Activate HCL colour function/ Status	1 bit	enable (DPT1.003)	CRWT	0=Disable; 1=Enable	When 'Use colour function' is set to 'Central colour temperature (HCL)'this object is enabled. This object blocks or enables the HCL colour function of the group. Telegram value: 1= activate the automatic HCL colour function; 0= disable automatic HCL colour function.

Num	Object name	Length	DPT	Flag	Function	Description
1028	[A:G1] Staircase prewarning	1 bit	alarm (DPT1.005)	CRT	Alarm	When the prewarning mode is enabled, the object is enabled. After the staircase light time ends, the object sends '1'. After the prewarning time ends, the channel is closed and the object sends '0'
1029	[A:G1] Scene	1 byte	scene control (DPT18.001)	CW	Scene No.(1...16)	Group scene control, scene numbers 1-16. Note: After using the scene function, do not use the "download" function in the DCA page again, otherwise the scene setting information will be overwritten.
Please refer to the above Group 1 for the objects description of the Group 2 to Group 16 channels in the DALI bus A						
Objects of ECGs and Groups in DALI Bus B segment, please refer to descriptions of those objects in DALI Bus A						
2517	[Relay 1] On/Off	1bit	Switch (DPT1.001)	CW	0 = Off; 1 = On	This object is used to switch the relay on or off
2518	[Relay 1] Lock	1bit	Enable (DPT1.003)	CW	0 = Unlock 1 = Lock	This object is used to lock/unlock the relay
2519	[Relay 1] On/Off (Status)	1bit	Switch (DPT 1.001)	CRT	0 = Off; 1 = On	This object is used to send the status of the relay
2520	[Relay 1] On/Off (Inverted Status)	1bit	switch (DPT 1.001)	CRT	0 = Off; 1 = On	This object is used to send the inverted status of the relay. Note: This object is only valid when the parameter "Additional inverted state" is checked

Num	Object name	Length	DPT	Flag	Function	Description
2521	[Relay 1] Forced Control	2bit	Switch control (DPT2.001)	CW	2-Bit Forced Control	Forced control function 00 and 01: Deactivates Forced control 10: Sets to Forced control active with relay Off (open). 11: Sets to Forced control active with relay On (short). Note: Priority: Lock > Priority/Force control
	[Relay 1] Priority	1bit	switch (DPT1.001)	CW	1-Bit Priority ON	Activates or deactivates forced On function. Relay On (short) when activated. Note: Priority: Lock > Priority/Force control
	[Relay 1] Priority	1bit	switch (DPT1.001)	CW	1-Bit Priority OFF	Activates or deactivates forced Off function. Relay Off (open) when activated. Note: Priority: Lock > Priority/Force control
Please refer to the above Relay 1 for the objects description of the Relay 2 to Relay 4.						
2537	[Seq 1] Start/Stop	1bit	start/stop (DPT 1.001)	CW	0 = Stop 1 = Start	Activate or deactivates the Sequence 1. Note: This object is only valid when the parameter "Sequence 1" is checked
Please refer to the above Seq 1 for the objects description of the Seq 2 to Seq 16						
2553	[Timer 1] Object-1 Switch	1 bit	switch (DPT 1.001)	CRT	0 = Off 1 = On	This object is used to send on/off signals of the timer when it is triggered. This object only available when the parameter "Object -1 Type" chooses " Switch (DPT1.001)"

Num	Object name	Length	DPT	Flag	Function	Description
2553	[Timer 1] Object-1 Percentage	1 bit	percentage (DPT 5.001)	CRT	0-100%	This object is used to send dimming signals of the timer when it is triggered. This object only available when the parameter "Object -1 Type" chooses "Percentage(DPT5.001)"
	[Timer 1] Object-1 Colour Temperature	2bytes	absolute colour temperature(K) (DPT 7.600)	CRT	1000-10000K	This object is used to send colour temperature signals of the timer when it is triggered. This object only available when the parameter "Object-1 Type" chooses "Colour Temperature(DPT7.600)"
	[Timer 1] Object-1 Colour RGB	3bytes	RGB value 3x (DPT 232.600)	CRT	3-Bytes Colour RGB value	This object is used to send RGB signals of the timer when it is triggered. This object only available when the parameter "Object-1 Type" chooses "Colour RGB (DPT232.600)".
	[Timer 1] Object-1 Colour RGBW	6bytes	RGBW value 4x (DPT 251.600)	CRT	6-Bytes Colour RGBW value	This object is used to send RGBW signals of the timer when it is triggered. This object only available when the parameter "Object-1 Type" chooses "Colour RGBW (DPT251.600)".
	[Timer 1] Object-1 Colour xy-coordinate	6bytes	colour xy-coordinate (DPT 242.600)	CRT	6-Bytes Colour xy-coordinate value	This object is used to send xy-coordinate signals of the timer when it is triggered. This object only available when the parameter "Object-1 Type" chooses "Colour xy-coordinate (DPT242.600)".

Num	Object name	Length	DPT	Flag	Function	Description
2553	[Timer 1] Object-1 Scene Control	1 byte	scene number (DPT 18.001)	CRT	1-64	This object is used to trigger scene of the timer when it is triggered. This object only available when the parameter "Object -1 Type" chooses "Scene Number(DPT17.001)"
2554	[Timer 1] Object-2 Switch	1 bit	switch (DPT 5.001)	CRT	0=Off 1=On	This object is used to send on/off signals of the timer when it is triggered. This object only available when the parameter "Object -2 Type" chooses "Switch (DPT1.001)"
	[Timer 1] Object-2 Percentage	3bytes	Percentage (DPT 5.001)	CRT	0-100%	This object is used to send dimming signals of the timer when it is triggered. This object only available when the parameter "Object -2 Type" chooses "Percentage(DPT5.001)"
	[Timer 1] Object-2 Colour Temperature	2 bytes	absolute colour temperature(K) (DPT 7.600)	CRT	1000-10000K	This object is used to send colour temperature signals of the timer when it is triggered. This object only available when the parameter "Object-2 Type" chooses "Colour Temperature(DPT7.600)"
	[Timer 1] Object-2 Colour RGB	3 bytes	RGB value 3x (DPT 232.600)	CRT	3-Bytes Colour RGB value	This object is used to send RGB signals of the timer when it is triggered. This object only available when the parameter "Object-21 Type" chooses "Colour RGB (DPT232.600)"

Num	Object name	Length	DPT	Flag	Function	Description
2554	[Timer 1] Object-2 Colour RGBW	6bytes	RGBW value 4x (DPT 251.600)	CRT	6-Bytes Colour RGBW value	This object is used to send RGBW signals of the timer when it is triggered. This object only available when the parameter "Object-2 Type" chooses "Colour RGBW (DPT251.600)"
	[Timer 1] Object-2 Colour xy-coordinate	6bytes	colour xy-coordinate (DPT 242.600)	CRT	6-Bytes Colour xy-coordinate value	This object is used to send xy-coordinate signals of the timer when it is triggered. This object only available when the parameter "Object-2 Type" chooses "Colour xy-coordinate (DPT242.600)"
	[Timer 1] Object-2 Scene Control	1byte	scene number (DPT 18.001)	CRT	1-64	This object is used to trigger scene of the timer when it is triggered. This object only available when the parameter "Object -2 Type" chooses "Scene Number (DPT17.001)"

Num	Object name	Length	DPT	Flag	Function	Description
2555	[Timer 1] Object-3 Switch	1 bit	switch (DPT 1.001)	CRT	0 = Off; 1 = On	This object is used to send on/off signals of the timer when it is triggered. This object only available when the parameter "Object -3 Type" chooses "Switch (DPT1.001)"
	[Timer 1] Object-3 Percentage	1byte	percentage (DPT 5.001)	CRT	0-100%	This object is used to send dimming signals of the timer when it is triggered. This object only available when the parameter "Object-3 Type" chooses "Percentage(DPT5.001)"
	[Timer 1] Object-3 Colour Temperature	2bytes	absolute colour temperature(K) (DPT 7.600)	CRT	1000-10000K	This object is used to send colour temperature signals of the timer when it is triggered. This object only available when the parameter "Object-3 Type" chooses "Colour Temperature(DPT7.600)"
	[Timer 1] Object-3 Colour RGB	3bytes	RGB value 3x (DPT 232.600)	CRT	3-Bytes Colour RGB value	This object is used to send RGB signals of the timer when it is triggered. This object only available when the parameter "Object -3 Type" chooses "Colour RGB (DPT232.600)"

Num	Object name	Length	DPT	Flag	Function	Description
2555	[Timer 1] Object-3 Colour RGBW	6bytes	RGBW value 4x (DPT 251.600)	CRT	6-Bytes Colour RGBW value	This object is used to send RGBW signals of the timer when it is triggered. This object only available when the parameter "Object -3 Type" chooses "Colour RGBW (DPT251.600)"
	[Timer 1] Object-3 Colour xy-coordinate	6bytes	colour xy-coordinate (DPT 242.600)	CRT	6-Bytes Colour xy-coordinate value	This object is used to send xy-coordinate signals of the timer when it is triggered. This object only available when the parameter "Object -3 Type" chooses "Colour xy-coordinate (DPT242.600)"
	[Timer 1] Object-3 Scene Control	1byte	scene number (DPT 18.001)	CRT	1-64	This object is used to trigger scene of the timer when it is triggered. This object only available when the parameter "Object-3 Type" chooses "Scene Number(DPT17.001)"

Num	Object name	Length	DPT	Flag	Function	Description
2556	[Timer 1] Object-4 Switch	1bit	switch (DPT 1.001)	CRT	0 = Off; 1 = On	This object is used to send on/off signals of the timer when it is triggered. This object only available when the parameter "Object -4 Type" chooses "Switch (DPT1.001)"
	[Timer 1] Object-4 Percentage	1byte	percentage (DPT 5.001)	CRT	0-100%	This object is used to send dimming signals of the timer when it is triggered. This object only available when the parameter "Object -4 Type" chooses "Percentage (DPT5.001)"
	[Timer 1] Object-4 Colour Temperature	2bytes	absolute colour temperature(K) (DPT 7.600)	CRT	1000-10000K	This object is used to send colour temperature signals of the timer when it is triggered. This object only available when the parameter "Object-4 Type" chooses "Colour Temperature(DPT7.600)'
	[Timer 1] Object-4 Colour RGB	3bytes	RGB value 3x (DPT 232.600)	CRT	3-Bytes Colour RGB value	This object is used to send RGB signals of the timer when it is triggered. This object only available when the parameter "Object-4 Type" chooses "Colour RGB(DPT232.600)"
	[Timer 1] Object-4 Colour RGBW	6bytes	RGBW value 4x (DPT 251.600)	CRT	6-Bytes Colour RGBW value	This object is used to send RGBW signals of the timer when it is triggered. This object only available when the parameter "Object -4 Type" chooses "Colour RGBW (DPT251.600)"

Num	Object name	Length	DPT	Flag	Function	Description
2556	[Timer 1] Object-4 Colour xy-coordinate	6bytes	colour xy-coordinate (DPT 242.600)	CRT	6-Bytes Colour xy-coordinate value	This object is used to send xy-coordinate signals of the timer when it is triggered. This object only available when the parameter "Object-4 Type" chooses "Colour xy-coordinate(DPT242.600)"
	[Timer 1] Object-4 Scene Control	1byte	scene number (DPT 18.001)	CRT	1-64	This object is used to trigger scene of the timer when it is triggered. This object only available when the parameter "Object-4 Type" chooses "Scene Number(DPT17.001)"

Please refer to the above Timer 1 for the objects description of the Timer 2 to Timer 16.

7. Display

The display on the DLC-02-KN can parameterize maximum level, minimum level, fade rate/time, group and scenes and set the system time, as well as turn on/off relay.

- The main page displays product model, time and date

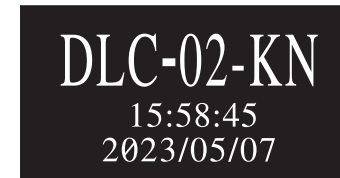

- A new menu appears when one of the MOVE/SET/ESC buttons is pressed, as shown in the picture below.

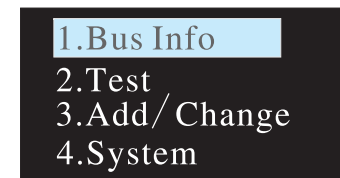

Menu Structure

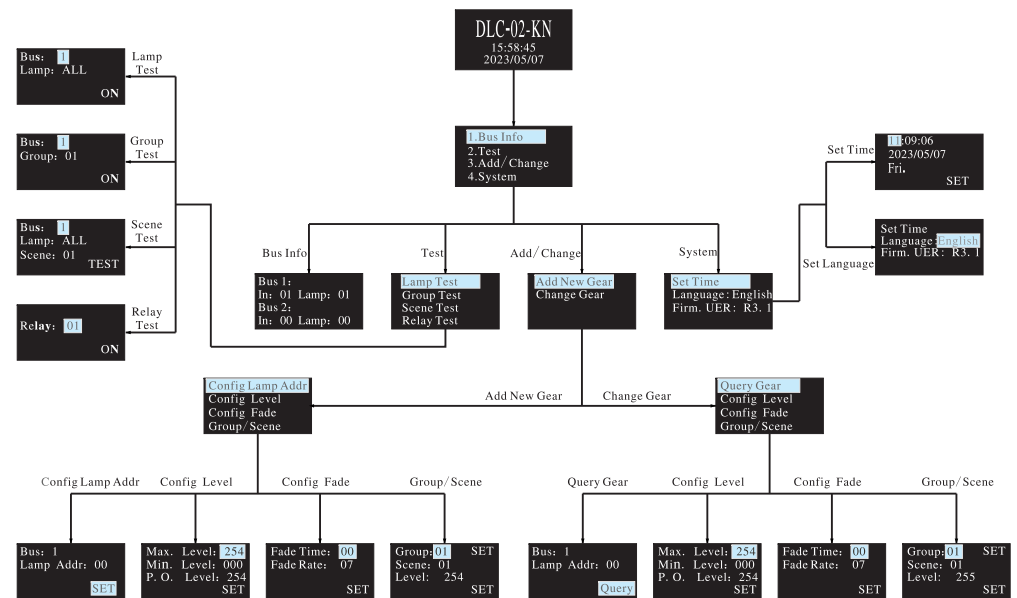

7.1 Bus Info

The menu is used to scan total quantity of input and output devices connected to the controller. The example below shows there is one input device and one output device in Bus A and no any device found in Bus B.

```
Bus 1:  
In: 01 Lamp: 01  
Bus 2:  
In: 00 Lamp: 00
```

7.2 Test

- Press MOVE button to move the indicator onto Test, then press SET button to enter the menu, shown as below.
- The menu includes Lamp test, Group test, Scene test and Relay test.

```
Lamp Test  
Group Test  
Scene Test  
Relay Test
```

The operation instructions are shown as follows:

7.2.1 Lamp test: used to turn ON/OFF or flash a single lamp or all of the lamps on Bus A and B. Bus: 1 represents DALI-A, 2 represents DALI-B; Lamp: 00 – 63 represents name of a single lamps, ALL represents all of the lamps.

```
Bus: 1  
Lamp: ALL  
  
ON
```

7.2.2 Group test: used to turn ON/OFF or flash a group of lamps on Bus A and B. Bus: 1 represents DALI-A, 2 represents DALI-B; Group: 01 – 16 represents name of groups.

```
Bus: 1  
Group: 01  
  
ON
```

7.2.3 Scene Test

- Set a single lamp or all of the lamps on the DALI A/B to a specific scene.
- Bus: 1 represents DALI-A, 2 represents DALI-B.
- Lamp: 00 – 63 represents name of a single lamps, ALL represents all of the lamps; Scene: 01 – 16 represents name of scenes.

```
Bus: 1  
Lamp: ALL  
Scene: 01  
  
TEST
```

7.2.4 Relay test

- Test ON/OFF functions of the 4 relays
- Relay: 01 – 04 represents name of the relays; ON/OFF: ON makes relay short and the corresponding indicator lights up, OFF make relay open and the corresponding indicator switches off.

```
Relay: 01  
  
ON
```

7.3 Add/Change

```
Add New Gear  
Change Gear
```

7.3.1 Add New Gear:

It is used to add new devices to the DALI system and parameterize maximum level, minimum level, power on level, fade time, fade rate, group and scene of the new devices

```
Config Lamp Addr  
Config Level  
Config Fade  
Group/Scene
```

The operation instructions are shown as follows:

①Config Lamp Addr

Set short address 0-63, select "SET" to complete the setting. The set lamp must be a device that has not been assigned any address, otherwise it will display fail. Bus: 1 represents DALI-A, 2 represents DALI-B; Lamp addr: 00 – 63 represents a short address for the new device.

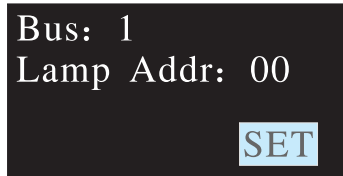

②Config Lamp Level

Parameterize maximum level, minimum level for the new device, select "SET" to complete the setting. (All levels should be larger or equal to physical min level, otherwise setting will fail)

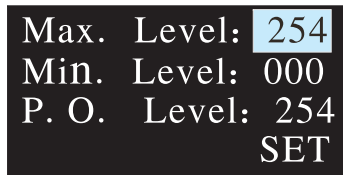

③Config Fade

- Parameterize fade time and fade rate for the new device.
- Fade time defines the time needed to achieve the required setting after receiving a DAPC command. It is mainly used for absolute dimming, such as go to scene or go to last active level.

Fade times in seconds:

Index	00	01	02	03	04	05	06	07
Fade Time(s)	0	0.7	1.0	1.4	2.0	2.8	4.0	5.7

Index	08	09	10	11	12	13	14	15
Fade Time(s)	8.0	11.3	16.0	22.6	32.0	45.3	64.0	90.5

- Fade rate defines the rate at which changes are made (in steps per second) in the value of the lamp's power. It is mainly used for relative dimming, such as up or down.

Fade rates in steps/second:

Index	01	02	03	04	05	06	07	08
Fade rate (step/s)	358	253	179	127	89	63	45	32

Index	09	10	11	12	13	14	15
Fade rate (step/s)	22	16	11.2	7.9	5.6	4.0	2.8

④Group/Scene

Assign a group and set a scene for the new device. Group: 01 -16 represents name of groups; Scene: 01 -16 represents name of scene; Level: 0 – 254 represents light levels.

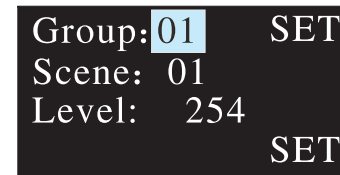

7.3.2 Change Gear

- It is used to change maximum level, minimum level, power on level, fade time, fade rate, group and scene of the existed devices on the buses.
- The operation method is the same as Add New Gear, please refer to 7.3.1 for detailed instructions.

7.4 System

Functions include time calibration, language change and firmware version display.

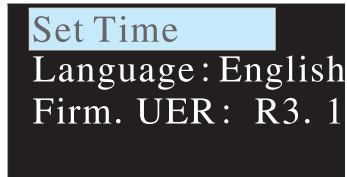

7.4.1 Set Time:

- ① Press MOVE button to move the indicator on HH/MM/SS/yyyy/mm/dd.
- ② Press SET button to adjust values.
- ③ Select "SET" when finishing setting.



7.4.2 Language:

There are two language options available: English and Simplified Chinese.

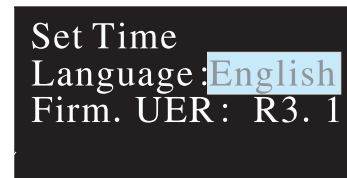

7.4.3 Firm VER:

It displays firmware version of the DLC-02-KN



8. Warranty

This product provides five years warranty under normal usage. Do not replace parts or any form of modification to the product in order to keep the warranty effectively.

- ※ MEAN WELL possesses the right to adjust the content of this manual. Please refer to the latest version of our manual on our website. <https://www.meanwell.com>



9. Environmental declaration information

https://www.meanwell.com//Upload/PDF/RoHS_PFOS.pdf
https://www.meanwell.com//Upload/PDF/REACH_SVHC.pdf
https://www.meanwell.com//Upload/PDF/Declaration_RoHS-E.pdf

明緯企業股份有限公司

MEAN WELL ENTERPRISES CO., LTD.

248 新北市五股區五權三路28號

No.28, Wuquan 3rd Rd., Wugu Dist., New Taipei City 248, Taiwan

Tel: 886-2-2299-6100 Fax: 886-2-2299-6200

<http://www.meanwell.com> E-mail: info@meanwell.com